



VMU-C EM



Web Server system for energy monitoring

Instruction manual

Version A14

TABLE OF CONTENTS

1	INSTALLATION	5
1.1	PRELIMINARY REMARKS	5
1.2	PACKAGE CONTENT	5
1.3	TECHNICAL FEATURES	6
1.4	INSTALLATION AND CONNECTIONS.....	7
2	GENERAL OVERVIEW	9
2.1	VMU-C EM	9
2.2	ACCESS TO THE SYSTEM	9
2.3	HOME PAGE.....	11
2.3.1	NAVIGATION MENU.....	14
3	SETTINGS	15
3.1	SYSTEM CONFIGURATION	15
3.1.1	PLANT DATA SETTING	16
3.1.2	LAN SETTING	18
3.1.3	NTP SERVER SETTING	20
3.1.4	DP SERVICE SETTING	21
3.1.5	FTP SERVICE CONFIGURATION.....	25
3.1.6	MODBUS TCP SLAVE	28
3.1.7	MODBUS TCP MASTER.....	31
3.1.8	THE VMU-W MODEM	31
3.1.9	ALARM SENDING CONFIGURATION	36
3.1.10	PLANNING CONFIGURATION	38
3.1.11	E-MAIL (OUTGOING MAIL SERVER) CONFIGURATION.....	41
3.1.12	UPDATING THE VMU-C FIRMWARE.....	42
3.1.13	TOOLS	46
3.1.14	LANGUAGE SETTING.....	49
3.1.15	WEB SERVER SETTING	50
3.2	PLANT CONFIGURATION	51
3.2.1	COM SETUP.....	51
3.2.2	DRIVERS	52
3.2.3	PLANT SETTING.....	53
3.2.4	CONFIGURATION OF THE VMU-O MODULES (VMU-O EM)	55
3.2.5	ENERGY METER CONFIGURATION	57
3.2.6	COUNTERS CONFIGURATION	64
3.2.7	ENERGY METER DELETION	65
3.2.8	ENERGY METER SUBSTITUTION	66
3.3	VMU-P MODULE CONFIGURATION	67
3.3.1	ALARM CONFIGURATION ON VMU-P MODULES.....	68
3.4	VMU-O MODULE OUTPUT MANUAL COMMAND CONFIGURATION	70
3.5	CONFIGURATION OF THE VMU-M EM MODULES.....	71
3.6	CONFIGURATION OF THE VMU-C EM MODULE	73
3.7	SENDING THE SYSTEM CONFIGURATION.....	75
3.7.1	RESUME (SYSTEM) CONFIGURATION.....	76
3.7.2	IMPORT (SYSTEM CONFIGURATION)	76
3.8	“OTHER VARIABLES” SETTING	77
4	HOME PAGE.....	79
4.1	HOME PAGE – LOAD PROFILE.....	79
5	MONITOR - METER DATA ANALYSIS.....	82
5.1	“CURRENTS” CHART	85
5.2	“POWER FACTORS” CHART.....	86

5.3	"VOLTAGES" CHART	87
5.4	"POWER" CHART	88
5.5	"ANALOGUE VARIABLES" CHART	89
5.6	DC MAIN METER CHARTS	91
5.7	ENERGY SUMMARY	92
5.7.1	<i>Energy Summary configuration</i>	94
6	PLANT DATA CHARTS	95
6.1	ENERGY DATA	96
6.1.1	<i>MAIN METER</i>	96
6.1.2	<i>ENERGY METERS (PARTIAL)</i>	99
6.2	COUNTERS (GENERIC FROM DIGITAL INPUTS)	100
6.3	TRENDS	104
6.3.1	<i>Trends Editing</i>	104
6.3.2	<i>Trends Displaying</i>	106
6.4	REAL TIME VARIABLES	107
6.5	OTHER VARIABLES	109
6.5.1	<i>ANALOGUE INPUT</i>	109
6.5.2	<i>TEMPERATURE</i>	111
6.5.3	<i>PULSE RATE INPUT</i>	112
7	GENERAL CHART FEATURES	115
7.1	ZOOM FEATURE	115
7.2	REFRESH FEATURE	116
7.3	PRINT FEATURE	116
7.4	CHART ACTION MENU	117
8	ALARMS	118
8.1	COMMANDS	120
9	ECONOMIC ANALYSIS	123
10	INFORMATION	125
10.1	VMU-C STATUS	126
10.2	PLANT CHARACTERISTICS	127
10.3	DATABASE CHARACTERISTICS	128
11	DATA EXPORT	130
11.1	EXPORTING DATA	131
11.2	TEMPLATES	132
11.1	SCHEDULES	133
12	ACCOUNT	136
12.1	ACCOUNT MANAGEMENT	136
12.2	ADDING A NEW ACCOUNT	137
12.3	UPDATING AN ACCOUNT	137
12.4	DELETING AN ACCOUNT	138
12.5	LOGGING OFF AN ACCOUNT	138
12.6	HISTORY OF ACCESSES TO THE SYSTEM	138
13	DATA BACK-UP	140
13.1	RESTORING THE CONFIGURATION FROM BACK-UP (FROM FILE)	144
13.2	RESTORING THE DATA-BASE FROM BACK-UP (DISASTER RECOVERY)	145
13.2.1	<i>CONFIGURATION RESTORE</i>	145
13.2.2	<i>DATABASE RESTORE (Disaster Recovery)</i>	146
14	MODBUS DRIVER EDITOR	147
14.1	ABSTRACT	147

14.2	MDE LAUNCHING	147
14.3	MDE OVERVIEW.....	148
14.3.1	<i>MDE List view</i>	<i>148</i>
14.3.2	<i>Functions available in the MDE's LIST view</i>	<i>148</i>
14.3.3	<i>Drivers' status in the MDE LIST view</i>	<i>149</i>
14.3.4	<i>MDE Tree view.....</i>	<i>149</i>
14.4	USING THE MDE	150
14.4.1	<i>Creating a driver.....</i>	<i>150</i>
14.4.2	<i>Deleting a driver.....</i>	<i>150</i>
14.4.3	<i>Copying a driver.....</i>	<i>150</i>
14.4.4	<i>Building a driver.....</i>	<i>150</i>
14.4.5	<i>Exporting a driver</i>	<i>150</i>
14.4.6	<i>Testing a driver.....</i>	<i>151</i>
14.4.7	<i>Configuring communication parameters.....</i>	<i>152</i>
14.4.8	<i>Adding/editing/deleting/saving a configuration.....</i>	<i>153</i>
14.4.9	<i>Adding/editing/deleting/saving a group.....</i>	<i>154</i>
14.4.10	<i>Adding/editing/deleting/saving a variable</i>	<i>155</i>
14.4.11	<i>Adding/editing/deleting/saving a Trend.....</i>	<i>156</i>
15	USER INTERFACE CUSTOMIZATION	158
15.1	ABSTRACT.....	158
15.2	LOGO CUSTOMIZATION.....	159
15.3	HOME CONFIGURATION.....	161
16	IOT FUNCTIONS.....	163
16.1	ABSTRACT.....	163
16.2	VMU-C IS MICROSOFT AZURE CERTIFIED FOR IOT.....	163
16.2.1	<i>Connection to MICROSOFT AZURE IOT.</i>	<i>163</i>
17	DATACENTER APPLICATIONS	165
17.1	INTRODUCTION AND FIELD OF APPLICATION	165
17.2	THE SOLUTION	166
17.3	PRECONDITIONS.....	166
17.4	PAPER LIST DRAWING UP STAGE	167
17.5	USER INTERFACE DESCRIPTION	168
17.5.1	<i>Fields of the table in the Datacenter function</i>	<i>168</i>
17.5.2	<i>Colour code of the Datacenter function rows.....</i>	<i>169</i>
17.5.3	<i>Action Menu of the Datacenter function.....</i>	<i>170</i>
17.6	COMMISSIONING PROCEDURE.....	171
17.6.1	<i>Configuration function preparation.....</i>	<i>171</i>
17.6.2	<i>Entering SINS through a barcode reader</i>	<i>172</i>
17.6.3	<i>RS485 network scan</i>	<i>172</i>
17.6.4	<i>Activating the data reading mode.....</i>	<i>173</i>
17.7	FILING OF COMMISSIONING DOCUMENTS	174
17.8	SUBSEQUENT EDITING OF PARAMETERS.....	174
17.9	MODBUS/TCP MAP	175

1 INSTALLATION

1.1 PRELIMINARY REMARKS

This manual provides a comprehensive guide to VMUC-C EM (WebServer) installation, configuration and commissioning; it is addressed to technical staff members having an average knowledge of IT and of TCP/IP networking basic principles.

VMUC is a web server and provides a comprehensive monitoring system for devices like power analysers (WM series), electric power meters (EM series), water/gas meters and environmental sensors.

The software and all the components needed for panel operation require no installation of additional software components.

1.2 PACKAGE CONTENT

VMU-C EM is supplied in its package, along with the following items:

- VMU-C Web Server
- Installation manual

1.3 TECHNICAL FEATURES

VMUC-EM is micro PC, totally fanless and without any moving components, providing WebServer functions; thanks to the use of industrial hardware, to its extremely small size and to its low energy consumption it is ideal for monitoring applications requiring features like sturdiness and reliability along time; it can be installed in both technical and residential environments, without requiring any special caution during installation, usage and maintenance.

The following table provides a summary list of the product characteristics:

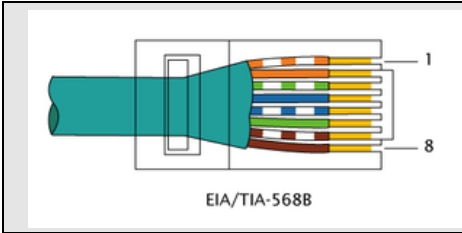
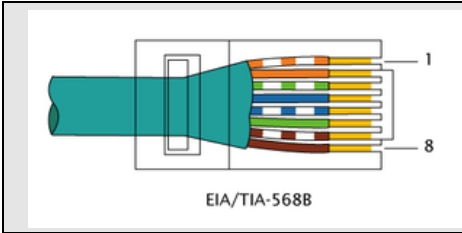
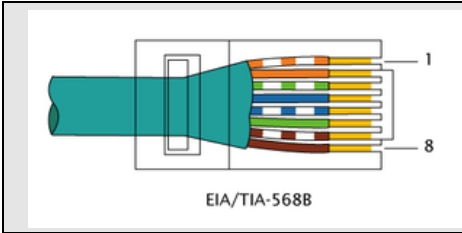
<p>Ports and connections</p>	<p>1 X 12 to 28Vdc power supply (A1+ and A2-) 2 X RS-485 (COM1 and COM2) :</p> <table border="1" data-bbox="609 714 892 911"> <tr> <td rowspan="3">COM1</td> <td>Data - (A-)</td> </tr> <tr> <td>Data + (B+)</td> </tr> <tr> <td>GND</td> </tr> <tr> <td rowspan="3">COM2</td> <td>Data - (A-)</td> </tr> <tr> <td>Data + (B+)</td> </tr> <tr> <td>GND</td> </tr> </table> <p>1 X RJ-45 connector for 10/100 Base-T Ethernet [Communication] [Communication port – Default IP: 192.168.1.110]</p> <table border="1" data-bbox="563 1003 1358 1234"> <tr> <td rowspan="4">  </td> <td>Pin 1 TX+</td> </tr> <tr> <td>Pin 2 TX-</td> </tr> <tr> <td>Pin 3 Rx+</td> </tr> <tr> <td>Pin 6 Rx-</td> </tr> </table> <p>1 X standard USB 1 X mini USB (through a dedicated driver it allows to access the system through the IP address 192.168.254.254) 1 X slot for micro SD or SDHC memory card</p>	COM1	Data - (A-)	Data + (B+)	GND	COM2	Data - (A-)	Data + (B+)	GND		Pin 1 TX+	Pin 2 TX-	Pin 3 Rx+	Pin 6 Rx-
COM1	Data - (A-)													
	Data + (B+)													
	GND													
COM2	Data - (A-)													
	Data + (B+)													
	GND													
	Pin 1 TX+													
	Pin 2 TX-													
	Pin 3 Rx+													
	Pin 6 Rx-													
<p>Absorption</p>	<p>5W Max.</p>													
<p>Operating conditions</p>	<p>-25°C to 40°C</p>													
<p>COM port termination</p>	<p>Both COM ports are internally terminated with a value of 150Ω and polarised with two 511Ω resistors (from “B+” to +5V and from “A-” to GND). As a consequence no other external connection is required.</p>													

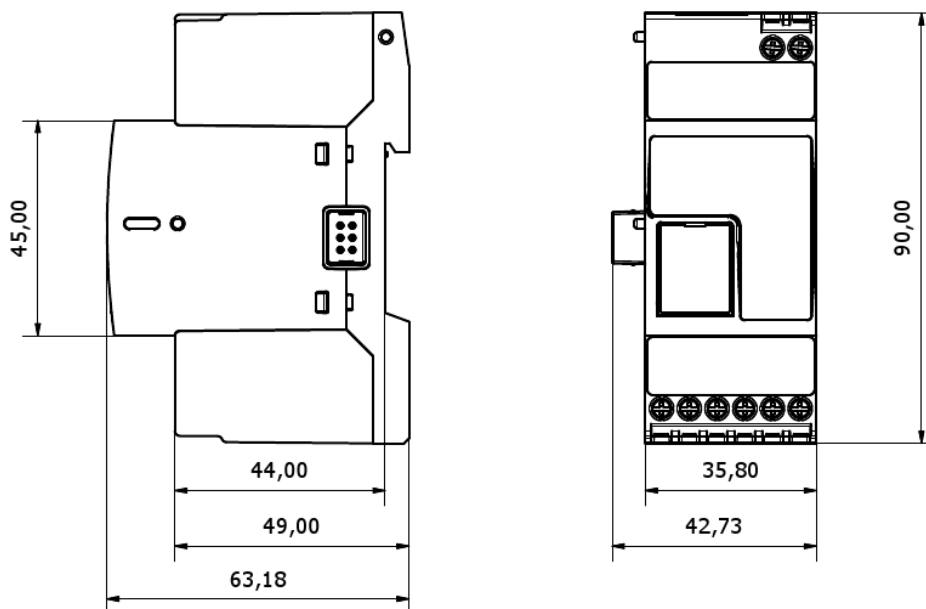

Fig. 1 – Eos-Box dimensions

1.4 INSTALLATION AND CONNECTIONS

To install VMU-C EM you need to perform the following steps:

- Connect the DC 24Vdc power supply (12Vdc to 28Vdc) through an appropriately sized feeder (recommended feeders: CG, SPM or SPD series)
- COM1: communication port for the connection to the RS-485 bus for VMUM-EM temperature measurement master devices (Pt100 or Pt1000; 2 or 3 wires), analogue inputs (mV or mA) or for digital input status monitoring (open/closed).

You may connect up to 10 VMU-M EM systems with the relevant VMU-P EM and/or VMU-O EM modules.

VMU-C

All the VMU-M EM devices connected to the COM1 port will have to be set to the same baud rate.

- COM2: communication port for the connection on RS-485 bus of the electric power meters. The cascade-connected devices can communicate at different baud rates (communication speeds) while using different communication addresses.

You may connect up to 32 instruments (meters and/or analysers).

The following figure lists the compatible instruments as of the current date:

AVAILABLE DRIVER LIST			
BRAND	DRIVER	VERSION	INSTRUMENT
CARLO GAVAZZI	EM12	1.2	Energy Meter
CARLO GAVAZZI	EM21	2.3	Energy Meter
CARLO GAVAZZI	EM21_R	1.2	Energy Meter
CARLO GAVAZZI	EM23	1.1	Energy Meter
CARLO GAVAZZI	EM24	1.1	Energy Meter
CARLO GAVAZZI	EM26	1.1	Energy Meter
CARLO GAVAZZI	EM33	2.1	Energy Meter
CARLO GAVAZZI	VMU-E_DIRECT	1.1	Energy Meter
CARLO GAVAZZI	VMU-E_SENSOR	1.1	Energy Meter
CARLO GAVAZZI	VMU-E_SHUNT	1.1	Energy Meter
CARLO GAVAZZI	WM30	2.2	Energy Meter
CARLO GAVAZZI	WM40	2.3	Energy Meter

List of the available energy meter drivers

The log data recorded throughout the day shall be available to be shown in graphical form for 6 months.

The daily data, that is the summary values of each day shall be available to be shown in graphical form for 10 years.

- Connect the system to the data network through a standard Ethernet cable, using the LAN communication port configured with the default static IP address 192.168.1.110
- Connect the GPRS/EDGE/UMTS/HSDPA modem by means of the VMU-W module through inner bus (optional).

Once power is supplied to the VMU-C EM, the following LEDs will light up on the front panel: green "ON" LED (indicating the machine is powered), orange "BUS" LED (indicating inner BUS activity), orange "COM1" and COM2 LEDs (indicating COM door activity), blue "USB" LED (indicating the presence of an USB device) and red "AL" LED (indicating the presence of any alarm condition); when connecting the network cable, the Ethernet port LEDs will light up as well.

After connecting and powering the VMU-C, access its configuration Web pages as described in the next chapter.

2 GENERAL OVERVIEW

2.1 VMU-C EM

VMU-C is conventional energy monitoring Web server based on Web technology. Once properly set up, the VMU-C EM software can be used through the net – both LAN and Internet – through any PC or device equipped with a common Internet browser.

As VMU-C EM is based on the Web technology, it can be used as an ordinary Web site; the data and status display function for the devices installed in the plant (analysers, meters, environmental sensors) is based on the innovative AJAX technology, allowing to send and receive information without having to reload the graphical pages.

2.2 ACCESS TO THE SYSTEM

To access the system, you first need to establish a network connection between your PC and VMU-C EM, using the LAN port existing on the device; you have the following options:

- Directly connect the two devices (VMU-C EM and PC) through a network cable
- Connect both devices (VMU-C EM and PC) to your local network
- Directly connect the two devices (VMU-C EM and PC) through a USB/mini-USB cable.

The VMU-C EM default address is **192.168.1.110**; in any connection configuration; this implies that, in order to be able to communicate with VMU-C, your PC must belong to the same sub-network; that means its IP address must be “192.168.1.x”, where “x” must be a number ranging between 1 and 254, other than 100.

Technical support operators can also communicate with the VMU-C EM through the same LAN port, using the address 192.168.253.254 (this address is fixed and cannot be changed).

If using a mini-USB cable to connect the devices, use the address 192.168.254.254.

If your network setting is different (the first 3 number are not the prescribed ones) you need to temporarily modify your network setting as specified above; then, as described below, after accessing the software you can modify the VMU-C EM network parameters, to ensure that it is compatible with your network, and finally restore your original network setting.

After configuring your IP address, open an Internet browser and type the following address:

<http://192.168.1.110>

VMU-C

The system will display the following access page:

Registered user

Username

Password

Sign In

FREE ACCESS

VMU-C EM

VMUC-EM DATA PUSH - PONTE NELLE ALPI - ENERGY METERS

Fig.– System access page

Clicking the “SIGN-IN” button will access the Login page.

The following are the default username and password:

Username	Password	Name	Level
admin	admin	admin	administrator

To prevent any undesired access to the system, we recommend that you change the default password, particularly if you use Internet connectivity.

2.3 HOME PAGE

The figure below shows the VMU-C EM home page:

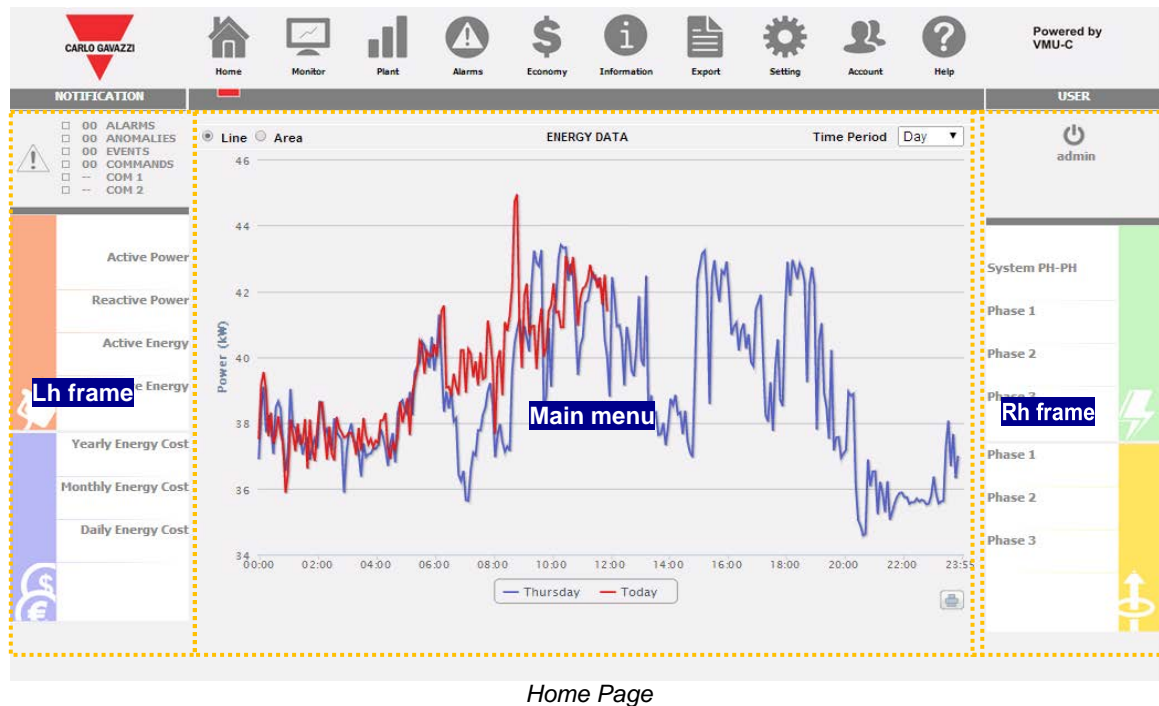

In particular, we have highlighted the following items, which are always available while using the software:

- a) **Main Menu:** it includes the "Navigation Menu"
- b) **Lh frame:** starting from the top:
 - Plant status. - The system reports the overall status and a synoptic showing the alert status for each category (alarms, anomalies, events, commands) and the relevant counters. The COM ports status is also displayed .

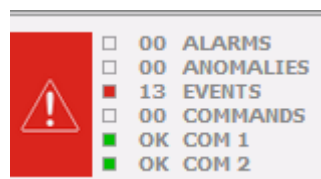

Alerts section

- Production data (automatic data update).

Active Power	43.70 kW
Reactive Power	-53.47 kvar
Active Energy	131495.52 kWh
Reactive Energy	0.74 kvarh

- 1) Instantaneous AC Power (active and reactive)– Instant power (kW,kvar) measured by the energy meter. The piece of data comes from the reference Energy meter (real or virtual), depending on the settings included in the “Energy Meters Configuration”.
- 2) Total AC Energy – Total Energy (active and reactive)measured by the energy meter. The piece of data comes from the reference Energy meter (real or virtual), depending on the settings included in the “Energy Meters Configuration”.

- Costs section.

Yearly Energy Cost	176327.03 €
Monthly Energy Cost	28065.09 €
Daily Energy Cost	557.07 €

Energy costs, calculated at yearly, monthly and daily level, starting from the energy consumption measured by the main meter and the tariff profiled set-up in the relevant configuration section

Rh frame: from the top:

- Log-off button Click the button to log off of the VMU-C EM and return to the access page.
- Username
- PC's date and time.
- Values of the voltages for the main meter (green frame). In this frame data are continuously updated.

System PH-PH	0.00 V
Phase 1	0.00 V
Phase 2	0.00 V
Phase 3	0.00 V

Value of the line voltages for the system and for the star voltages (phase1n, phase2n and phase3n). These values concern the reference instrument (real or virtual). If the reference instrument is virtual, each voltage value shown to the side is calculated as the average of all the relevant voltages of the real instruments set as contributors.

Example:

LLsys Voltage = $[VLLsys(st1)+VLLsys(st2)+VLLsys(st3)+VLLsys(st...)]/n$

L1N Voltage = $[VL1N(st1)+VL1N(st2)+VL1N(st3)+VL1N(st...)]/n$

L2N Voltage = $[VL2N(st1)+VL2N(st2)+VL2N(st3)+VL2N(st...)]/n$

L3N Voltage = $[VLN3(st1)+VLN3(st2)+VLN3(st3)+VLN3(st...)]/n$

Where **LLsys**, **L1N**, **L2N** and **L3N Voltage** represent the values displayed in the green frame. **L1N(st1)** represents the phase1-neutral voltage of instrument 1, **L2N(st2)** the phase2-neutral voltage of instrument 2, **L3N(st3)** represents the phase3-neutral voltage of instrument 3 and so on ... "n" represents the amount of instruments set as "contribution".

- Values of the star voltages for the reference instrument (lower orange frame). In this frame data are continuously updated.

Phase 1	33.58 A
Phase 2	33.58 A
Phase 3	19.94 A

Current value for each phase. These values concern the reference instrument (real or virtual).

- c) **Main Menu:** this area displays the selected variables in graphic form. The type of chart/displayed variables can change according to the selected icon (see navigation menu) and to the variable the user wishes to display. In the bottom section, besides, there is a frame displaying some information about the plant (name, location, ...).

2.3.1 NAVIGATION MENU

Hover your mouse over the different icons to display the relevant meaning in text form. Click on the icon to access the relevant section which will be displayed in the Main Frame.

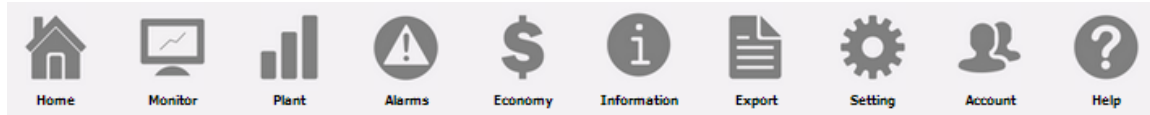

Home

It allows to return to the main page.

Monitor

It allows to display in graphic form the main reference instrument data, like currents, voltages (VLL and VLN), power (kW and kvar), power factor (PF) and, if available, the analogue variables (°C and/or mA and/or mV).

Plant

It allows to display in graphical form all the acquired system data.

Alarms

It allows to display the alarms that have been raised in the plant.

Economy

It allows to display in graphic form the economic countervalues from consumption monitoring.

Information

A tab displaying the plant characteristics.

Export

It allows to stored data to xls format.

Setting (Only available for Administrator users)

It allows to access the system configuration menu.

Account (Only available for Administrator users)

It allows to access the Account management question.

Help

It opens the online Help remotely hosted on Carlo Gavazzi's servers

3 SETTINGS

Click on the “Configuration” icon in the Navigation Menu (Fig. 6) to access the whole system Configuration section.



Three main configuration menus (*SYSTEM*, *PLANT* and *OTHER VARIABLES*) will be displayed on the screen:

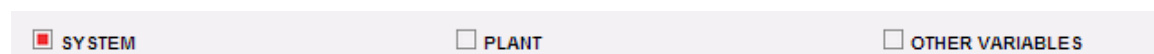

3.1 SYSTEM CONFIGURATION

Clicking on the “SYSTEM” menu will display the following sub-menus:

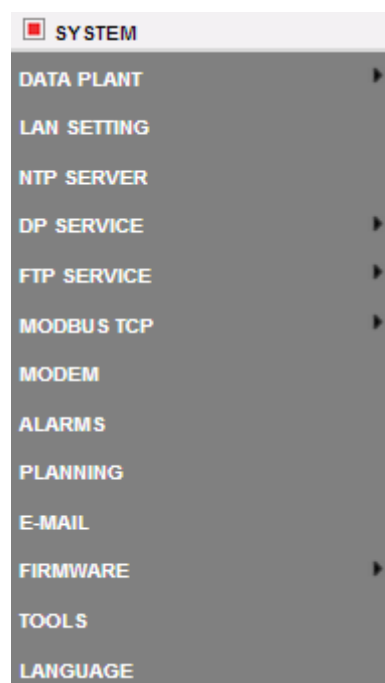

3.1.1 PLANT DATA SETTING

Accessing the “PLANT DATA” menu will open the plant description page.

3.1.1.1 DESCRIPTION SETTING

Clicking on the “DESCRIPTION” menu will display the main page providing a plant description:

PLANT DESCRIPTION

“A”

Plant Name	<input type="text" value="VMUC-EM DATA PUSH"/>
Plant Location	<input type="text" value="Ponte Nelle Alpi"/>
Plant Property	<input type="text" value="Carlo Gavazzi"/>
Installer	<input type="text" value="Carlo Gavazzi"/>
VMU-C Installation Date	<input type="text" value="2014-02-04"/> yyyy-mm-dd
Currency	<input type="text" value="€"/>

CONTRACT HIGHLIGHTS

“B”

	Fixed Monthly Costs	kWh Unit Cost	kvarh Unit Cost	Wmax Monthly Cost	Max Contractual Peak
Tariff 1	<input type="text" value="200.0"/> €	<input type="text" value="1.5"/> €	<input type="text" value="0.5"/> €	<input type="text" value="3.0"/> €	<input type="text" value="100.0"/> kW
Tariff 2	<input type="text" value="150.0"/> €	<input type="text" value="0.75"/> €	<input type="text" value="0.5"/> €	<input type="text" value="3.0"/> €	<input type="text" value="100.0"/> kW

TARIFF CALENDAR CONFIGURATION

“C”

Tariff T Interval	Working Day	T1 Start 1	T1 End 1		T1 Start 2	T1 End 2
		<input type="text" value="08"/> ▾	<input type="text" value="12"/> ▾	--	<input type="text" value="13"/> ▾	<input type="text" value="18"/> ▾
Holidays	<input type="checkbox"/> Mon <input type="checkbox"/> Tue <input type="checkbox"/> Wen <input type="checkbox"/> Thu <input type="checkbox"/> Fri <input checked="" type="checkbox"/> Sat <input checked="" type="checkbox"/> Sun					

All period outside tariff T1 range, are automatically included in the tariff T2. All holidays are included into tariff T2.

Plant Data Configuration

The “**Plant description**” section (see the hatched area “**A**”) allows to enter the general plant data (name, location, date of installation, ...) to simplify the management of the plant itself. In the “Currency” box the user can specify the reference currency for VMU-C EM (€, £, \$, ...).

The “**Contract highlights**” section (see the hatched area “**B**”) displays economy information, concerning the type of contract signed with the energy provider utility (fixed costs, unit costs, contractual limits, etc.). These data must be edited using the point “.” as decimal mark (should you use the comma“,” edited data will not be saved).

Note: when configuring the economic data (see frame “B”) we recommend that you refer to the contract signed with the relevant utility.

VMU-C

In section “**Tariff Calendar Configuration**” (see the hatched area “C”) the user can define which weekdays shall be considered as **holidays** (by exclusion, non-selected days shall be considered as **working days**).

For working days, besides, the user will be able to define two tariffs (*T1 and T2*) for which the individual kWh cost will be different. Within the working day the user will be able to define two periods to be associated with tariff “T1”.

Note: any rime periods not included in tariff “T1” will be automatically included in tariff T2. For holidays, the T2 tariff shall always be used.

Press “Save setting” to store the data into VMU-C EM.

VMU-C

3.1.2 LAN SETTING

Clicking on “LAN SETTING” will grant access to the page shown below.

The screenshot shows the "NETWORK SETTING" interface for a VMU-C device. At the top, the "VMU-C Name" is set to "VMU-C 0 1" (Example: VMU-C01). The interface is divided into four red-dotted areas:

- "A" area:** Contains the radio button "Get an IP address Automatically (DHCP)".
- "B" area:** Contains the "Use the following IP Address:" section with fields for IP Address (192.168.3.221), Subnet Mask (255.255.255.0), and Default Gateway (192.168.3.18).
- "C" area:** Contains the "Use the following DNS server addresses:" section with fields for Preferred DNS server (192.168.3.2) and Alternative DNS server.
- "D" area:** Contains the "DYNAMIC IP ADDRESS MANAGEMENT" section with a checkbox for "Enable Dynamic DNS", a dropdown for "Server Dynamic DNS" (DynDns.org), and fields for Hostname, Username, and Password.

A "Save Setting" button is located between the "C" and "D" areas.

Network settings

g

This page consists of three sections:

1) Network setting

To configure the LAN port, you can choose between two options:

- **Get an IP address automatically (DHCP)** (see “A” area) : the address is automatically acquired when switching on the VMU-C EM from a DHCP server, which must exist inside the network the device is connected to. The IP address will be dynamic and not known in advance. In this case you can reach VMU-C from within the same network by typing on the browser the Machine Name assigned to it (e.g. VMU-C01).
- **Use the following IP address (Static routing)** (see “B” area): you need to manually specify an IP address along with a network mask and a default gateway.

In the absence of a network administrator who can provide the correct network parameters, assign an address belonging to the same class as those of the other devices existing on the same network, and indicate “255.255.255.0” as the network mask.

The default gateway is only mandatory if you plan to access VMU-C EM through the Internet using the LAN connection; in this case, indicate in this field the IP address of the ADSL router.

- Finally, you can manually specify the addresses of the preferred and alternative DNS servers to be used to access the Internet by selecting (**Use the following DNS server addresses**) (see “C” area); as an alternative, if the LAN port is set to DHCP mode, you can allow VMU-C EM to acquire the DNS server address from the DHCP server, by enabling the option (**Get DNS server address Automatically**).

Press the “**Save setting**” button to store the network setting. To apply the new settings, VMU-C needs a restart, which is performed automatically; wait until the count-down is over; then you'll be routed back to the home page.

The system requires to have access to the Internet for the following services:

- To send e-mails to the configured SMTP server.
- To synchronise the date and time settings through the NTP service (if configured).

Note: to ensure that VMU-C EM is accessible from the outside through a LAN connection, it needs to be appropriately re-routed to the ADSL Modem or Router (NAT- Port forwarding) to which it is connected. **The ports to be re-routed are: 80 and 52325.**

2) Dynamic public IP address management

Should you not have at your disposal a static public IP address allowing to reach the VMU-C from the Internet, but should you have to use any public IP addresses dynamically assigned by your ISP (Internet Service Provider), you may resort to DNS server managers keeping the dynamic public IP address constantly synchronised with a domain name (see “D” area). The managers with which VMU-C EM is compliant are *DynDns.org*, *DynDns.it* and *No-ip.com*. To access the service you need to connect to <http://www.dyndns.org/> (or <http://www.dyndns.it/> or <http://www.No-ip.com/>), register by creating an account and finally create a new “Dynamic DNS host”. The term “Dynamic DNS host” indicates a domain address which shall then be typed into the browser's address bar to reach VMU-C. (E.g. VMUC.No-ip.com). When registering to DynDNS.org (or to an equivalent site), please provide a Username and a Password that VMU-C will use to authenticate with the server.

To enable the management of the dynamic public IP address you need to:

- Check “Enable dynamic DNS”.
- Type the name of the chosen Dynamic DNS host.
- Type the Username and Password provided during account registration.
- Click on “Save setting”

Note: Carlo Gavazzi has no commercial or technical agreement with any Dynamic DNS service provider; the above compliancy is meant as a tool to allow customer to use some of the major dynamic DNS infrastructure available in the market

DYNAMIC IP ADDRESS MANAGEMENT	
<input type="checkbox"/> Enable Dynamic DNS	Server Dynamic DNS <input type="text" value="DynDns.org"/>
	Hostname <input type="text"/>
	Username <input type="text"/>
	Password <input type="text"/>
<input type="button" value="Save Setting"/>	

Dynamic public IP address management

The service will be available after about 6 minutes.

Note: Resorting to this service is often necessary when the Internet connection is established through a GPRS/UMTS modem or when you don't have any static IP address on your ADSL line. Mobile providers typically don't provide a static IP address.

3.1.3 NTP SERVER SETTING

Clicking on "NTP SERVER" will grant access to the page shown below:

CLOCK SYNCHRONISATION	
Enabling Network Clock Synchronisation <input checked="" type="checkbox"/>	
NTP Server 1 :	<input type="text" value="ntp1.inrim.it"/>
NTP Server 2 :	<input type="text" value="ntp2.inrim.it"/>
<input type="button" value="Save Setting"/>	

NTP Server setting

You can set up to two NTP servers. Enabling this server type allows to constantly synchronise the DATE and TIME data-

VMU-C

3.1.4 DP SERVICE SETTING

The DP service is the highly secure and efficient protocol that VMU-C uses to exchange information with Eos-Server and VMU-Y.

The protocol is based on a Web-Service oriented architecture based on HTTP.

Please check Em²-Server and VMU-Y documentation for information about those systems.

Both Em²-Server and VMU-Y allow users to build distributed systems where VMU-C EM is a gateway in a charge of gathering data from the plant and route information to a centralized database (Em²-Server /VMU-Y)

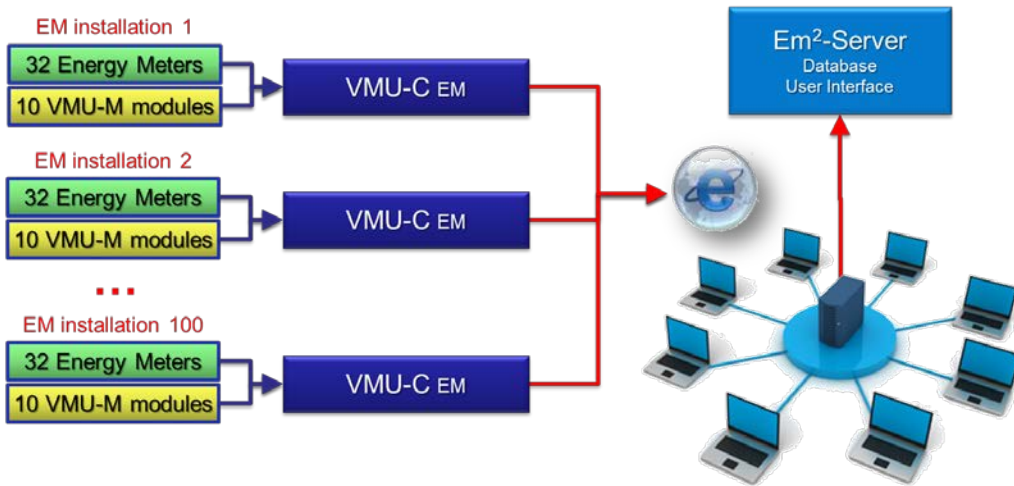

Em²-Server architecture



DP Service Menu

3.1.4.1 DP SERVICE SETTINGS

By selecting the Setting submenu it is possible to access the DP Service configuration page.

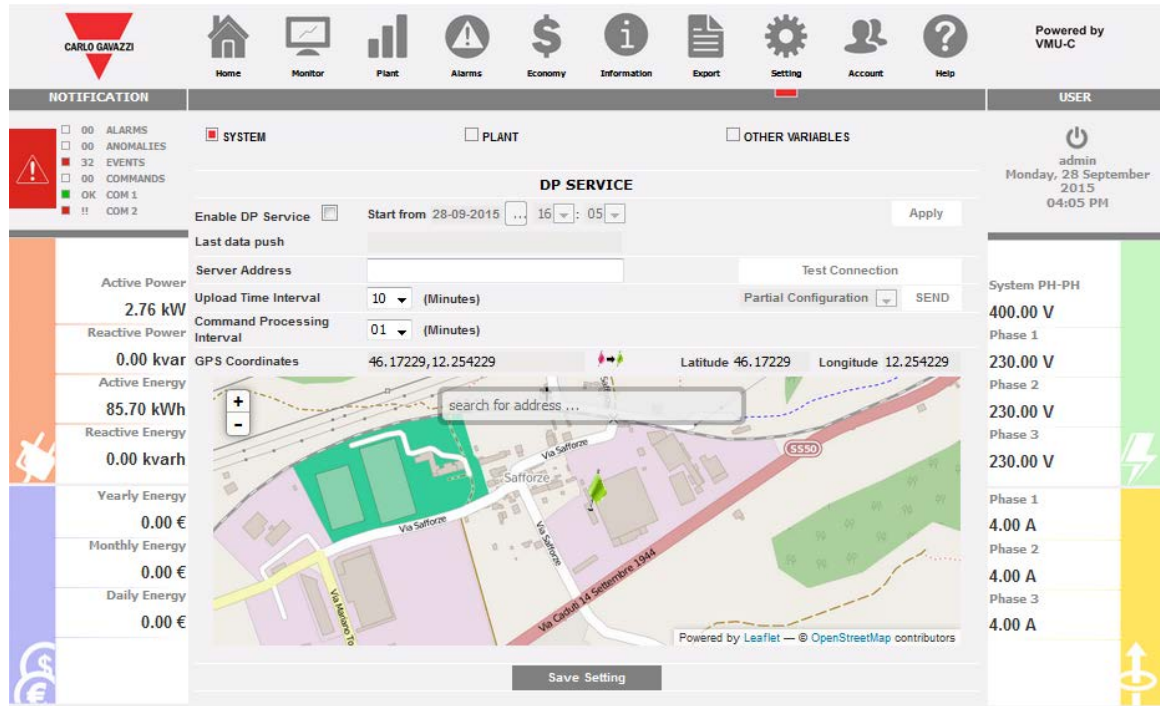

DP Service configuration

The parameters to set to successfully join the Em²-Server /VMU-Y are:

Parameter	Description
Server Address	It is the internet address of the Em ² -Server / VMU-Y
GPS coordinates	The GPS coordinates of the VMU-C; they may be set manually or by using the Map on the bottom
Upload time interval	It is the time interval between two distinct data upload transactions from VMU-C to Em ² -Server /VMU-Y It depends on available bandwidth (on both sides), amount of data to push, Internet congestion. Typically "10 minutes" is a good compromise
Command Processing interval	It is the time interval between two distinct request-for-commands transactions from VMU-C to Em ² -Server /VMU-Y; VMU-C asks Em ² -Server / VMU-Y for commands at scheduled intervals and processes them accordingly. Typically it is equal to "Upload time interval"
Start from	It is the timestamped date by which the data push synchronization to the server starts. This means that samples with timestamp less than this parameter will not be pushed to the database of the server. The default date is TODAY. The user can specify a different date (from the past) if there is the need to synchronize historical data. This date can be changed only at the data push start-up or while changing the target server (new start-up).

The available commands are:

Command	Description
Test Connection	It allows to check if the configured parameters are good, and it is possible to establish a connection between VMU-C and Em ² -Server /VMU-Y
Send	It allows to send from VMU-C to Em ² -Server /VMU-Y: <ul style="list-style-type: none"> • Full configuration (after having finalized the VMU-C's configuration) • Partial configuration (after having updated the VMU-C's configuration) • Command request (to force VMU-C to check if there are any pending commands on Em²-Server /VMU-Y)
Save setting	To save the configuration
Apply	The relevant start-up date is set as a starting point for the data push; IMPORTANT NOTE: THIS FEATURE MUST BE USED ONLY WHILE CONNECTING TO A SERVER FOR THE FIRST TIME OR WHILE SWITCHING THE DATA PUSH CONNECTION TO A NEW SERVER, OTHERWISE THERE IS THE RISK OF DATA CORRUPTION AT THE SERVER SIDE.

Notes:

- 1) *It is always advisable to fully finalize the VMU-C configuration before sending it to Eos-Server*
- 2) *VMU-C can successfully join Em²-Server only if the necessary license plan has been installed in the target server*

3.1.4.2 DP SERVICE LOGS

Two sets of Logs are available within the data push section:

- Logs of transactions successfully completed
- Logs of transaction with errors

In both cases, up to 500 records are stored.

LOGS ERROR				
1	Data	2014-02-17 15:19:25	2014-02-17 15:19:25	Base64 decoding error
2	Data	2014-02-13 10:03:26	2014-02-13 10:03:27	Base64 decoding error
3	Data	2014-02-12 09:48:15	2014-02-12 09:48:16	Base64 decoding error
4	Data	2014-02-07 11:19:04	2014-02-07 11:19:04	Base64 decoding error
5	Data	2014-02-03 14:47:35	2014-02-03 14:47:36	Base64 decoding error
6	Data	2014-01-31 15:07:53	2014-01-31 15:07:54	Operation not permitted for an unlicensed device
7	Data	2014-01-31 15:07:24	2014-01-31 15:07:25	Operation not permitted for an unlicensed device
8	Data	2014-01-31 15:06:55	2014-01-31 15:06:56	Operation not permitted for an unlicensed device
9	Data	2014-01-31 15:06:27	2014-01-31 15:06:27	Operation not permitted for an unlicensed device
10	Data	2014-01-31 14:55:44	2014-01-31 14:55:45	Operation not permitted for an unlicensed device
11	Data	2014-01-31 14:55:15	2014-01-31 14:55:16	Operation not permitted for an unlicensed device
12	Data	2014-01-31 14:54:44	2014-01-31 14:54:44	Operation not permitted for an unlicensed device
13	Data	2014-01-31	2014-01-31	Operation not permitted for an unlicensed device

Data push logs

3.1.5 FTP SERVICE CONFIGURATION

By clicking on “FTP SERVICE” the following 3 sub-menu are presented:



3.1.5.1 AVAILABLE COMMUNICATION PROTOCOLS

Two different protocols are available in the FTP section:

- a) FTP – Push: it works by uploading files to a remote server upon a preconfigured schedule
- b) SFTP – push: : it works by uploading files to a remote server upon a preconfigured schedule, using the SFTP secure encrypted protocol
- c) HTTP – Pull: by means of an HTTP API (application program interface) it is possible for a remote client to poll data from the VMU-C on request

S/FTP and HTTP - pull protocols can be used together paying care not to exceed with HTTP-Pull requests (by sending too many requests at the same time it is possible to exceed the capacity of VMU-C thus causing overload).

3.1.5.2 FTP, SFTP SERVICE SETTINGS

By clicking on “SETTING” it is possible to configure the parameters needed to enable data communication from VMU-C to the customer’s FTP or SFTP server:

FTP SERVICE

Enable FTP Service

Push Protocol FTP

Server Address pipptest.it

Remote Directory

Server User xxxx

Server Password ●●●●●●●● 👁

Data Type Alarms Measurements

Meter and Record selection 🔧

Upload Time Interval 00 - 10 (hh:mm)

First Delivery (Date / Time) 28 - 09 - 2016 08 : 00 : 00

(HTTP Pull) Client User admin

(HTTP Pull) Client Password ●●●● 👁

Test Connection
Save Setting

FTP Service

The relevant fields must be completed according to the following guideline:

- “Enable FTP Service”: to be checked to enable data communication (both by FTP-push and HTTP-pull); both HTTP-pull and FTP-push are available at the same time.
- “Push protocol”: it allows to choose between FTP and SFTP
- “Authentication method” (SFTP only): it allows to choose between two authentication methods:
 - User/password
 - User/pre-shared key: a security key is generated with the relevant icons on the right; the key can be saved and then shared with the SFTP server’s administrator

In the case FTP communication is needed, the following fields must be completed:

- “Server Address”: it is the Internet address of the FTP server to which VMU-C will upload data
- “Remote directory”: the remote FTP server’s directory to which data will be uploaded
- “Server user”: the user name authorized to access the remote FTP server’s directory
- “Server password”: the password to be used together with the “Server user” to access the remote directory
- “Data type”: it allows to push either alarms or measurements or both
- “Meter and Record selection”: it allows to filter the range of variables to be delivered to the server
- “Upload time interval” (hh:mm) : the interval time between two successive FTP upload actions (in the range 10 minutes – 24 hours)
- “First Delivery” (date/time): date and time of the first upload action to the FTP server

In the case it is needed to exchange data using HTTP-pull, the VMU-C will send its response to an HTTP query sent by the remote system (automated HTTP client); for security reasons an authentication is needed to poll data, and the following fields must be completed prior to be able to perform HTTP requests:

- “Client User”: user name to authenticate on VMU-C while executing a query
- “Client Password”: password to authenticate on VMU-C while executing a query

Press “Save Configuration” to confirm configuration changes.

After having completed the relevant fields for FTP communication it is suggested to push “Test connection” so as to check that everything is working correctly

3.1.5.3 FTP SERVICE LOGS

By clicking on the “LOGs OK” item, the following screenshot will appear, reporting all the FTP transactions completed correctly

LOGS OK				
	DATE / TIME	IP ADDRESS	FILE	DETAILS
1	2014-03-24 17:55:07	88.32.230.187	VMU-C_BL3080002001U_ AR_2014-03-24-17-55-07_S.csv	
2	2014-03-24 17:45:07	88.32.230.187	VMU-C_BL3080002001U_ AR_2014-03-24-17-45-07_S.csv	
3	2014-03-24 17:35:07	88.32.230.187	VMU-C_BL3080002001U_ AR_2014-03-24-17-35-07_S.csv	
4	2014-03-24 17:25:07	88.32.230.187	VMU-C_BL3080002001U_ AR_2014-03-24-17-25-07_S.csv	
5	2014-03-24 17:15:07	88.32.230.187	VMU-C_BL3080002001U_ AR_2014-03-24-17-15-07_S.csv	
6	2014-03-24 17:05:07	88.32.230.187	VMU-C_BL3080002001U_ AR_2014-03-24-17-05-07_S.csv	
7	2014-03-24 16:55:07	88.32.230.187	VMU-C_BL3080002001U_ AR_2014-03-24-16-55-07_S.csv	
8	2014-03-24 16:45:07	88.32.230.187	VMU-C_BL3080002001U_ AR_2014-03-24-16-45-07_S.csv	
9	2014-03-24 16:35:07	88.32.230.187	VMU-C_BL3080002001U_ AR_2014-03-24-16-35-07_S.csv	
10	2014-03-24 16:25:07	88.32.230.187	VMU-C_BL3080002001U_ AR_2014-03-24-16-25-07_S.csv	
11	2014-03-24 16:15:07	88.32.230.187	VMU-C_BL3080002001U_ AR_2014-03-24-16-15-07_S.csv	
12	2014-03-24 16:05:08	88.32.230.187	VMU-C_BL3080002001U_ AR_2014-03-24-16-05-08_S.csv	

The same is valid on the LOGS ERROR menu.

3.1.6 MODBUS TCP SLAVE

Clicking on “MODBUS TCP” will display a sub-menu, “SLAVE”, which allows setting the MODBUS TCP communication through the Ethernet port.

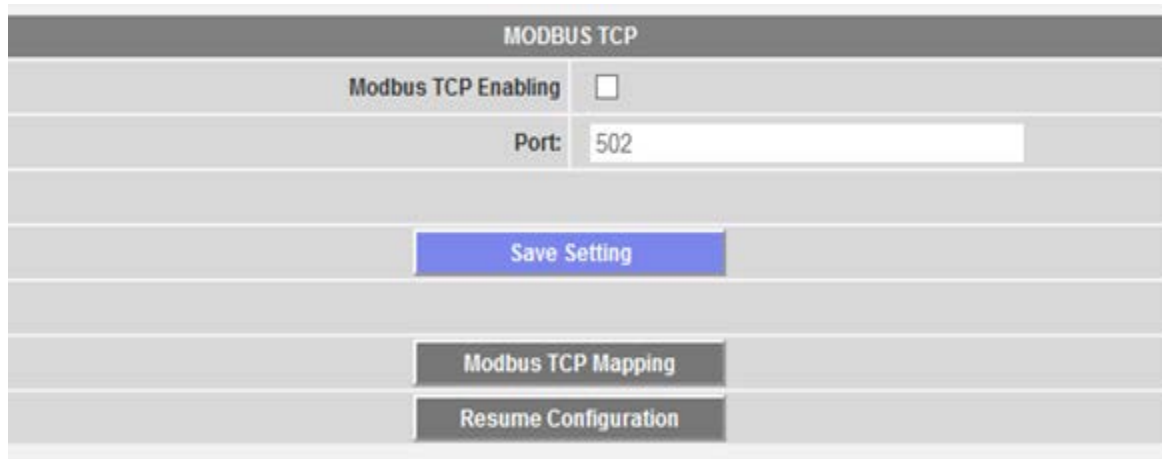

Fill in the fields according to the following specifications:

- “*Modbus TCP Enabling*”: check the relevant box to enable this function.
- “*Port*”: set the relevant Ethernet port. 502 is the standard for Modbus TCP.

Press “Save setting” key to store enabling and port settings.

Press “Modbus TCP Mapping” key to enter the Modbus TCP configuration page, where the runtime configuration (the last saved configuration) is shown.

In case some modifications are carried out to the configuration but not saved, next time the “Modbus TCP mapping” page is accessed, by pressing the “Resume Configuration” key, you can proceed with the interrupted modification process.

3.1.6.1 Modbus TCP Mapping

In the “Modbus TCP Mapping” page all the energy meters installed on the Modbus RTU bus (as defined in the Plant Configuration Wizard) are listed, ordered by serial address. Their tag name are shown in the Description field. The table also shows the relevant Modbus TCP address, whenever correctly assigned (green LED). A red LED shows if the relevant configuration is not correct (i.e. the selected TCP address is already used).

A yellow LED shows if the instrument is disabled in the Modbus TCP mapping.

The list includes the VMU-C itself: if equipped with analogue/temperature input modules, these variables can be retransmitted by Modbus TCP.

Modbus TCP Mapping				
		Back	Create Map	Reset Map
			Export PDF Map	Export XML Map
Modbus RTU	Modbus TCP	Description		
1	●	1	Offices_(commercial_area)	Setup
2	●	---	Cabinet_MG.2	Setup
3	●	3	Cabinet_MG.1	Setup
4	●	---	Production_department	Setup
5	●	---	Power_supply_BUS-BAR_1	Setup

Press the “Create map” key to save the modifications and create the Modbus TCP map in VMU-C.

Press the “Export PDF map” or “Export XML map” to create the map in PDF format or as an XML files to be exported to implement the Modbus TCP map in the relevant master.

Press the “Reset TCP map” to reset and regenerate all the maps: in the latter case all the variables added in a second time will be re-aligned with the other ones.

3.1.6.2 Modbus TCP Configuration

Press the “Setup” key close to the meter description to set its Modbus TCP parameters by means of the following page.

Energy Meter - Modbus TPC Configuration	
Back	Save
Description:	Offices_(commercial_area)
Enable Modbus TPC Mapping	<input checked="" type="checkbox"/>
Modbus TCP Address	1
Variables Available	Selection Filters
<input checked="" type="checkbox"/> AL1 <input checked="" type="checkbox"/> AL2 <input checked="" type="checkbox"/> AL3 <input checked="" type="checkbox"/> Hz <input checked="" type="checkbox"/> PF L1 <input checked="" type="checkbox"/> PF L2 <input checked="" type="checkbox"/> PF L3 <input checked="" type="checkbox"/> PF sys <input type="checkbox"/> Phase sequence <input type="checkbox"/> VL12 <input type="checkbox"/> VL1M	Reactive Power <input type="button" value="Filter"/> <input type="button" value="All"/> <input type="button" value="None"/>

Fill in the fields according to the following specifications:

VMU-C

- “*Enable Modbus TCP Mapping*”: check the relevant box to enable the selected meter in the Modbus TCP map.
- “*Modbus TCP address*”: set the relevant Modbus TCP address (1 to 247)
- “*Variables Available*”: check the variables that must be retransmitted among the list of all the available ones.

A set of keys allow to help in the variable selection: “All” key to select all the available variables, “None” key to unselect all the variables, “Filter” key to enable/disable (toggle button) the variables described in the above combo box. In the example picture above, pressing “Filter” will enable/disable all the Reactive Power variables (system and single phase var).

In case a variable is deleted or added in a second time, please refer to next paragraph.

Press “Save” key to store the modifications, “Back” to go back to the previous page without saving.

3.1.6.3 Notes about Modbus TCP Mapping in VMU-C EM

The data format is IEEE754 (even if differently managed by the meter, e.g. INT 32) for all the instantaneous variables; it is INT64 with 0,1 kWh (or m3) resolution for all the meters or utility counters.

The web server and the Modbus TCP slave communication work at the same time over the Ethernet port of VMU-C EM.

When the Modbus TCP map is created, the variable are listed following a predefined order.

In case a variable is deleted in a second time, the relevant Modbus memory address will be left empty. In this case the floating point value FFFF FFFFh (meaning “NaN”, “not a number”) or the UINT64 value FFFF FFFF FFFF FFFFh can be read in this memory address.

In case a variable is added in a second time, the relevant Modbus memory address will be automatically assigned after the existing ones.

If variables are added and removed so many times to fill all the available addresses in the map, a message will appear asking to reset and regenerate all the maps with the relevant command (see above).

3.1.7 MODBUS TCP MASTER

The MODBUS TCP MASTER function allow VMU-C to gather data from meters connected via Ethernet, through the MODBUS/TCP protocol. By accessing the relevant item in the SYSTEM sub-menu (see picture), the configuration menu is displayed allowing to configure the necessary parameters.

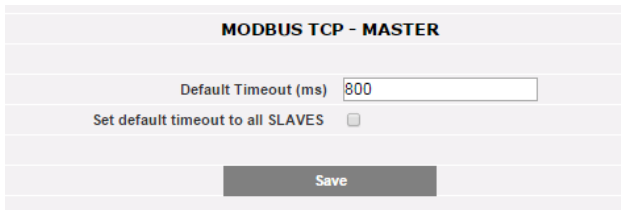
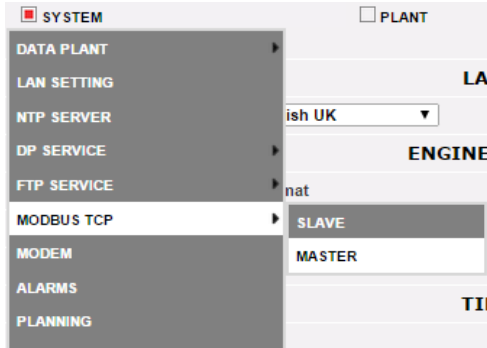

The configuration of Meters connected by Ethernet requires user to define:

- IP address of the meter
- Modbus/TCP port (default = 502)
- Meter's SLAVE MODBUS address (only in the case of a meter connected by RS485 through a MODBUS/RTU to MODBUS/TCP converter; Carlo Gavazzi's meters with embedded Ethernet port do not need any SLAVE address configuration)

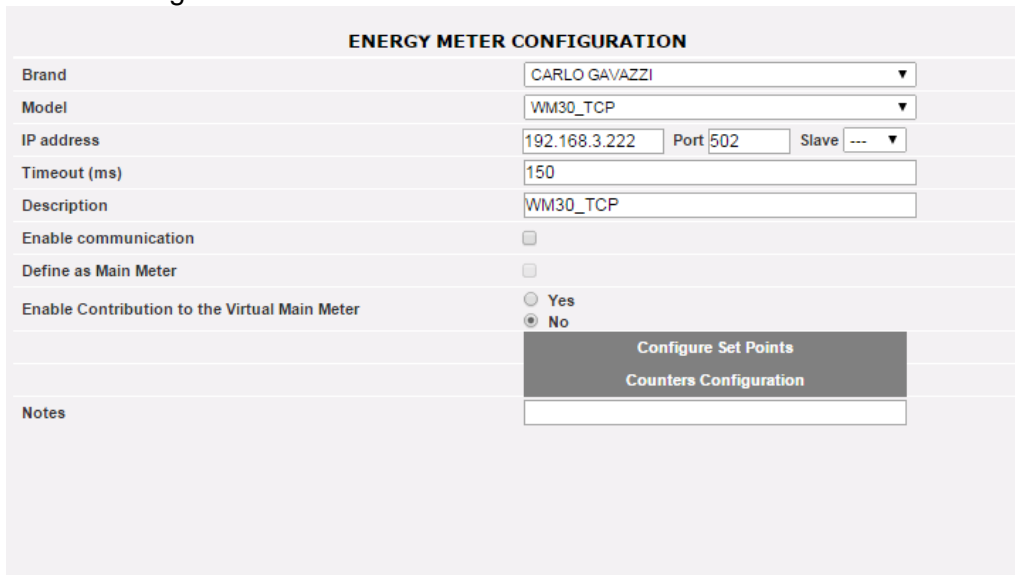

3.1.8 THE VMU-W MODEM

3.1.8.1 INSTALLING AND CONFIGURING THE VMU-W MODEM

Connecting the VMU-W module

To connect the Modem (VMU-W) to VMU-C you will have to perform the following steps:

- Make sure the VMU-C and the VMU-W are not powered.
- Connect the VMU-W to the VMU-C through the auxiliary bus on the left side of the VMU-C.
- Make sure the **SIM is not protected by a PIN code** (should that be the case, disable the protection).
- Insert the SIM into the VMU-W modem through the special slot.
- Connect the antenna and put it in a place assuring proper signal reception.
- Restore the power supply of both devices (VMU-C and VMU-W).
- Make sure that both devices are located in a dry place, protected against rain and dust.

On the front side of VMU-W there are two LEDs, whose meaning is the following:

- 1) Green LED: Steadily on => the equipment is powered.
- 2) Blue LED: Off => no power supply. Fast blinking => searching for the cover signal / not registered / switching off. Slow blinking => Service is registered and signal is available. Steadily on => communication under way.



VMU-W modem

By clicking on “MODEM” it is possible to access the configuration of the parameters which allow VMU-W based communication. It is needed to complete all the fields from the following form:

MODEM CONNECTION STATUS			
Signal		Model	---
Network Registration	---	Data Connection	---
IP address		---	
MODEM CONFIGURATION			
<input type="checkbox"/> Modem Enabling	<input type="checkbox"/> Internet Connection Enabling	<input type="checkbox"/> SMS Enabling	
MODEM SETTING FOR INTERNET CONNECTION			
Provider	▼		
SMS Commands			
Password:	<input type="password" value="****"/>	[0..9]	
Confirm Password:	<input type="password" value="****"/>	[0..9]	
MODEM WATCHDOG			
<input type="checkbox"/> Enable Ping Reboot	Website/IP Address: <input type="text"/>		
<input type="checkbox"/> Enable Scheduled Reboot	Intervall Time (Hours):		01 ▼
Save Setting			

Modem configuration

The web page includes 5 areas:

- a) MODEM CONNECTION STATUS
 - Signal = Modem’s signal level (RX)
 - Model = full Modem’s part number
 - Network registration = Mobile network to which the modem is connected
 - Data connection = connection status
 - IP address = IP address assigned to the device by the mobile network
- b) MODEM CONFIGURATION
 - Modem Enabling = to be checked to enable the VMU-W modem
 - Internet Connection Enabling= to be checked to enable data communication over Internet
 - SMS Enabling= to be checked to enable SMS alarm dispatching
- c) MODEM SETTING FOR INTERNET CONNECTION
 - Provider = APN provider for data connection
- d) SMS COMMANDS
 - Password = numeric password to be set to allow user to send SMS commands to the VMU-W (see the relevant section below)
 - Confirm password = field used to confirm the password above
- e) MODEM WATCHDOG
 - See section below

3.1.8.2 MODEM WATCHDOG

MODEM WATCHDOG	
<input type="checkbox"/> Enable Ping Reboot	Website/IP Address: <input type="text"/>
<input type="checkbox"/> Enable Scheduled Reboot	Intervall Time (Hours): 01 ▼
Save Setting	

Modem Watchdog

It is possible to overcome common issues in mobile communication by means of 3 different mechanisms:

- 1) Ping Reboot: if enabled, VMU-C + VMU-W sends a PING to the defined IP address (to be chosen as a reliable always ON server on Internet). In the case of repeated lost answer from the PING, the system reboots
- 2) Scheduled reboot: the system reboots each interval time (chosen in the relevant parameter field)
- 3) SMS command: see next section

3.1.8.3 SMS COMMANDS

SMS Commands	
Password:	<input style="width: 150px;" type="password" value="****"/> [0..9]
Confirm Password:	<input style="width: 150px;" type="password" value="****"/> [0..9]

SMS COMMANDS SETTINGS

The following command are available by sending SMS to the VMU-W's SIM number:

Command	Syntax	Notes
VMU-C Reboot	REBOOT PASSWORD (e.g. REBOOT 1234)	Password defined by the user in the relevant section in the page above; the system sends an acknowledge to the calling phone (REBOOT OK)
Data communication ON	DATA MODEM ON PASSWORD (e.g. DATA MODEM ON 1234)	Password defined by the user in the relevant section in the page above; the system sends an acknowledge to the calling phone (DATA MODEM ON OK)
Data communication OFF	DATA MODEM OFF PASSWORD (e.g. DATA MODEM OFF 1234)	Password defined by the user in the relevant section in the page above; the system sends an acknowledge to the calling phone (DATA MODEM OFF OK)
Public IP inquiry	IP PASSWORD (e.g. IP 1234)	Password defined by the user in the relevant section in the page above; the system sends the IP address by SMS to the calling phone

3.1.9 ALARM SENDING CONFIGURATION

Clicking on “ALARMS” will grant access to the page shown below.

The image shows two identical configuration screens for 'Configuring Alarming'. The top screen is for 'Group 1' and the bottom for 'Group 2'. Both screens have the following fields:

- Recipients Addresses:** Text input containing 'alessandro.fardin@gavazziacbu.it;ermes.cellot@gavazziacbu.it;marco.meneghel@gavazziacbu.it'.
- Object:** Text input containing 'VMU-C 115 Alarm Group1' (for Group 1) and 'VMU-C 115 Alarm Group2' (for Group 2).
- Action:** Radio buttons for 'Send Mail' (checked) and 'Send SMS'. A 'Phone Number' text input is next to 'Send SMS'. 'Test Mail' and 'Test SMS' buttons are on the right.
- Send for:** Four buttons: 'Alarms' (checked, red), 'Anomalies' (checked, yellow), 'Events' (unchecked, blue), and 'Commands' (unchecked, grey).

A 'Save Setting' button is located at the bottom of the Group 2 screen.

Outgoing mail configuration

VMU-C can send alert emails and/or SMS to more recipients at the same time and according to predefined rules. This page contains two separate configuration screens, in order to create two separate users groups to send communications to. In “Send for” selection field, alarm messages can be filtered to be sent to the relevant receivers.

Fill in the fields in both screens according to the following specifications:

Field	Description
Recipients addresses	Email addresses of the alarm messages' recipients <i>Note: Addresses must be separated by semicolon (;) with no space.</i>
Object	Email's Subject
Action	<ul style="list-style-type: none"> Send Mail: to send the alerts by email Send SMS: to send the alerts by SMS (to the phone number on the right)
Phone number	Recipient's phone number including international prefix code
Send for:	<p>It is possible to choose which category of alerts must be delivered to recipients among Alarms, anomalies, events, commands (more information on the alarms section) .</p> <ul style="list-style-type: none"> “Alarms”: High-priority alerts. “Warning”: Low-Medium priority alerts. “Events”: Opening/Closing of digital inputs and outputs

VMU-C

	<ul style="list-style-type: none">• “<i>Commands</i>”: Change of parameters on Eos-Array
--	--

3.1.10 PLANNING CONFIGURATION

Clicking on “PLANNING” will grant access to the page shown in below-

SCHEDULING SENDING DATA VIA MAIL		
Recipients Addresses	alessandro.fardin@gavazziacbu.it;ermes.cellot@gavazziacbu.it;marco.meneghel@gavazziacbu.it	
Action	<input checked="" type="checkbox"/> Send Mail	<input type="button" value="Test Mail"/>
Send Plant Data	<input checked="" type="checkbox"/> Daily	<input checked="" type="checkbox"/> Weekly
	<input checked="" type="checkbox"/> Monthly	<input checked="" type="checkbox"/> Yearly
<input type="button" value="Save Setting"/>		

Email scheduler

- Scheduling sending data via Mail

VMU-C allows scheduling an e-mail sending with a .xls file attached, containing the system production data for the period selected in "Send Plant Data". The e-mail can be sent to more receivers at the same time.

Note: to be able to send any e-mail, the outgoing mail server must be appropriately configured in the system.

Fill in the fields in both screens according to the following specifications:

“**Recipients addresses**”: E-mail addresses of receivers the production data are sent to.

Note: Addresses must be separated by semicolon (;) with no space.

“**Action**”: Enable/disable schedule:

- “**Send Mail**”: Check to enable e-mail sending.

Note: to be able to send any e-mail, the outgoing mail server must be appropriately configured in the system. (See the previous paragraph)

- “**Test Mail**”: Press this key to receive a test e-mail at the email addresses specified in “Recipients addresses” field.

Note: if the e-mail is not received, check outgoing mail server settings, recipient address, VMU-C EM reachability from Internet.

“**Send Plant Data**”: Check email sending period.

- “**Daily**”: every day at 11:59 p.m., a .xls file is sent with daily consumption data. The file will have the following structure for AC and DC data respectively:

AC				
Date 2014-01-22	Total Energy(read from energy meters) (kWh)	Average Power on period(read from energy meters) (kW)	Total Reactive Energy(read from energy meters) (kvarh)	Average Reactive Power on period(read from energy meters) (kvar)
00:00	52499,48	10,19	14724,7	-2,57
00:05	52500,25	9,57	14724,99	-1,79
00:10	52501,05	9,65	14725,26	-2,25
00:15	52501,85	10,04	14725,45	-3,06
00:20	52502,66	10,03	14725,64	-3,18
00:25	52503,47	9,74	14725,87	-2,64

DC				
Date 2014-01-22	Total Energy(read from energy meters) (kWh)	Average Power on period(read from energy meters) (kW)	Average Voltage on period (read from energy meters) (V)	Average Current on period (read from energy meters) (A)
00:00	0,00	0,00	48,12	0,00
00:05	0,00	0,00	48,11	0,00
00:10	0,00	0,00	47,98	0,00
00:15	0,00	0,15	48,06	3,12

“Daily” file format

- **“Weekly”**: an .xls file containing the consumption data of each day of the week that just ended is sent at 11:59 p.m. of each Sunday. The file will have the following structure for the AC data and similar for the DC data:

AC				
Date 2014-02-02	Total Energy(read from energy meters) (kWh)	Average Power on period(read from energy meters) (kW)	Total Reactive Energy(read from energy meters) (kvarh)	Average Reactive Power on period(read from energy meters) (kvar)
00:00	63114,69	10,79	16708,93	-2,12
00:05	63115,55	10,41	16709,23	-1,43
00:10	63116,42	10,49	16709,52	-1,54
00:15	63117,3	10,69	16709,76	-2,11
00:20	63118,2	10,8	16710,01	-2,08
00:25	63119,09	10,79	16710,29	-1,78
00:30	63119,97	10,6	16710,63	-0,96
00:35	63120,86	10,76	16710,9	-1,92
00:40	63121,77	10,96	16711,14	-3,49
00:45	63122,77	11,98	16711,34	-2,59
00:50	63123,7	11,31	16711,53	-2,54
00:55	63124,65	11,01	16711,70	-1,01

“Weekly” file format

- **“Monthly”**: on the last day of the month at 11:59 p.m., a .xls file is sent with detailed consumption data (daily definition) for every day of the month. The file will have the following structure for the AC data and similar for the DC data:

AC				
Date	Total Energy(read from energy meters) (kWh)	Average Power on period(read from energy meters) (kW)	Total Reactive Energy(read from energy meters) (kvarh)	Average Reactive Power on period(read from energy meters) (kvar)
01-01-2014	10381	1,24	870,7	-0,74
02-01-2014	10424,1	1,8	873,3	-0,64
03-01-2014	10453,9	1,24	873,6	-0,73
04-01-2014	10483,7	1,24	874	-0,74
05-01-2014	10513,5	1,24	874,3	-0,74
06-01-2014	10543,4	1,24	874,7	-0,73
07-01-2014	10720,3	7,36	888	-1,7
08-01-2014	10906,2	7,75	902,4	-1,19
09-01-2014	11087,7	7,57	916,9	-1,75
10-01-2014	11271,7	7,66	930,6	-1,74
11-01-2014	11303,5	1,32	931	-0,85

“Monthly” file format

- **“Yearly”**: on December 31st at 11:59 p.m., a .xls file is sent with the consumption data (individual month definition) for every day of the year. The file will have the following structure for the AC data and similar for the DC data:

Date	Energy on period (read from energy meters) (kWh)	Instantaneous Power (read from energy meters) (kW)	Energy on period (read from energy meters) (kvarh)	Instantaneous Power (read from energy meters) (kvar)
gen-12	654,0	27,2	456,0	-13,8
feb-12	406,8	17,0	225,6	-8,2
mar-12	1743,6	72,7	838,8	-22,6
apr-12	1790,4	74,2	824,4	-21,5
mag-12	1810,8	75,5	830,4	-20,2
giu-12	1956,0	81,1	866,4	-19,8
lug-12	1616,4	67,3	700,8	-15,6

“Yearly” file format

3.1.11 E-MAIL (OUTGOING MAIL SERVER) CONFIGURATION

Clicking on the “E-MAIL” item will grant access to the page shown below

CONFIGURING OUTGOING MAIL SERVER	
Sender Address	<input type="text" value="vmuc.ponte@gmail.com"/>
Sender Name	<input type="text" value="VMU-C-PONTE"/>
Server SMTP	<input type="text" value="smtp.gmail.com"/>
Username Server SMTP	<input type="text" value="vmuc.ponte"/>
Password Server SMTP	<input type="password" value="*****"/>
<input type="button" value="Save Setting"/>	

Outgoing mail configuration

The outgoing mail server configuration is necessary to send alarm or history data e-mails from the plant. If configuration is incomplete or incorrect, VMU-C EM cannot send any communications by e-mail.

Fill in the fields according to the following specifications:

- “**Sender address**”: e-mail address associated with VMU-C EM. If the address is invalid, the e-mails sent by VMU-C EM might be considered as SPAM.
- “**Sender name**”: sender name. (From)
- “**Server SMTP**”: Address of SMTP server for outgoing mail.
- “**Username Server SMTP**”: username for access authentication to SMTP server.
- “**Password Server SMTP**”: password for access authentication to SMTP server.

Press “Save setting” key to store settings.

Note: to ensure proper operation of email message sending, refer to “Alarm configuration” paragraph.

Note: should you use a mail server not requiring the configuration of the “UserName” and “Password” fields, when configuring VMU-C the two fields in question shall not be filled in.

3.1.12 UPDATING THE VMU-C FIRMWARE

Clicking on the “FIRMWARE” item will grant access to the page shown below.

VMU-C FIRMWARE UPDATE	
VMU-C Serial Number	BL3080002001U
MAC Address	00-19-EE-10-00-37
Installed Firmware Version	Ver. NEWG_PUSH_A14_A26
VMU-C Update	Browse... <input type="button" value="Load"/>
Check FTP Server for Latest Update	<input type="button" value="Check"/>
Download Update Package	<input type="button" value="Download"/>
Install Update Package	<input type="button" value="Install"/>
Timestamp	Status
2014-05-09 07:15:20	FTP Connection Error (Code: -6)

Firmware update

This page is split in 2 areas relevant to 2 ways of updating the VMU-C:

- a) Manual update
- b) Automatic update

3.1.12.1 MANUAL UPDATE

Manual update allows to upgrade the current firmware release by uploading and installing a new firmware package file (provided by Carlo Gavazzi organization) by means of a PC. Pressing the “Browse” button will open a window allowing to specify where the firmware update file has been saved; as soon as you select the file, VMU-C will display the above window again, replacing the “Browse” caption with “OK” (the update file must be obtained from the Carlo Gavazzi technical support. Pressing the “Load” button will open a window prompting user to confirm the firmware update operation. As soon as the update operation is confirmed, the system will prompt you to confirm the operation under way.

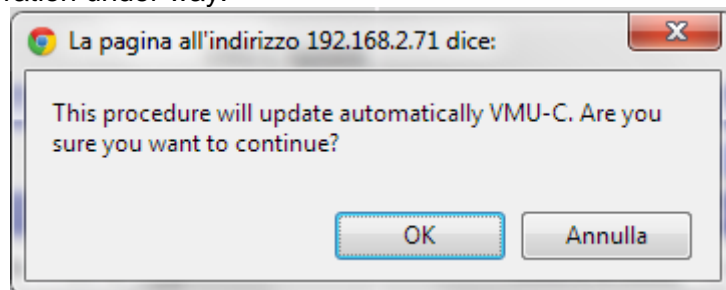

FIRMWARE update confirmation

As soon as user gives OK to proceed with the firmware update operation the system will display the screen shown below:



Firmware update splash screen

Time to finalize installation depends on the actual VMU-C load (in terms of connected devices), Internet connection speed and size and complexity of the update package.

Note: the time necessary to the system for loading the update depends on the speed of the Internet/LAN connection between the PC and VMU-C and could last for several minutes, particularly in connection with cellular modem. Wait for the report to confirm the successful download.

Notes: updating operation cannot be interrupted after launching the Update command. Do not launch a new update before the system has completed the first one.

Notes: Major updates introducing brand new important features need time to be finalized.

3.1.12.2 AUTOMATIC UPDATE

The automatic update is managed by the following subsection of the main Firmware Update page:

Check FTP Server for Latest Update	Check
Download Update Package	Download
Install Update Package	Install

Automatic update

The process is menu – driven, and it is thus error-proof; the three steps are:

Button	Action
Check	Checks if a new updating package is ready

	on Carlo Gavazzi's servers
Download	Enabled if CHECK is successful; it starts the package download from Carlo Gavazzi's servers; at the end of the download step it is possible both to start installation and also to check again (the latter chance is useful in the case the download has not been followed by Install and time has passed by)
Install	Enabled if DOWNLOAD is successfully finalized; it starts the package installation

Note: the time necessary to the system for loading the update depends on the speed of the Internet/LAN connection between the PC and VMU-C and could last for several minutes, particularly in connection with cellular modem. Wait for the report to confirm the successful download.

Notes: Major updates introducing brand new important features need time to be finalized.

3.1.12.3 FIRMWARE UPDATE – SERVER SETTINGS

After having been officially authorized by Carlo Gavazzi, an user could setup a firmware update server in its own IT infrastructure. This is useful in the case of complex organizations needing to apply special firmware deployment policies.

In this case it is possible to configure an alternate server, under the user responsibility, to be accessed as the VMU-C firmware repository.

FIRMWARE UPDATE - SERVER SETTINGS

Carlo Gavazzi Official FTP Server

Custom FTP Server

FTP Server Address

Remote Directory

Server User

Server Password

Save Setting

Test Connection

Firmware Update –custom FTP server

By the relevant fields it is possible to configure the client so as to communicate with the FTP server :

- FTP server address: IP or Internet address of the target FTP server
- Remote directory: directory where the firmware packages are stored within the FTP server
- Server user: user name to access the above directory
- Server password: password to access the above directory

Note: setting up a custom FTP repository needs special training on the relevant procedures to allow firmware package deployment. Please contact Carlo Gavazzi Support for further information.

VMU-C

Note: setting up a custom FTP repository needs special training on the relevant procedures to allow firmware package deployment. Please contact Carlo Gavazzi Support for further information.

3.1.13 TOOLS

REMOTE REBOOT	
VMU-C Reboot	Reboot
SETTING VMUC-EM'S DATE AND TIME - VMU-M EM'S SYNCHRONIZATION	
VMU-C's Date <input type="text" value="27-06-2014"/> ...	VMU-C's Time <input type="text" value="14"/> <input type="text" value="44"/> <input type="text" value="20"/> hh:mm:ss
<input type="checkbox"/> Synchronize with PC's time	Adjust
SYSTEM DATA RESET	
Password <input type="text"/>	Confirm Password <input type="text"/>
Yield Data Reset	Reset
Events Reset	Reset
VMU-M EM, Environmental Sensors and Energy Meters Reset	Reset
Reset of Yield Data and Plant Settings	Reset
Restore Factory Settings	Reset

The TOOLS menu

By the tools menu it is possible to:

- a) Reboot VMU-C
- b) Setting up Time and Date
- c) Resetting VMU-C

3.1.13.1 VMU-C REBOOT

VMU-C can be restarted through the "REBOOT" button.

REMOTE REBOOT	
VMU-C Reboot	Reboot

After issuing the command you will be prompted to confirm that you wish to proceed,

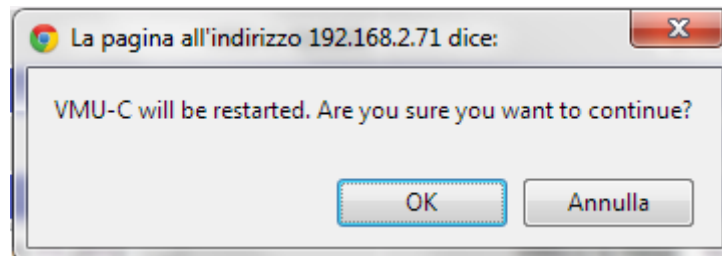

then a countdown will displayed. When it is completed, you will be addressed back to the home page .

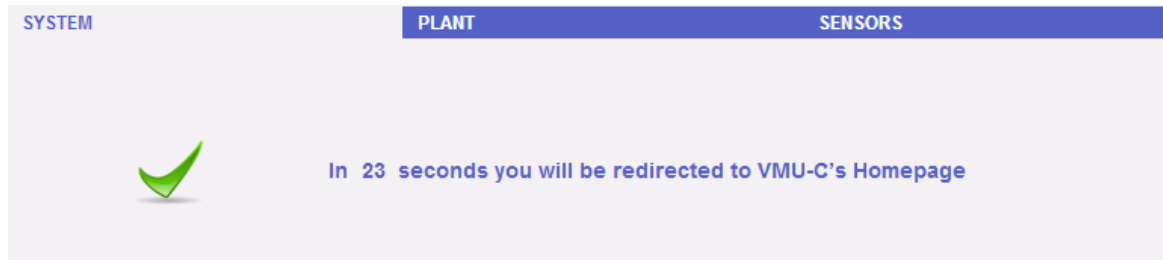

Note: during update and restart, web pages can show error messages as VMU-C cannot be temporarily reached.
Wait for a few seconds before restoring connection.

3.1.13.2 DATE, TIME AND VMU-M CONFIGURATION

By pressing the “**Set**” button you can set the VMU-C internal date and time on all the VMU-M devices connected to VMU-C. If you select the “Synchronise with ...” function the date and time sent to the VMU-C and as a consequence to the VMU-M devices connected to it will be those of the PC in use .

SETTING VMUC-EM'S DATE AND TIME - VMU-M EM'S SYNCHRONIZATION

VMU-C's Date ... VMU-C's Time hh:mm:ss

Synchronize with PC's time **Adjust**

SYSTEM DATA RESET

3.1.13.3 RESETTING SYSTEM DATA

VMU-C provides 5 different Reset commands :

SYSTEM DATA RESET

Password Confirm Password

Yield Data Reset	Reset
Events Reset	Reset
Eos-Arrays, Environmental Sensors and Energy Meters Reset	Reset
Reset of Yield Data and Plant Settings	Reset
Restore Factory Settings	Reset

- 1) Yield data reset: it will reset all the production data stored in the internal memory of VMU-C and in the VMU-M devices connected to it (if a memory card has been installed in VMU-C, it is not affected by the Reset command).
- 2) Events reset: it will reset all the events stored in VMU-C and in the VMU-M devices connected to it (if a memory card has been installed in VMU-C, it is not affected by the Reset command).
- 3) Eos-Array, environmental sensor and meter reset: it will reset all the environmental sensor data recorded in VMU-C and in the VMU-M devices connected to it (temperatures, radiance and wind speed), as well as the values of the plant kWh meters (if a memory card has been installed in VMU-C, it is not affected by the Reset command).
- 4) Yield data and plant settings reset: It combines the three Reset commands described above; it also resets the plant configuration (it doesn't reset the data concerning the IP address, the SMTP mail server data and all the previously input e-mail addresses).

VMU-C

- 5) *Restore Factory Settings*: it performs the reset operations described at point 4; it also resets all the settings like IP address, SMTP server and alarm management by e-mail (if a memory card has been installed in VMU-C, it is not affected by the Reset command). Default data (factory settings) will be restored.

Note: to be able to execute any of the reset commands described above , you first need to enter the Administrator "Password".

3.1.14 LANGUAGE SETTING

Hovering the mouse cursor over “SYSTEM” will display a drop-down menu; click on “LANGUAGE”; the relevant section will be displayed. From the drop-down menu select the desired language. The system will also display the date and time formats currently in use. “Decimal Separator” box allows the choice between “.” and “,” as decimal separator in all the file which will be exported by VMU-C.

LANGUAGE	
Language Selection	English UK 
ENGINEERING UNITS	
Date Format	Day - Month - Year
Time Format	Hours : Minutes : Seconds AM/PM
Data Export: Decimal Separator	.
TIME ZONE	
Area	Location
Europe	Rome
Apply	

Language setting

You will also have to provide the following information:

- Geographic area
- City

This information is required for time management inside VMU-C EM.

3.1.15 WEB SERVER SETTING

SYSTEM

- DATA PLANT
- LAN SETTING**
- NTP SERVER
- WEB SERVER**
- PUSH SERVICES
- MODBUS TCP
- MODEM
- ALARMS
- PLANNING
- E-MAIL
- FIRMWARE
- TOOLS
- LANGUAGE
- USER INTERFACE

HTTP / HTTPS SETTINGS

HTTP Protocol

Port

HTTPS Protocol

Port

Enable port forward from HTTP

Save Setting

By means of this feature it is possible to:

1. Activate VMU-C's HTTP web server on standard unsecure port 80, or change the default HTTP port to another port of choice
2. Activate VMU-C's secure HTTPS web server on standard port 443, or change the default HTTP port to another port of choice
3. To Enable automatic port forwarding from HTTP to HTTPS so as to use always use the embedded web server in secure mode.

Note: please avoid forgetting ports after having changed both HTTP and HTTPS ports: in this case it will be impossible to use the web-server again.

3.2 PLANT CONFIGURATION

Hovering the mouse over “PLANT” will display a drop-down menu consisting of three items: “COM SETUP”, “DRIVER” and “SETTING”

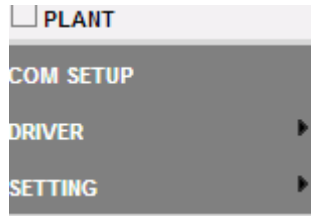

Plant Configuration Menu

3.2.1 COM SETUP

Hovering the mouse over “COM Setup” will grant access to the page shown below, relevant to COM1 port according to the relevant RS485 parameters. The configuration of the “COM 2” port must be carried out during the configuration of the energy meters / inverters connected to VMU-C.

COM PORT SETUP	
COM1 (EOS-ARRAY)	
Baud Rate	9600 ▼
Parity	None ▼
Data bits	8 ▼
Stop bits	1 ▼
<input type="button" value="Save Setting"/>	

COM port Setup

Note: The communication port RS485 (COM 1) is specifically designed for the communication with the VMU-M belonging to the system and controlled by VMU-C.

Define the following parameters in this page:

- **Baud-rate** (selectable values are: 9600, 19200, 38400 and 115200 bps)
- **Parity** (selectable values are: none, odd or even)
- **Data bits** (selectable values are 8 or 7 bits)
- **Stop bits** (selectable values are 1 or 2 bits)

Press “Save setting” to store data.

3.2.2 DRIVERS

Hovering the mouse cursor over “DRIVERS” will display two items: LIST and IMPORT.

- Clicking the LIST item will grant access to the page shown below listing (in alphabetical order) all the drivers of the compatible energy meters in VMU-C EM.

AVAILABLE DRIVER LIST			
BRAND	DRIVER	VERSION	INSTRUMENT
CARLO GAVAZZI	EM12	1.2	Energy Meter
CARLO GAVAZZI	EM21	2.3	Energy Meter
CARLO GAVAZZI	EM21_R	1.2	Energy Meter
CARLO GAVAZZI	EM23	1.1	Energy Meter
CARLO GAVAZZI	EM24	1.1	Energy Meter
CARLO GAVAZZI	EM26	1.1	Energy Meter
CARLO GAVAZZI	EM33	2.1	Energy Meter
CARLO GAVAZZI	VMU-E_DIRECT	1.1	Energy Meter
CARLO GAVAZZI	VMU-E_SENSOR	1.1	Energy Meter
CARLO GAVAZZI	VMU-E_SHUNT	1.1	Energy Meter
CARLO GAVAZZI	WM30	2.2	Energy Meter
CARLO GAVAZZI	WM40	2.3	Energy Meter

Driver list

From version A8 of the VMU-C EM firmware, the driver list includes also Modbus/TCP drivers; see the relevant section dedicated to the MODBUS MASTER function.

DRIVER IMPORT PROCEDURE	
Select the file using the 'Browse' button	<input type="button" value="Browse..."/>
Press the 'Load Driver' key to load the selected driver	<input type="button" value="Load Driver"/>
Confirm New Driver Activation	<input type="button" value="Activate"/>

Driver Import

Clicking on the "IMPORT" item will grant access to the page shown above, allowing to import any new drivers made available by “Carlo Gavazzi Controls” .. Once the new driver(s) loading procedure is completed, press the “Activate” button to actually enable the driver.

Note: due to the complexity of the implemented functions, some driver require that some low-level firmware functions are enabled at the same time. In this case you may have to update the whole VMU-C firmware.

3.2.3 PLANT SETTING

When hovering the mouse over “Setting”, the system will display the two items WIZARD and SAVE CONFIGURATION .

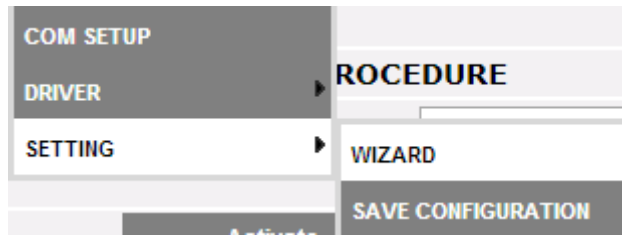

If the VMU-C configuration has already been completed, clicking on the SAVE CONFIGURATION item will allow to export it to a file with “DB” extension and to save it to one's PC, allowing it to be uploaded to the present or different VMU-C at a later time.

Clicking on the WIZARD item will grant access to the page shown below, displaying four new sub-menus:

- Detect Connected Instruments
- Manual configuration
- Restore Configuration
- Import

VMU-C SETTINGS	
Autoscan Devices Connected to VMU-C	Find Connected Devices
Perform the manual configuration of the devices connected to the VMU-C	Manual Setup
Resume Configuration	Resume Configuration
Load Configuration from File	Import

Plant Configuration Wizard

Clicking on the “*Find Connected Devices*” item will grant access to the page shown in above; through the “Start Scanning” command, it allows to launch the procedure of “self-detection” of the modules connected to the auxiliary bus of VMU-C and of the devices connected to the COM1 communication port (VMU-M and relevant modules).

Note: before starting the configuration procedure described below, the relevant Mod-BUS address (Mod-BUS node number) must have been assigned for all the VMU-M modules. There must not be two devices having the same node number on the same communication bus.

Note: the scanning operation can only detect the devices which are properly connected and powered. The self-detection operation only refers to the COM1 communication bus. Any devices existing on COM2 shall be configured manually.

Autoscan Devices Connected to VMU-C		
	VMU-C	COM 1
Modbus Address	---	---
Found Devices	---	---
Scan Status	---	---
Start Scan		

VMU-C setting

Once the procedure for the automatic detection of the connected devices is completed, the system will display the page shown below listing the amount of the devices detected for the COM1 port and for the COM Aux port of the VMU-C EM. If all the devices connected to the ports (COM1 e COM Aux) have been detected, you can stop the automatic scanning procedure through the “*Stop scanning*” command.

AUTOSCAN DEVICES CONNECTED TO VMU-C		
	VMU-C	COM 1
Modbus Address	---	---
Found Devices	---	---
Scan Status	---	---
<input type="button" value="Start Scan"/>		

VMU-C EM setting

If the scanning procedure has been successfully completed, save the resulting information by pressing the “*Save Configuration*” button

Scan Status	Terminate	Terminate
<input type="button" value="Save Configuration"/>		
<input type="button" value="Cancel"/>		

VMU-C EM setting

- Clicking on the “*Save Configuration*” item will grant access to the page shown below

Clicking on the “*Manual setup*” item will grant access to the manual configuration section shown below . From now on the configuration of the whole system will start.

Note: the user will be able to ADD, MODIFY or REMOVE any VMU-M EM devices even after they have been automatically detected.

MANUAL SETUP							
START	VMU-O	EM	VMU-P		VMU-M	VMU-C	END
<input type="button" value="Back"/>			<input type="button" value="Next"/>				
<input type="text" value="VMU-M"/>			<input type="button" value="Add"/>				
Address		Description [Devices Connected]					
VMU-C EM							
	1	VMU-M_001	[01]	<input type="button" value="Remove"/>		<input type="button" value="Modify"/>	

Manual setup

Note: The LED on the left in figure 32 can take on 3 different colours, having the following meanings:

- **GREEN:** configuration OK and serial communication enabled
- **YELLOW:** configuration OK but serial communication not enabled.
- **RED:** error in configuration data. Communication with the relevant module will be impossible.

VMU-C

- Clicking on the “Modify” button allows to display and modify the structure of the VMU-C EM and of each individual VMU-M EM adding or removing any VMU-x modules.
- You can modify the serial communication address of the specific VMU-M EM module.
- You can assign a specific group description (this way it might be easier to identify the board during monitoring)
- You can also associate a further descriptive note with the specific VMU-M EM module.
- The command “Enable VMU-M EM COM1 communication” allows to enable the communication between the VMU-C EM master and the relevant VMU-M EM. Should communication be disabled, during the scanning procedure the master VMU-C EM will not query the specific VMU-M EM.

The screenshot displays the 'VMU-C SETTINGS' interface. At the top, there is a header 'VMU-C SETTINGS' and a row of 'Position' labels: 0, 1, 2, 3, 4. Below this is a diagram of the hardware layout with five columns corresponding to the positions. The first column (Position 0) contains a large blue 'C' button. The second column (Position 1) contains a large blue 'O' button. The third column (Position 2) contains a large blue 'P' button. The fourth and fifth columns (Positions 3 and 4) contain large blue buttons with question marks. Below the diagram, there are two input fields: 'Description' with the text 'VMU-C EM' and 'Notes' with the text 'Local Bus'. At the bottom, there are two buttons: 'Back' and 'Save'.

VMU-C EM setting

Clicking on the “Next” button from the “Manual setup” page will grant access to the configuration of the individual devices, like energy meters, VMU modules and relevant sensors.

3.2.4 CONFIGURATION OF THE VMU-O MODULES (VMU-O EM)

If during the “device auto-detection” stage one or more VMU-O modules have been identified (there may be up to 3 VMU-O modules for each VMU-C EM e/o VMU-M EM), the system will display the screen shown below -

The procedure for the auto-detection of the modules connected to COM1 scans all the devices existing on this port, stores their position and displays the current configuration.

VMU-O module configuration mask

The system will automatically display the information concerning the source base module (VMU-C EM or VMU-M EM) and the location of the VMU-O module within the system.

Indicate for each of the two outputs (Output1 and Output2) the function to be applied (Remote, Alarm, Clock):

VMU-O usage modes

- *Remote*: Activation and deactivation are performed through a special command sent by the operator through VMU-C.
- *Alarm*: The output is associated with an alarm condition coming from local VMU modules connected by local bus to the target VMU O (i.e. temperature setpoint on the VMU-P): in this case the alarm management is made locally by the VMU-M master. This selection also allows to define the initial state of the relay (Normally closed or Normally open).
- *Clock*: Activation and deactivation are carried out at the time set in VMU-C.
- *Global*: The output is associated with an alarm condition coming from VMU-C (i.e. an Energy meter voltage setpoint): in this case the alarm management is made remotely by the VMU-C. This selection also allows to define the initial state of the relay (Normally closed or Normally open).

Clicking on the “Next” button from the “Manual setup” page (Fig. 32) will grant access to the EM (Energy Meter) configuration page -

3.2.5 ENERGY METER CONFIGURATION

Clicking on the “Next” button again from the “Manual setup” page will grant access to the Energy Meter configuration page

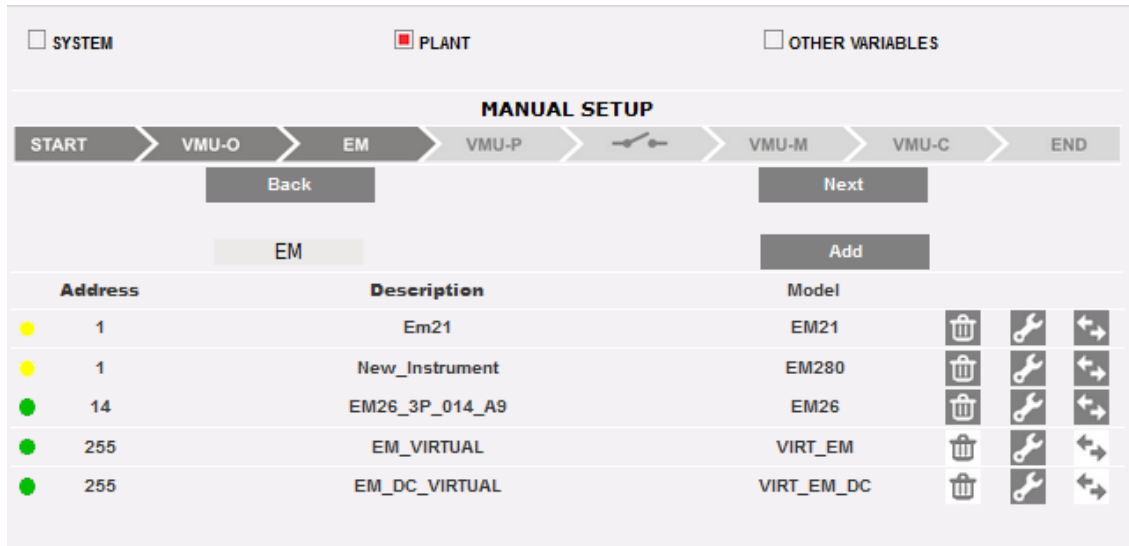

Energy meter configuration

3.2.5.1 ENERGY METER ADDITION

Clicking on the “Add” button will display the mask allowing to select the configuration model -

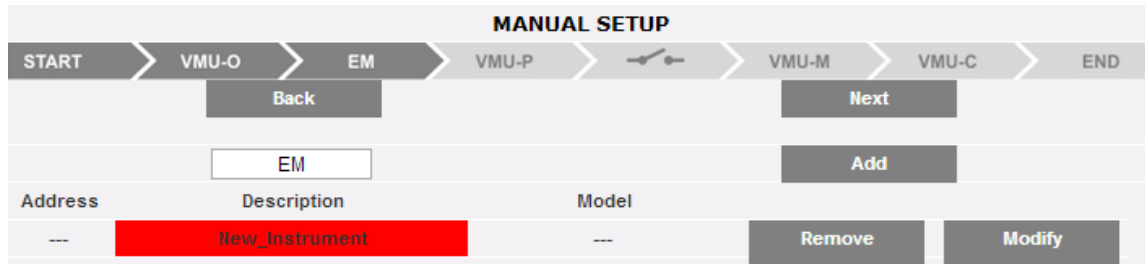

Energy meter addition

Click on the “Modify” button to access the detailed Energy Meter configuration .

SYSTEM
 PLANT
 OTHER VARIABLES

ENERGY METER CONFIGURATION

Brand: CUSTOM
 Model: EM21
 Configuration: THREE-PHASE
 Phase:
 Address: --- Converter ---
 Description: Em21
 Enable communication:
 Enable Contribution to the Virtual Main Meter:

Notes:

Baud Rate/ Data bits/Parity/Stop bits: 9800 8 None 1

Energy meter configuration

SYSTEM
 PLANT
 OTHER VARIABLES

ENERGY METER CONFIGURATION

Brand: CARLO GAVAZZI
 Model: EM280
 Configuration: 3P/3.1P
 Phase:
 Address: --- Converter ---
 Description: New_Instrument
 Baud Rate/ Data bits/Parity/Stop bits: 9800 8 None 1

GROUPS

	Description	Address	Phase	Enabl.	Contr.	
●	SUM	---		<input type="checkbox"/>	<input type="checkbox"/>	
L ●	SYS	---		<input type="checkbox"/>	<input type="checkbox"/>	
L ●	Load 1	---	Phase 1	<input type="checkbox"/>	<input type="checkbox"/>	
L ●	Load 2	---	Phase 1	<input type="checkbox"/>	<input type="checkbox"/>	
L ●	Load 3	---	Phase 1	<input type="checkbox"/>	<input type="checkbox"/>	

Energy meter configuration for meters with multiple variables' groups

VMU-C

In the case of complex meters, multiple variables groups are included in the same configuration (this is the case for EM270 family). In the example above, 3 groups are represented:

SUM group (embedded SUM counter)

SYS (system group) with the system variables

LOAD groups, with the single-phase variables

Through the drop-down menu of the “Brand” field select the name of the Energy Meter manufacturer

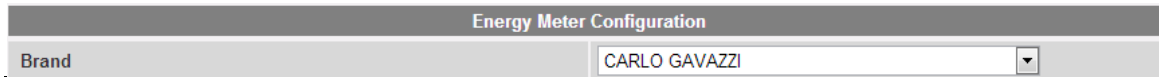

The screenshot shows a window titled "Energy Meter Configuration". At the top, there is a dropdown menu for "Brand" which is currently set to "CARLO GAVAZZI".

Select the specific model of the energy meter you are configuring through the drop-down menu of the “Model” field

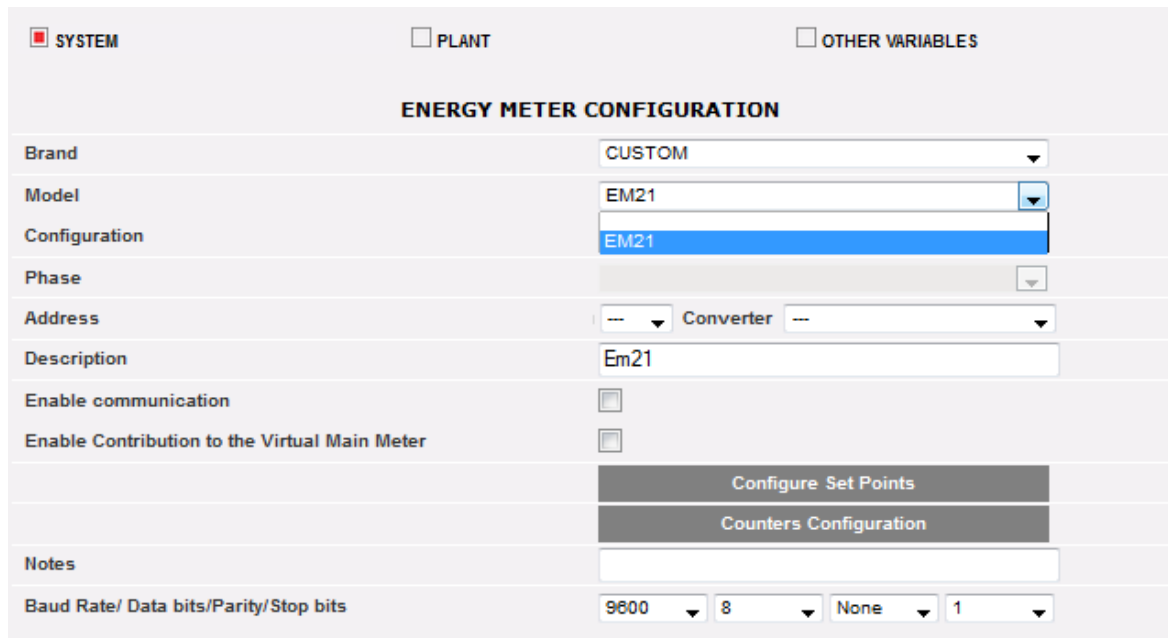

The screenshot shows the "ENERGY METER CONFIGURATION" window. At the top, there are three radio buttons: "SYSTEM" (checked), "PLANT", and "OTHER VARIABLES". Below this, the "Brand" field is set to "CUSTOM". The "Model" field is set to "EM21", and a dropdown menu is open showing "EM21" as the selected option. Other fields include "Configuration" (set to "EM21"), "Phase", "Address" (with a "Converter" dropdown), "Description" (set to "Em21"), "Enable communication" (checkbox), "Enable Contribution to the Virtual Main Meter" (checkbox), "Notes", and "Baud Rate/ Data bits/Parity/Stop bits" (set to 9600, 8, None, 1). There are also buttons for "Configure Set Points" and "Counters Configuration".

Compatible EM models list

Complete the Energy Meter configuration by configuring the following fields:

- Configuration:** this is a parameter valid for those meters which embed multiple available working modes (like the CG’s EM270 family); in this case it is mandatory to select the driver’s configuration matching the right working mode
- Phase:** the target phase in the case of single phase meters monitoring one specific phase of a 3-phase system
- Address (Modbus):** specify the address configured on the Energy Meter.

Note: within the same RS-485 network there may be no two energy meters (or other devices) having the same address. The presence of two or more instruments having the same address prevents communication with them.

- d) **Description:** label to be assigned to the Energy Meter. We recommend that you name instruments in progressive order to easily identify them during data or alarm search.

Note: we recommend that you assign a different “Description” to the instruments.

- e) **Enable communication:** it enables the serial communication of the instrument with VMU-C EM
- f)
- g) **Enable contribution to the virtual main meter:** if no main instrument has been defined (from the configured instrument list), VMU-C EM will automatically create a virtual instrument (one for AC energy and one for DC energy). It will represent the sum of all the real instrument having this option enabled.
- h) **Notes:** notes field.
- i) **Baud rate** (bps): specify the communication rate (9600, 19200, 38400 or 115200) previously set on the instrument.
- j) **Data bits:** specify the data format used by the instrument (7 or 8 bits).
- k) **Parity:** specify the communication parity type (no parity, even parity, odd parity); it shall match the values set on the instrument.
- l) **Stop bits:** specify the number of stop bits (1 or 2 bits); it shall match the values set on the instrument.

Pressing the “Save” button will add the energy meter to the list

Note: the “Description” field box can take on 3 different colours, having three different meanings:

- **GREY** : configuration OK and serial communication enabled
- **YELLOW:** configuration OK but serial communication not enabled.
- **RED:** error in configuration data. Communication with the relevant module will be impossible.

Click on the “Add” button again to add other energy meters.

There are also 2 available push buttons:

- a) Configure Set Points: to set the relevant thresholds on which to trigger alarms
- b) Counters Configuration: to configure the pulse totalizer inputs

3.2.5.2 MODBUS/TCP METERS

From firmware release A8, also MODBUS/TCP meters can be connected by Ethernet to the VMU-C EM allowing it to gather data from them (see the section dedicated to “MODBUS/TCP MASTER” functions).

The relevant parameters in this case are:

- a) **Configuration:** this is a parameter valid for those meters which embed multiple available working modes (like the CG’s EM270 family); in this case it is mandatory to select the driver’s configuration matching the right working mode
- b) **Phase:** the target phase in the case of single phase meters monitoring one specific phase of a 3-phase system
- c) **IP Address:** the IP address configured on the Energy Meter.
- d) **Port:** TCP/IP port dedicated to Modbus/TCP communication with the target meter
- e) **Slave:** Modbus address of the target meter; it is not needed in the case of Carlo Gavazzi meters with embedded Ethernet interface; it is necessary in the case of Modbus/RTU meters connected to LAN through a Modbus/RTU to Modbus/TCP converter

Note: within the same RS-485 network there may be no two energy meters (or other devices) having the same Modbus address. The presence of two or more instruments having the same address prevents communication with them.

- f) **Description:** label to be assigned to the Energy Meter. We recommend that you name instruments in progressive order to easily identify them during data or alarm search.

Note: we recommend that you assign a different “Description” to the instruments.

- g) **Enable communication:** it enables the Modbus/TCPI communication of the instrument with VMU-C EM
- h) **Enable contribution to the virtual main meter:** if no main instrument has been defined (from the configured instrument list), VMU-C EM will automatically create a virtual instrument (one for AC energy and one for DC energy). It will represent the sum of all the real instrument having this option enabled.
- i) **Notes:** notes field.

3.2.5.3 CONFIGURING SET-POINTS

Press the “Configure Set-Points” button to access the alarm configuration page.

ENERGY METER CONFIGURATION	
Brand	CARLO GAVAZZI
Model	WM30
Address	1
Description	WM30_1
Energy Meter COM 2 Communication Enabling	<input checked="" type="checkbox"/>
Define as Main Meter	<input type="checkbox"/>
Enable Contribution to the Virtual Main Meter	<input checked="" type="radio"/> Yes <input type="radio"/> No
<input type="button" value="Configure Set Points"/>	

Button granting access to the alarm configuration page

It grants access to the configuration page allowing to configure up to 8 different alarms for each instrument.

ENERGY METER CONFIGURATION				
				General Setting
Enabled variables	Set-Point 1	Set-Point 2	On-Time Delay (s)	Alarm Type
VLNsys	220.0	210.0	5	Virtual
VLNsys	220.0	210.0	0	Virtual
---	0.0	0.1	0	Disabled
---	0.0	0.1	0	Disabled
---	0.0	0.1	0	Disabled
---	0.0	0.1	0	Disabled
---	0.0	0.1	0	Disabled
---	0.0	0.1	0	Disabled

alarm configuration page

The following fields need to be configured for each alarm:

- Enabled variables: from the drop-down menu you can choose a variable among the ones included in the list displayed by the system:

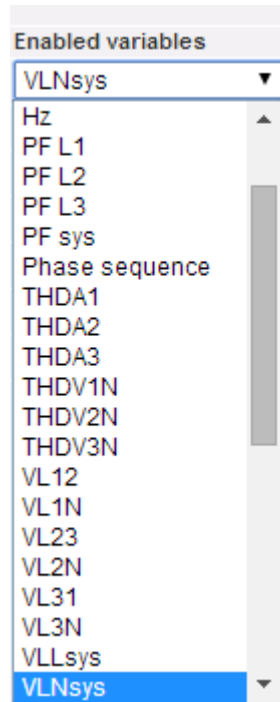

Enabled variables

In case of DC energy meter, the available variable list is limited to current, voltage, power and DC energy.

- **Set-Point1:** it indicates the alarm activation value (MAXIMUM alarm with Set-Point1 \geq Set-Point2; MINIMUM alarm with Set-Point1 $<$ Set-Point2)
- **Set-Point2:** specify the alarm activation value. (MAXIMUM alarm with Set-Point1 \geq Set-Point2; MINIMUM alarm with Set-Point1 $<$ Set-Point2)
- **On-time delay (s):** specify the delay in seconds associated with the alarm activation (waiting time during which the variable stays above or below the Set-Point1 value before the alarm condition is signalled).
- **Alarm type:** specify the type of alarm you wish to manage. Up to three options may be available: Disable, Virtual or Real.
 - a) **Disabled:** though configured, the overstepping of the set threshold will not generate any message or alarm action.
 - b) **Virtual:** the overstepping of the set threshold will generate an alarm message which will not result in the activation of any digital outputs.
 - c) **Position :** this option will only be available when there is at least a VMU-O module connected to the internal bus of the VMU-C EM and at least one of the two available outputs is set for remote control. When the alarm threshold is overstepped, the alarm message will be sent, and in addition the status of the selected digital output will change.

3.2.6 COUNTERS CONFIGURATION

Press the “Counters configuration” button to access the page allowing to configure the digital input meters (of any) of the energy meters.

Button granting access to the meter configuration page

You will access the configuration page allowing to set for each digital input a description, the engineering unit, the amount of digits after the decimal point and the relevant enabling.

ENERGY METER CONFIGURATION						
					Select all	Deselect All
Description	Engineering Units	Decimal Position	Enabled	Present value	Set value	
kWh+	kWh		<input type="checkbox"/>	47901.91	<input type="checkbox"/>	
kWh-	kWh		<input type="checkbox"/>	0.45	<input type="checkbox"/>	
kvarh+	kvarh		<input type="checkbox"/>	0.74	<input type="checkbox"/>	
kvarh-	kvarh		<input type="checkbox"/>	61301.60	<input type="checkbox"/>	

Digital input meter configuration page

- **Description:** label to be assigned to the Meter (like GAS Meter, WATER Meter, etc.) for easier searching.
- **Engineering units:** the engineering unit referring to the digital input meters.
- **Decimal position:** number of digits after the point. The point position is defined by the instrument.
- **Enabled:** it specifies whether the meter is enabled or disabled. If it is not enabled, the value and the label will not be displayed.
- **Present value:** it is the actual value of the given Totalizer
- **Set value:** it is the desired value of the given totalizer (it can be set after checking the relevant check button on the left); this value overwrites the actual totalizer

Press the “Save” button to confirm the newly entered settings.

3.2.7 ENERGY METER DELETION

Press the “Remove” button to delete an instrument from the list of the configured energy meters.

MANUAL SETUP							
START	VMU-O	EM	VMU-P		VMU-M	VMU-C	END
Back			Next				
EM			Add				
Address	Description	Model	Remove	Modify	Substitute		
1	WM30-R&D_Belluno	WM30	Remove	Modify	Substitute		
2	EM21-R&D_Belluno	EM21	Remove	Modify	Substitute		
10	VMU-E_10_-R&D_Belluno	VMU-E-AV00_DIRECT	Remove	Modify	Substitute		
11	VMU-E_11_-R&D_Belluno	VMU-E-AV00_DIRECT	Remove	Modify	Substitute		

Energy Meter insertion/removal mask

The system will display a message prompting to confirm the operation :

Press ‘YES’ to confirm deletion or “NO” to cancel. If you press “YES” the Energy Meter will be removed from the Inserted Meter list. All data acquired from VMU-C EM up to that moment on the deleted Energy Meter will be definitively eliminated.

Note: energy meter insertions, modifications and deletions will come into effect only after the new plant configuration is sent through the specific command. The machine doesn't need to be restarted.

3.2.8 ENERGY METER SUBSTITUTION

Press the “Substitute” button to substitute an instrument from the list of the configured energy meters. This feature is very useful in the case of a failure in a specific energy meter, after which it is necessary to physically change the meter with another item; the system will advise the user in the case the substituting meter manages less variables than the substituted one (e.g. in the case of different model)

MANUAL SETUP							
START	VMU-O	EM	VMU-P		VMU-M	VMU-C	END
Back			Next				
EM			Add				
Address	Description	Model	Remove	Modify	Substitute		
1	WM30-R&D_Belluno	WM30	Remove	Modify	Substitute		
2	EM21-R&D_Belluno	EM21	Remove	Modify	Substitute		
10	VMU-E_10_-R&D_Belluno	VMU-E-AV00_DIRECT	Remove	Modify	Substitute		
11	VMU-E_11_-R&D_Belluno	VMU-E-AV00_DIRECT	Remove	Modify	Substitute		

Energy Meter substitution mask

By completing the relevant form, it is possible to set-up the incoming meter’s parameters. The system will preserve the history of logged data and treat the variables logged from the new meter like a continuation of the time series logged from the old meter

INSTRUMENT SUBSTITUTION	
Is now possible to replace the instrument and proceed with the configuration.	
Brand	CARLO GAVAZZI
Model	WM30
Address	1
Description	WM30-R&D_Belluno
Energy Meter COM 2 Communication Enabling	<input checked="" type="checkbox"/>
Define as Main Meter	<input type="checkbox"/>
Enable Contribution to the Virtual Main Meter	<input checked="" type="radio"/> Yes <input type="radio"/> No
Notes	
Baud Rate	9600
Data bits	8
Parity	None
Stop bits	1
<div style="display: flex; justify-content: space-between;"> Back Next </div>	

Energy Meter substitution form

Press NEXT to configure the OFFSET (if it is necessary) and then SAVE to confirm the changes

3.3 VMU-P MODULE CONFIGURATION

if one or more VMU-P modules are identified during the “auto-detection” procedure, the system will display the screen shown below (for each VMU- M EM there may be no more than 1 VMU-P module; VMU-C EM can manage up to 11 VMU-P modules). The procedure for the auto-detection of the VMU-M EM scans all the devices existing on the COM1 port, stores their position and displays the current configuration.

START	VMU-O	EM	VMU-P	←	VMU-M	VMU-C	END
Back				Next			
Base Module	VMU-C	VMU-C EM (Addr. 1)		VUM-P Module Position	2		
VMU-P (MV)							
Temperature Measure	Temperature ch.1 and ch.:		Probe Type	Pt100 3-Wire			
Analogue Input Measure	Enabled		Pulse Rate Input Measure	Disabled			
Temperature ch.1	Temperature ch.2	Analogue Input	Pulse Rate Input	Error Management			
Alarm Type				Position 1, VMU-O: Chann.			
Alarm Set-point 1 (°C) (S1 >= S2 Up Alarm; S1 < S2 Down Alarm)				-2.0			
Alarm Set-point 2 (°C) (S1 >= S2 Up Alarm; S1 < S2 Down Alarm)				-4.0			
Alarm Activation Delay Filter				0			

VMU-P module configuration mask

In the area marked by the dots the system will automatically display the information concerning the source base module (VMU-C EM or VMU-M EM) and the location of the VMU-P module within the system.

Specify for each module which temperature measurements shall be monitored (Temperature of channel1, of channel 2 or both) and the type of sensor to be used (Pt100 or Pt1000 probes, 3 wires or 2 wires).

For each module you can also enable (or disable) the measurements from the analogue inputs and from the frequency input (pulse input).

3.3.1 ALARM CONFIGURATION ON VMU-P MODULES

Each VMU-P module can manage specific alarms for each of the monitored dimensions :

- Channel 1 temperature
- Channel 2 temperature
- Analogue input (mV or mA)
- Pulse rate input

Temperature ch.2	Temperature ch.1	Analogue Input	Pulse Rate Input	Error Management
Alarm Type				Virtual
Alarm Set-point 1 (°C) (S1 >= S2 Up Alarm; S1 < S2 Down Alarm)				150.0
Alarm Set-point 2 (°C) (S1 >= S2 Up Alarm; S1 < S2 Down Alarm)				120.0
Alarm Activation Delay Filter (seconds) (On-Time Delay)				10

VMU-P alarm configuration mask

For each alarm you can define the activation thresholds and the relevant usage mode:

- Rising alarm: Threshold1 ≥ Threshold2
- Dropping alarm: Threshold1 < Threshold2

Each alarm can be disabled, or be enabled as a Virtual Alarm, or you can link each individual alarm to a digital output

Temperature ch.2	Temperature ch.1	Analogue Input	Pulse Rate Input	Error Management
Alarm Type				Virtual
Alarm Set-point 1 (°C) (S1 >= S2 Up Alarm; S1 < S2 Down Alarm)				150.0
Alarm Set-point 2 (°C) (S1 >= S2 Up Alarm; S1 < S2 Down Alarm)				120.0
Alarm Activation Delay Filter (seconds) (On-Time Delay)				10

VMU-P alarm configuration mask

Each alarm can be associated with a different “Alarm activation delay filter” value (a value expressed in seconds, which can range between 0 and 3600).

To configure the alarm triggered by the “analogue input” and by the frequency input (pulse input), besides the alarm thresholds Threshold1 and Threshold2 you also need to set the data specific to the installed sensor:

- Electric scale – Minimum Value (mV): parameter related to the electrical input (minimum value of the input signal).
- Electric scale – Maximum Value (mV): parameter related to the electrical input (maximum value of the input signal).
- Displayed scale – Minimum Value: Minimum value (expressed in the engineering unit specified above) at the minimum input value (mV).
- Displayed scale – Maximum value (expressed in the engineering unit specified above) at the maximum input value (mV).

Temperature ch.1	Temperature ch.2	Analogue Input	Pulse Rate Input	Error Management
Electrical Scale - Min. Value (mV)		<input type="text" value="0.0"/>	Electrical Scale - Max. Value (mV) <input type="text" value="120.0"/>	
Display Scale - Min. Value		<input type="text" value="0"/>	Display Scale - Max. Value <input type="text" value="7525"/>	
Engineering Units			<input type="text" value="kFa/s"/>	
Decimal Position			###.# ▾	
Alarm Type			Disabled ▾	
Alarm Set-point 1 (S1 >= S2 Up Alarm; S1 < S2 Down Alarm)		<input type="text" value="0"/>		
Alarm Set-point 2 (S1 >= S2 Up Alarm; S1 < S2 Down Alarm)		<input type="text" value="0"/>		
Alarm Activation Delay Filter		<input type="text" value="0"/>		

Analogue input alarm configuration mask

- Maximum value of measuring electric scale (Hz): conversion parameter used to obtain the measurements from the frequency input (pulse input). This value represents the maximum frequency value the sensor can generate.
- Maximum value of displayed scale (expressed in the engineering unit specified above): Scaled value corresponding to the maximum value of the frequency signal.

Temperature ch.1	Temperature ch.2	Analogue Input	Pulse Rate Input	Error Management
Maximun Value of Measuring Electric Scale (Hz)			<input type="text" value="300.0"/>	
Maximun Value of Display Scale			<input type="text" value="30.0"/>	
Engineering Units			<input type="text"/>	
Decimal Position			#### ▾	
Alarm Type			Disabled ▾	
Alarm Set-point 1 (S1 >= S2 Up Alarm; S1 < S2 Down Alarm)		<input type="text" value="0.0"/>		
Alarm Set-point 2 (S1 >= S2 Up Alarm; S1 < S2 Down Alarm)		<input type="text" value="0.0"/>		
Alarm Activation Delay Filter		<input type="text" value="0"/>		

Pulse rate input (pulse input) alarm configuration mask

You can also set the activation of an alarm in case of errors in the operation of the module itself. Each alarm is associated with one or more error conditions on the module. You can associate the managed errors with an output to be activated. The list allowing to select the Output associated with the alarm shall include the output of the VMU-O modules existing in the group with the Alarm setting .

Temperature ch.1	Temperature ch.2	Analogue Input	Pulse Rate Input	Error Management
Error description: Error in the programmed parameters				<input type="text" value="No Alarm"/>
Error description: Short circuit on probe channel 1; Probe disconnected on channel 1; Short circuit on probe channel 2; Probe disconnected on channel 2				<input type="text" value="No Alarm"/>

Configuration mask for error management in case of error

3.4 VMU-O MODULE OUTPUT MANUAL COMMAND CONFIGURATION

Pressing the “NEXT” button again will grant access to the screen allowing to configure the manual commands of the relay outputs on the VMU-O modules .
Through this function, by using a manual command, you'll be able to remotely activate or deactivate (via Ethernet/through the Internet) the digital outputs of the VMU-O modules installed on-field.

Note: To be able to use this function, the outputs on the VMU-O modules must be set to REMOTE control.

Note: you can create up to 20 manual commands.

MANUAL SETUP

START > VMU-O > EM > VMU-P > > VMU-M > VMU-C > END

Back
Next

CONFIGURATION MANUAL COMMANDS FOR VMU-O MODULE

Commands 1-10 Commands 11-20

COMMAND	DESCRIPTION	BASE MODULE
1	<input type="text" value="Zot"/>	---
2	<input type="text" value="Opk"/>	VMU-C EM (Pos. 1 Ch 2)
3	<input type="text"/>	---
4	<input type="text"/>	---
5	<input type="text"/>	---
6	<input type="text"/>	---
7	<input type="text"/>	---
8	<input type="text"/>	---
9	<input type="text"/>	---
10	<input type="text"/>	---

VMU-O output manual command configuration mask

- In the “**Description**” column you can associate each command with a label identifying the function the command in question will activate (for example “Outdoor lighting switch-on”).
- The “**Base module**” column allows to associate the descriptive label (see the above paragraph) with the digital output defined for the purpose. Opening the drop-down menu will display the list of all the outputs previously set to REMOTE command .

3.5 CONFIGURATION OF THE VMU-M EM MODULES

Pressing the “NEXT” button again will grant access to the screen allowing to configure the VMU-M EM modules connected to VMU-C EM.

VMU-M module configuration mask

- Besides the label defined above, the top section displays the ModBus address for the specific VMU-M EM module.
- The bottom section is used for the configuration of the digital or temperature inputs and for other general alarms. Two sections are described below:

A. Inputs:

Define the use of the inputs existing on the VMU-M EM module:

- ⇒ NONE: the module inputs will have no use.
- ⇒ For TEMPERATURE reading (on one or two channels; probe type: Pt100 or Pt1000, 2 or 3 wires).
- ⇒ DIGITAL: digital input “1” shall be used to read the status (Open/Closed) of a digital contact (for example to detect whether the DC protection has tripped or not).

Note: when inputs are used for temperature reading, define whether you wish to manage the ALARM function for each channel.. In this case to set the values of “Threshold 1” and of “Threshold 2” (for values of “T1” exceeding or equal to those of “T2” you will get a MAXIMUM alarm; for values of “T1” lower than those of “T2” you will get an alarm with MINIMUM operation). You also have to define whether the alarm must be VIRTUAL or REAL (associated with a relay output of VMU-O).

B. Other alarms group:

Set the use of a further alarm managed by VMU-M EM

VMU-C

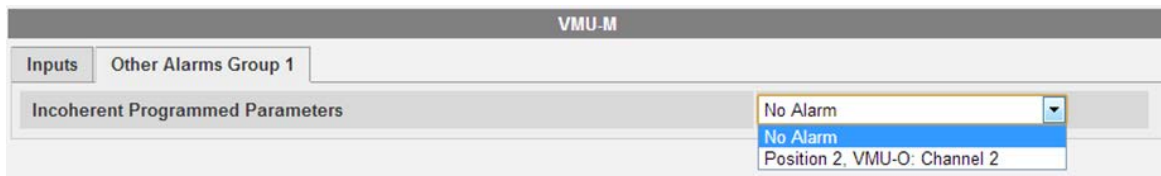

Other alarms group configuration mask

Note: should VMU-C EM find that the VMU-M EM programming is inconsistent with the modules connected to it, you may choose whether the error should not be managed or whether an alarm should be activated on a physical output.

Note: repeat the VMU-M EM MODULE CONFIGURATION procedure for each of the VMU-M EM modules connected to the VMU-C EM.

3.6 CONFIGURATION OF THE VMU-C EM MODULE

Pressing the “NEXT” button again will grant access to the screen allowing to fully configure the VMU-C EM module.

VMU-C EM configuration mask

The paragraphs below describe the individual pages allowing to configure the available functions:

- **GENERAL:** it allows to set a password whose function is protecting the device against unwanted configuration changes or reset commands.

Note: the password described above refers to all the VMU-M EM modules connected to the “COM1” communication port. It shall be identical and shared by all the connected VMU-M EM modules.

- **ENGINEERING UNIT:** it allows to set the engineering units for temperature measurements (°C or °F).

Engineering unit configuration mask

- **DATA LOGGING:** It allows to activate the Data Logging function and to define the relevant storage interval

Data logging time configuration mask

Note: available values for the storage interval range between 5 and 60 minutes. Intervals may be: 5min – 10min – 15min – 30min – 60 min.

VMU-C

- **OTHER ALARMS GROUP (VMU-C EM):** this section allows to configure the *Other general alarms* (Fig. 63):
 - *Communication Alarm on Port COM1 and/or COM2:* should a device connected to the COM1 and/or COM2 communication ports stop communicating for more the 30 sec. (if set), the system will trigger the alarm.

VMU-C			
General	Engineering Unit	Data Logging	Other Alarms Group
Communication Alarm on Port COM1 and/or COM2			Disabled ▼

Other alarms group configuration mask

Note: To be able to associate a physical output with these *Other alarms*, the VMU-O module must belong to the VMU-C EM group.

3.7 SENDING THE SYSTEM CONFIGURATION

Once system configuration is completed, the system will display the relevant screen (Fig. 64): all data can be loaded into the MASTER VMU-C EM module. Only after the user has issued the “Send plant data” command shall the data be operational.

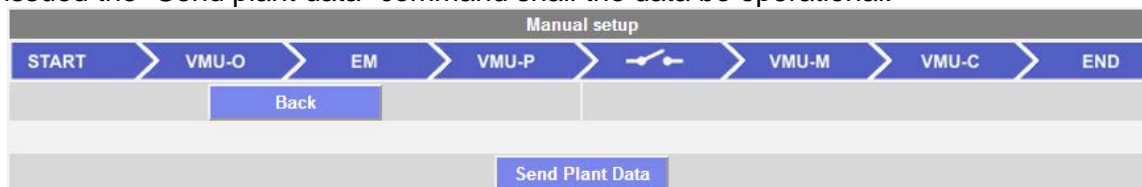

Configuration has been completed and is ready to be sent to VMU-C EM

While the configuration transfer is under way, the system will display the screen shown below:

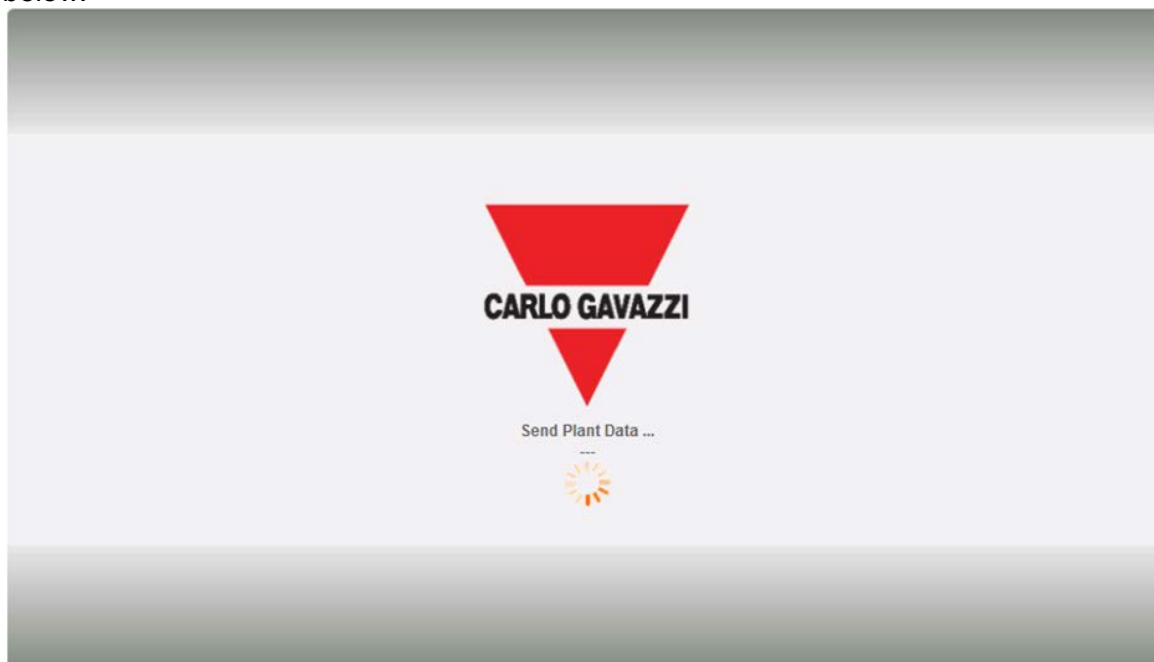

The configuration is being loaded into VMU-C EM

Once data transfer is completed the system will display a confirmation message. After having acknowledged by pushing the OK button, the user will be re-addressed to the Home Page

VMU-C

3.7.1 RESUME (SYSTEM) CONFIGURATION

If you exit the setup wizard before it is completed, you'll be able to resume the procedure through the “Resume configuration” command

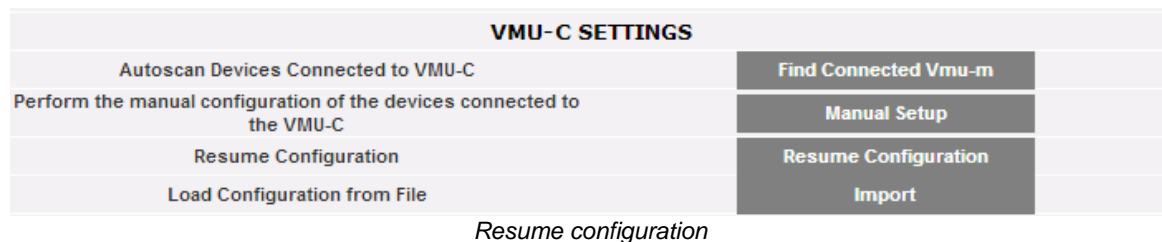

3.7.2 IMPORT (SYSTEM CONFIGURATION)

If the configuration of a plant has been exported using the “SAVE CONFIGURATION” command



you can import the configuration using the “IMPORT” command, then you can reload it into the same system or into a new one, thus avoiding having to re-enter all the configuration data.

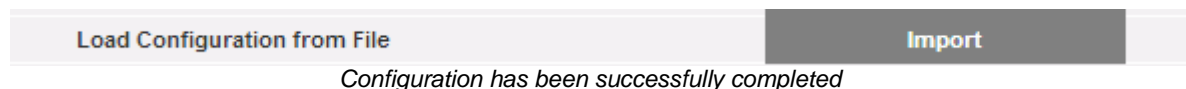

3.8 “OTHER VARIABLES” SETTING

When hovering the mouse over “OTHER VARIABLES” the system will display a drop-down menu showing the list of the variables which can be managed by VMU-C EM through the VMUP-EM module(s):

- ANALOGUE INPUT measurements (“mV” and/or “mA”); 1 channel
- TEMPERATURE measurements (from Pt100 and/or Pt1000, 2 or 3 wires); 2 channels
- Measurements from PULSE RATE INPUT (from pulse input for speed or flow measurements)

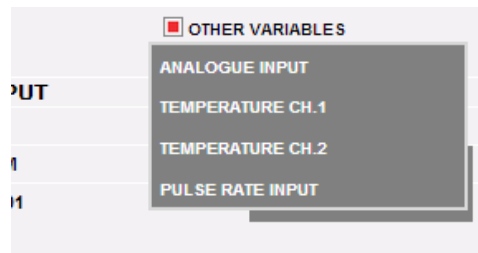

"Other variables" configuration

VMU-C EM can, through the VMUP-EM module, manage three different measurement types:

- Analogue output sensors, “120mV” and “20mA”
- Temperature sensors (Pt100 and Pt1000, 2/3 wires)
- Speed or flow measurement sensors

Clicking on one of the buttons corresponding to the individual types of managed sensors (Analogue, Temperature or frequency input), you can display more information about each sensor type:

ANALOGUE INPUT		
DESCRIPTION	VMU-M	
Analogue_Input	VMU-C EM	Details
Analogue_Input	VMU-M_001	Details

DETAILS		
Description	<input type="text" value="Analogue_Input"/>	
Address VMU-M	VMU-M_001	
Position VMU-P	1	
<input type="button" value="Save"/>	<input type="button" value="Reset"/>	<input type="button" value="Cancel"/>

You can define for each sensor a description which will help you identify, during reading, the sensor from which the measurement comes. The system will also display the following details:

- *VMU-M address* (or VMU-C address): ModBus address of the VMU-M or VMU-C module the sensor is connected to;
- *VMU-P position*: it indicates the position of the VMU-P module within the group;
- *Channel*: it indicates the position of the sensor inside the VMU-P module;

Press the “**Reset**” button to cancel the newly entered changes; you can also press “**Cancel**” to cancel the newly entered changes; unlike the “**Reset**”; with this operation the user shall exit the “Sensor details page”. Save the newly specified sensor settings by pressing the “Save” button.

4 HOME PAGE

Introduction

The HOME PAGE contents are selected by the user; the available options are:

- LOAD PROFILE
- TREND (It is a graph displaying a selection of multiple variables according to user selection. TREND creation is made in the PLANT menu; see the relevant section in this manual for further information)
- ENERGY SUMMARY (It displays Daily, Monthly, Yearly consumption data for an ordered list of meters (selected by the user). ENERGY SUMMARY configuration is made in the MONITOR menu; see the relevant section in this manual for further information)

4.1 Home Page – Load Profile

This selection is available to administrators by means of the SYSTEM/SETTING menu. Clicking on the “Home” icon in the Navigation menu will grant access to the screen showing the trend of power absorbed by the system during the current and the previous days, with a 5-minute sample resolution.

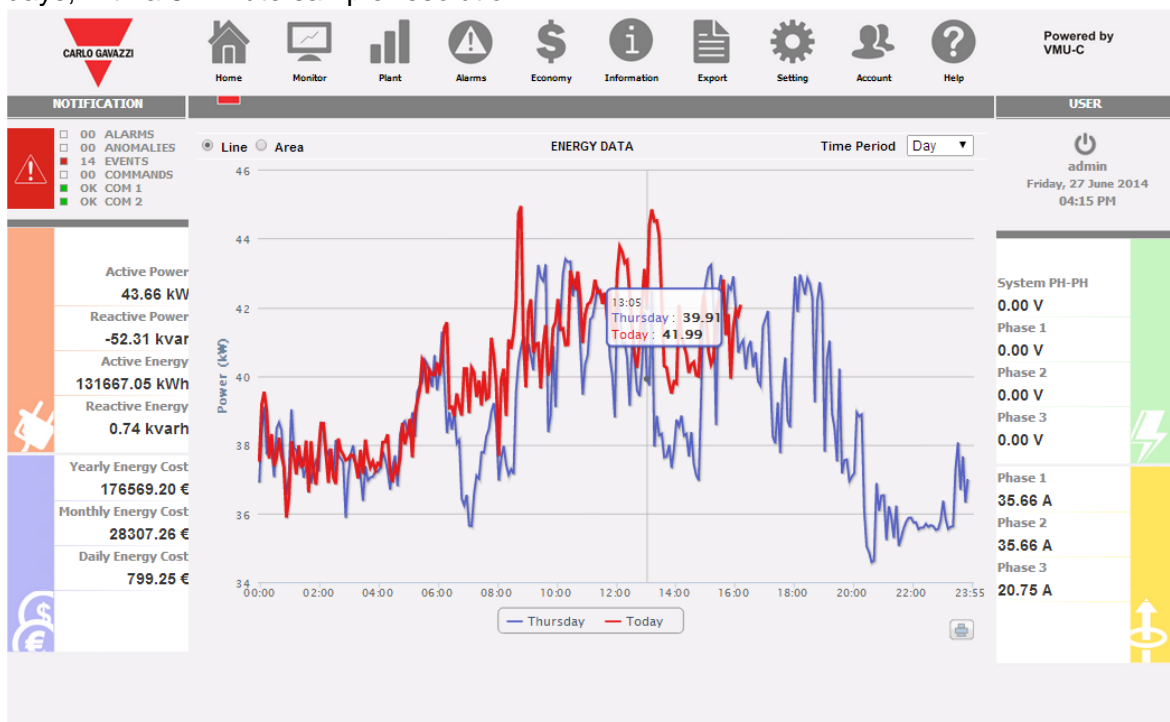

Home page

The chart can be displayed in “Line” or “Area” mode

On the abscissa axis the chart displays the hours of the day from 00:00 to 23:55, while on the ordinate axis it displays the power in kW; the maximum ordinate value is set automatically by an auto-range function.

The chart is automatically updated every 5 minutes. Hovering the mouse cursor over the chart area will display the relevant power value

You can also select 3 different chart types:

- *On a daily basis (DAY)*: the system displays the charts referring to the trend of the current day and of the previous one.
- *On a weekly basis (WEEK)*: the system displays the histograms referring to the trend of the current week and of the previous one (always from Monday to Sunday)
- *On a monthly basis (MONTH)*: the system displays the histograms referring to the trend of the current month and of the previous one (always from the first to the last day of the month)

- **Note:** for the daily chart you can choose between line or area display. Only histogram display is available for weekly and monthly charts.

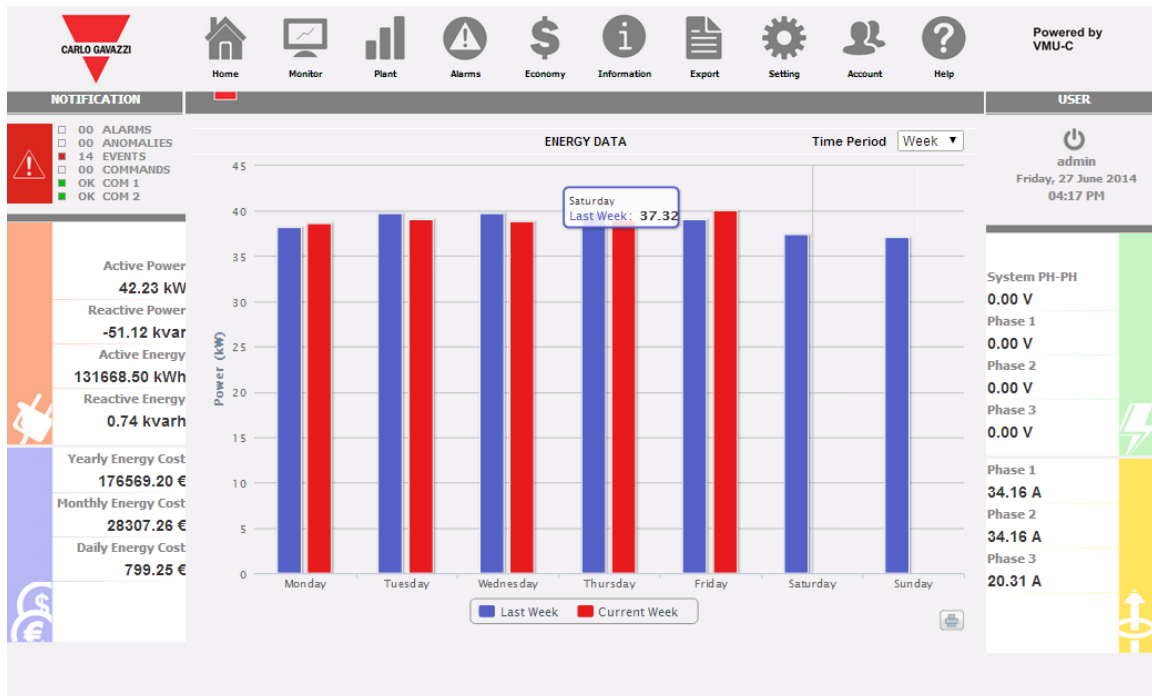

System weekly "AC" power

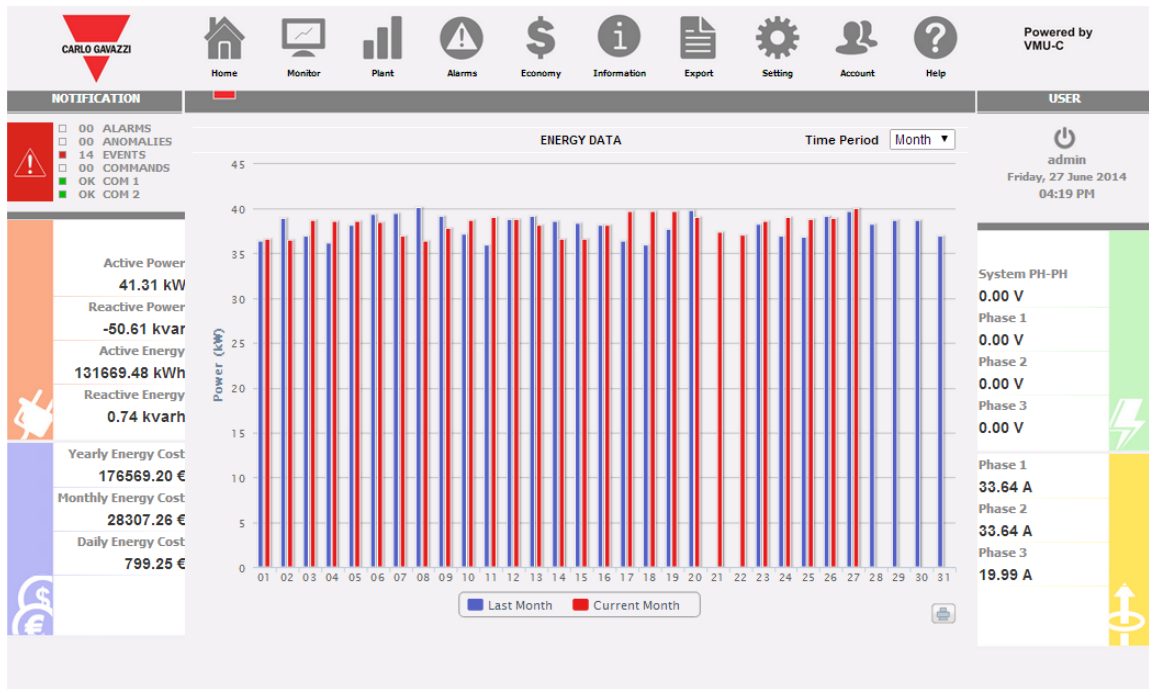

System Monthly "AC" power

- *Print chart*

By clicking on the Print button located in the lower right corner of the chart area, you can select which printer shall be used to print the chart.

5 MONITOR - METER DATA ANALYSIS

This section is devoted to the meter data analysis and allows to display in the main chart the trend of the main variables, like Current/Power Factor for each individual phase, System voltage (star and line), Power (active and reactive system power), analogue variables like Temperature, signal from pulse and analogue input (when available and anyway coming from VMU-P EM modules). Click on the “Monitor” icon in the Navigation menu to access the screen shown below:

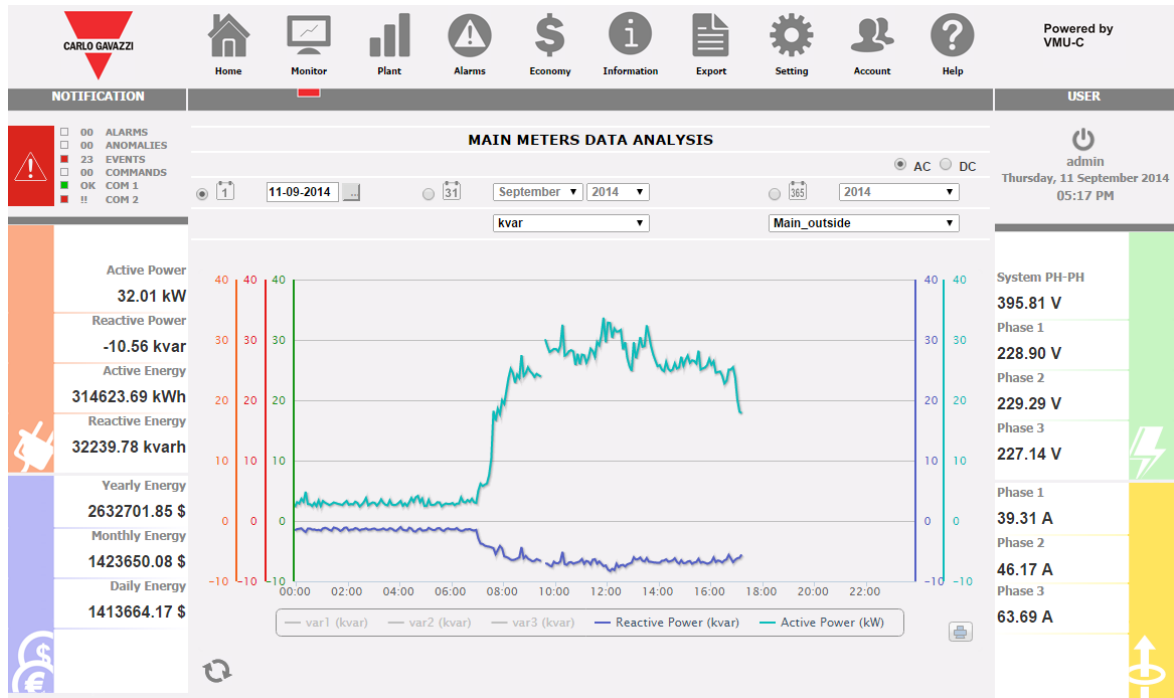

Production data analysis

It is possible to select both the target meter and the variables' trend; the available trends are:

Trend	Variables
A the VMU-C displays the three tracks referring to the three phase currents	AL1, AL2, AL3
PF,HZ the VMU-C displays the three tracks referring to the three individual phase power factors, and the system's PF and frequency	PF L1, PF L2, PF L3, PF Sys, Hz
VLL the VMU-C displays the tracks referring to the voltages (line to line voltages).	V12 V23 V31 VLL sys
VLN the VMU-C displays the tracks referring to the voltages (star voltages).	VL1N VL2N VL3N VLNsys
kW	kW1 kW2 kW3

Trend	Variables
	Active Power (system) Reactive power (System)
kvar	kvar1 Kvar2 kvar3 Active Power (system) Reactive power (System)
Analogue variables	VMU-P environmental variables (note that disconnected environmental channels are marked with an asterisk)

a) *Graphic functions*

Charts consist of an X-axis, showing day hours from 00:00 a.m. to 11:55 p.m., and of as many Y-axes as the number of dimensions to be shown. Each Y axis has a scale of its own, automatically sized according to the magnitude it refers to. To enable or disable (hide) a track, just click on the variable name (located under the X axis). The curve is displayed or removed right away, without having to refresh the page.

Hovering the mouse cursor over the chart area will open a window showing the numerical value of each displayed variable.

- *Print chart*

Clicking on the “Print” button located in the bottom right of the chart area you can specify which printer shall be used to print the chart .

b) Historical data analysis and graphic display

By means of the calendar tool it is possible to select the desired time interval to be displayed:

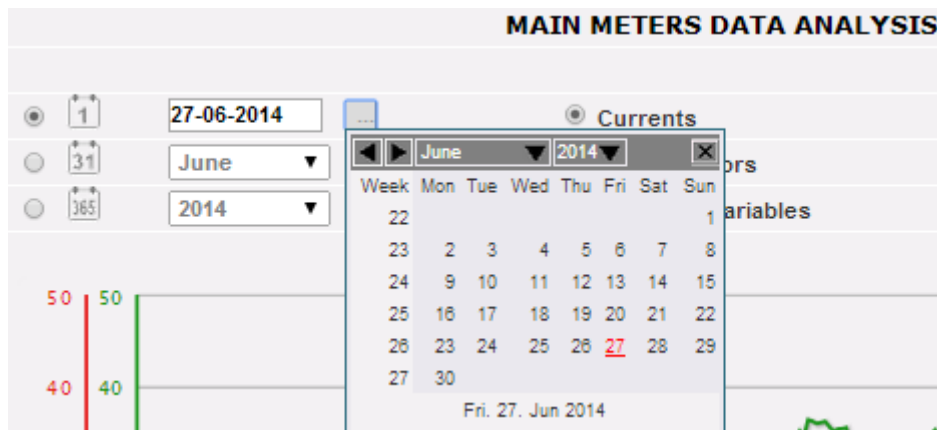

Date interval selection

Select the desired day and press “Refresh chart” button.

Note: the date field cannot be edited; date can only be selected through the relevant calendar.

VMU-C

Note: If chart is not displayed and a white area with the caption “No data to display” appears, it means that no data is available for the selected day.

5.1 “CURRENTS” CHART

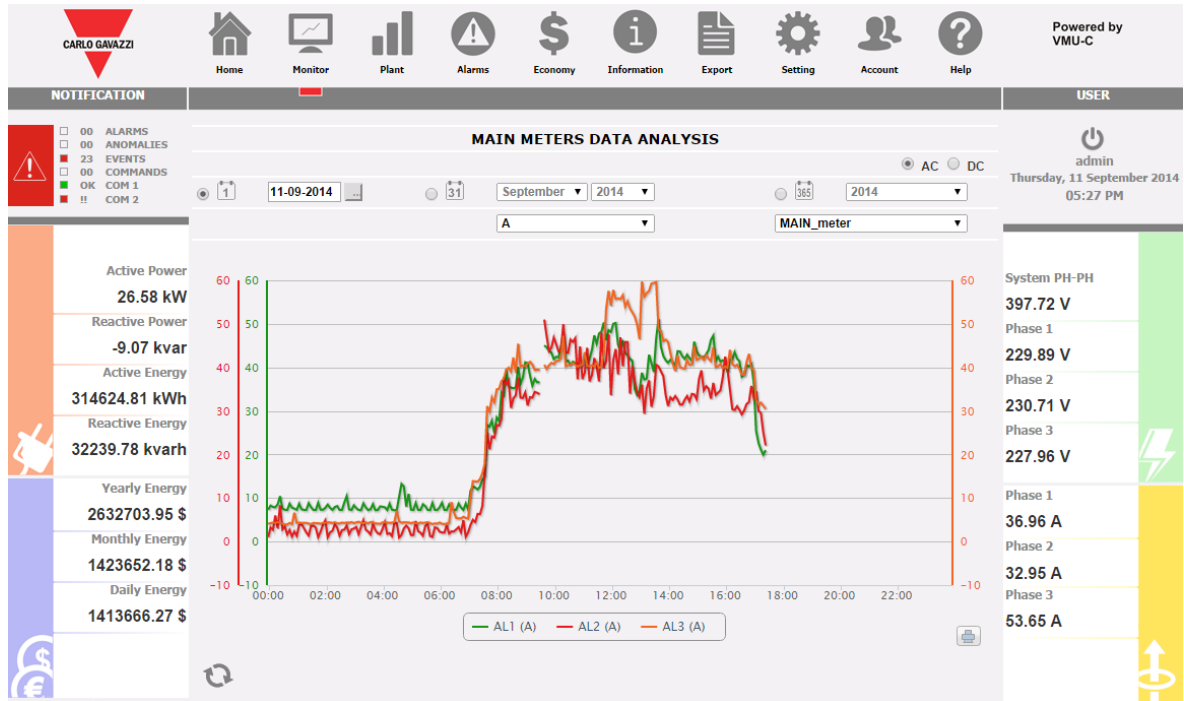

Main meter Currents chart (AL1, AL2 and AL3)

The chart displays the three phase currents. These currents refer to the instrument of choice (real or virtual according to the system configuration settings). Data may be displayed on a daily, monthly or yearly basis.

Note: in charts the sampling frequency (current values for each phase), depends on the storage interval set on VMU-C, which must be equal to 5,10,15,30,60 minutes.

5.2 “POWER FACTORS” CHART



Power factors chart (for each individual phase)

The Chart allows to compare the 3 individual phase Power Factors (PF1, PF2 and PF3), the system PF and frequency. These values refer to the instrument of choice (real or virtual according to the system configuration settings). Data may be displayed on a daily, monthly or yearly basis.

Note: in charts the sampling frequency (current values for each phase), depends on the storage interval set on VMU-C, which must be equal to 5,10,15,30,60 minutes.

5.3 "VOLTAGES" CHART

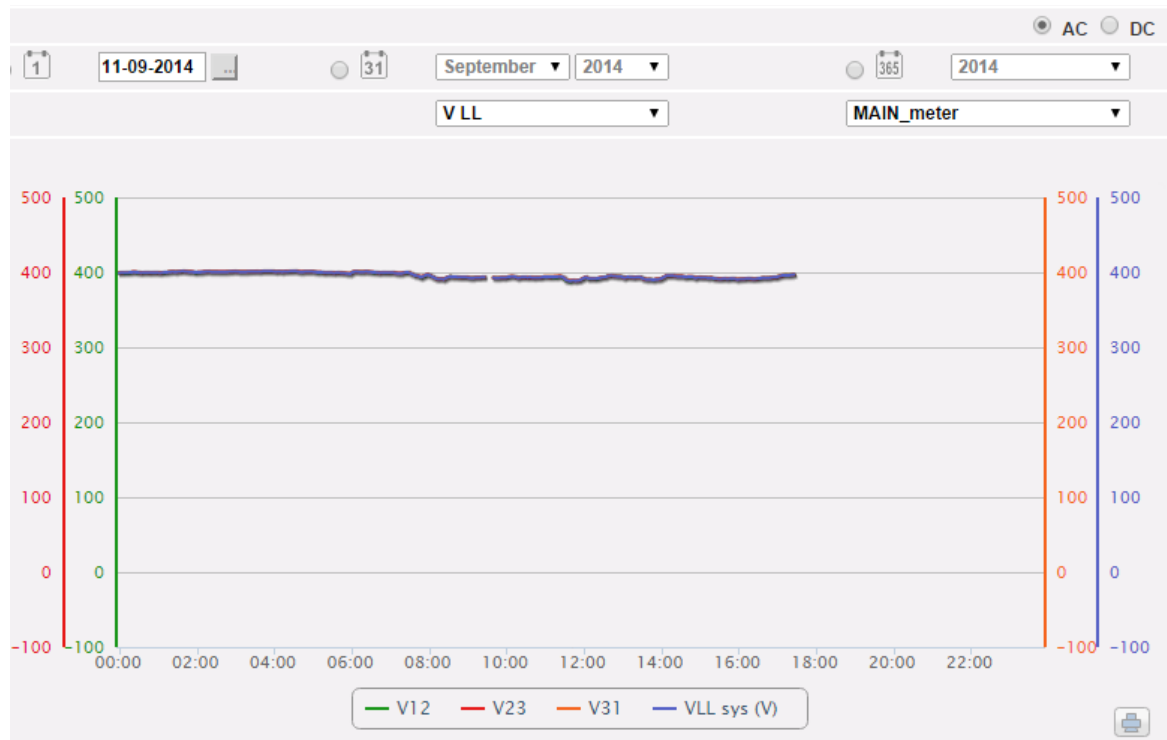

Voltage trend chart

The Chart compares the 2 voltage sets of data (VLNsys: star system voltage and VLLsys: line system voltage).

These values refer to the instrument of choice (real or virtual according to the system configuration settings).

Should the reference instrument be virtual, the voltages shown in the chart represent the average value of the voltages measured by each individual real instrument.

Data may be displayed on a daily, monthly or yearly basis.

Note: in charts the sampling frequency (current values for each phase), depends on the storage interval set on VMU-C, which must be equal to 5,10,15,30,60 minutes.

5.4 “POWER” CHART

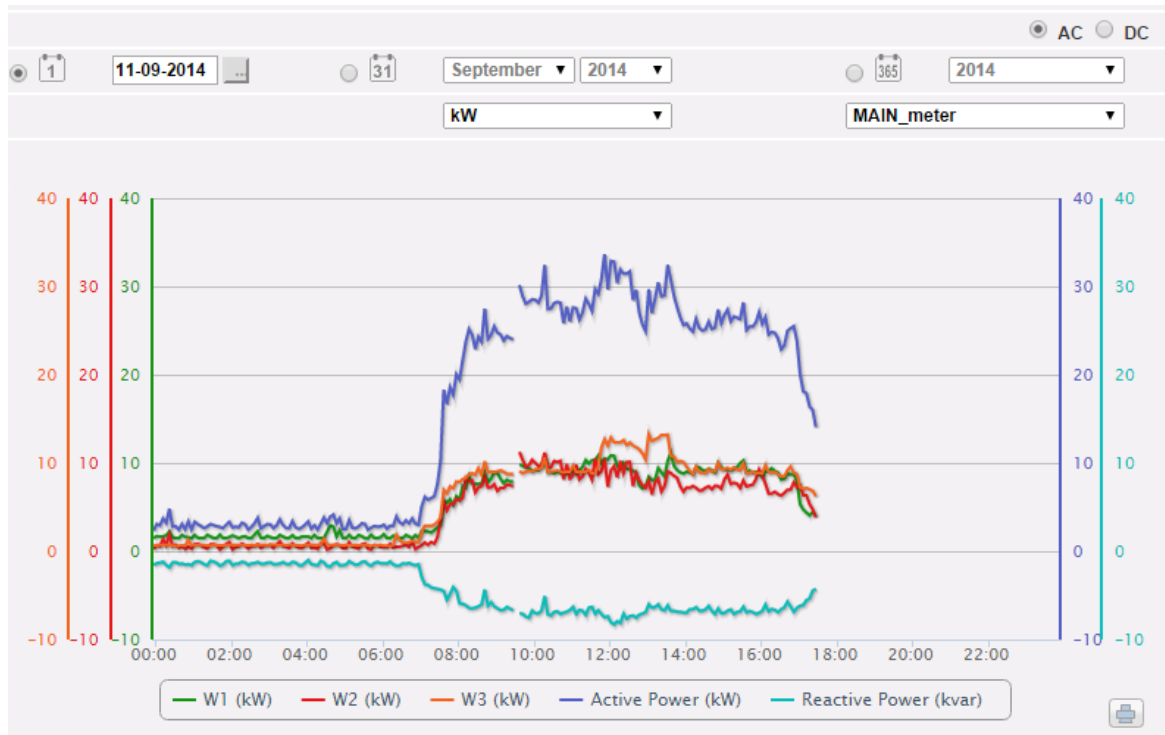

System power trend chart (kW and kvar)

The chart compares the 2 system power magnitudes (kW: active system power; kvar: reactive system power).

These values refer to the instrument of choice (real or virtual according to the system configuration settings).

Should the reference instrument be virtual, the powers shown in the chart represent the sum of the system powers (kW and kvar) measured by each individual real instrument.

Data may be displayed on a daily, monthly or yearly basis.

Note: in charts the sampling frequency (current values for each phase), depends on the storage interval set on VMU-C, which must be equal to 5,10,15,30,60 minutes.

5.5 “ANALOGUE VARIABLES” CHART

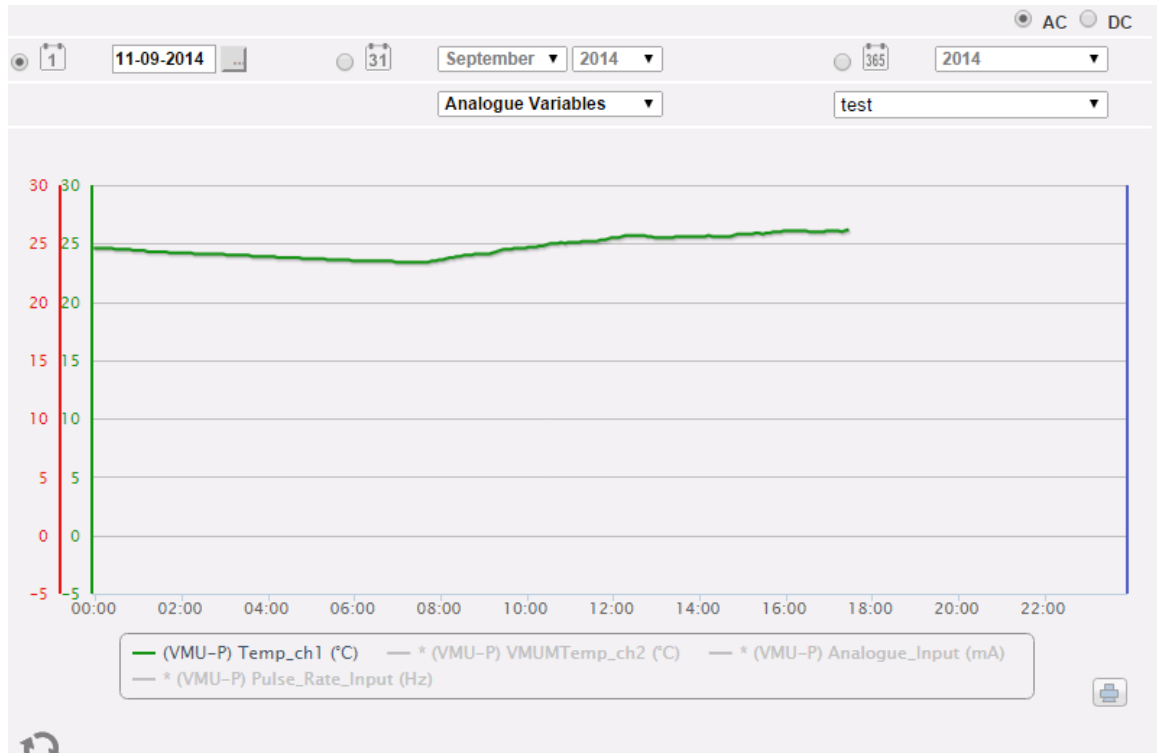

Analogue variables

By selecting “Analogue variables” you can display the 4 magnitudes listed below:

- a. “Temperature 1 (channel 1 of the VMUP) °C”
- b. “Temperature 2 (channel 2 of the VMUP) °C”

Note: these inputs (channel 1 and 2) for temperature measurement can read data from “Pt100” or “Pt1000” probes with 2 or 3 wires.

- c. “Pulse rate input (VMUP pulse input)”

Note: the pulse frequency input allows to measure a frequency signal for flow or speed measurements.

- d. “Analogue input (analogue input “mV” or “mA” of the VMUP)”

Note: the “mV” type analogue input is available on the module VMUP2TIWXSEM The “mA” type input is available on the module VMUP2TCWXSEM.

The box shown below allows to select the master to which the VMUP is connected: This selection allows to set whether the displayed variables belong to the VMU-P directly connected to the VMU-C EM or to one of the VMU-M EM connected by RS485 to the VMU-C EM itself. Variables relevant to disconnected sensors are marked with an asterisk and not shown by default.

VMU-C

Note: the sampling frequency in charts (analogue variables, temperature and pulse signal), depends on the storage interval set on VMU-C, which may be equal to 5,10,15,30,60 minutes.

5.6 DC MAIN METER CHARTS

By the selection AC/DC put on the top right of the page

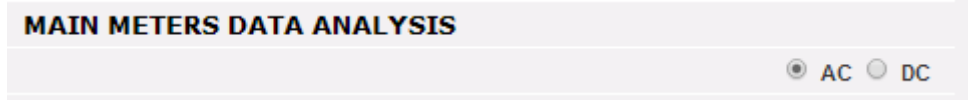

the display can be changed from the AC main meter (virtual or real) to the DC main meter (virtual or real).
In this case the only available graph compares the 3 DC main variables: voltage, current power.

5.7 Energy Summary

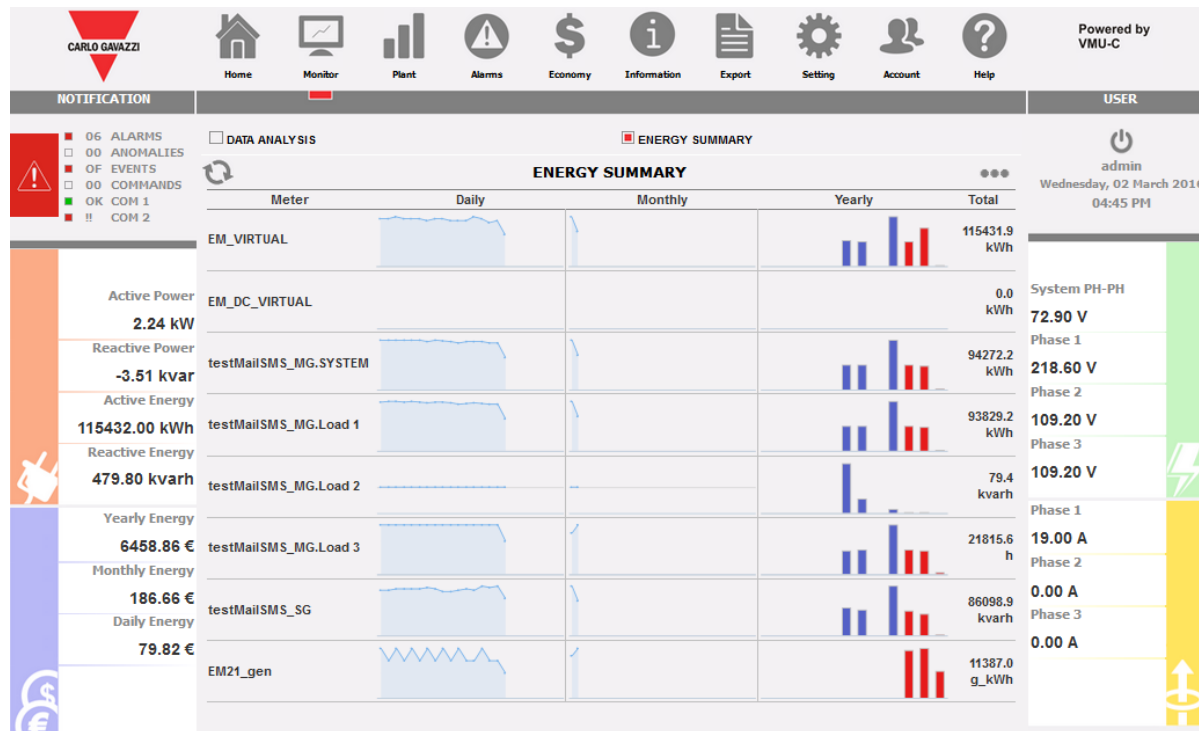

Energy Summary

This feature is available under the menu displayed in the above picture, in the MONITOR section.

It displays Daily, Monthly, Yearly consumption data for an ordered list of meters (selected by the user).

The available actions are:

Action	Interface control	Description
Refresh	Refresh control (on the top left side)	Refreshing the Energy Summary data
Layout selection	3-dots action menu	Selection of the desired layout; see the relevant section below

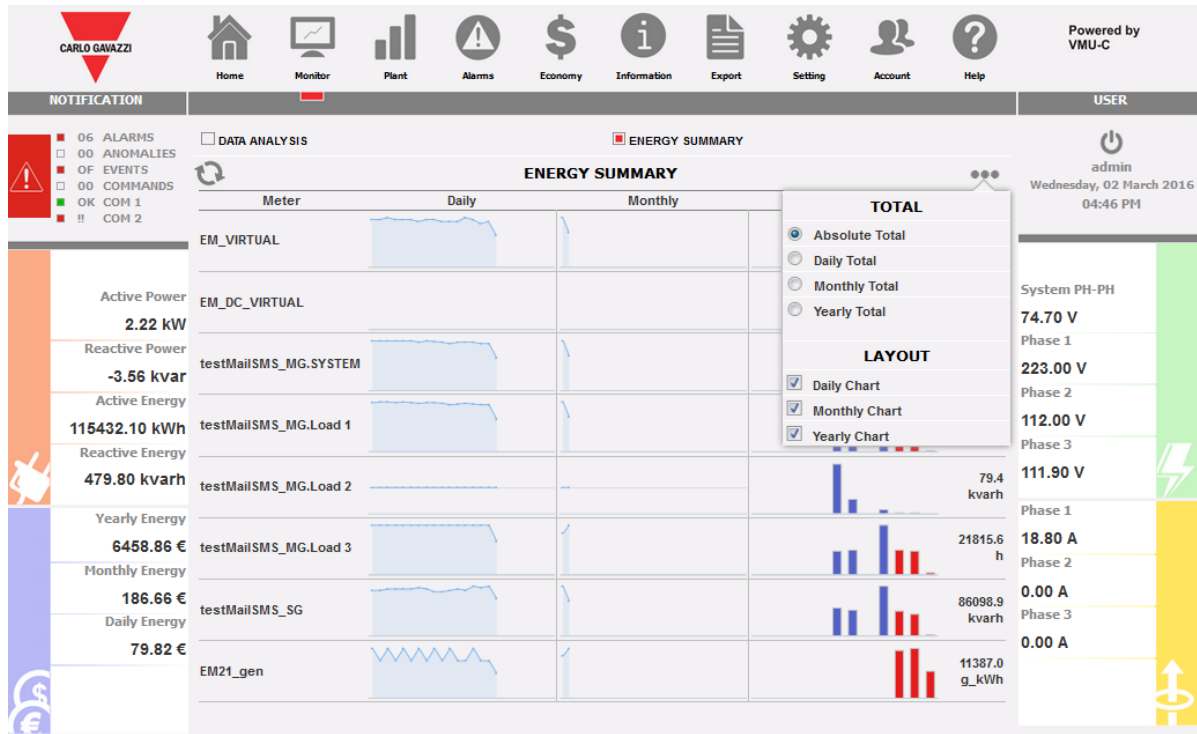

Energy Summary

The action menu includes:

Group	Description	Notes
TOTAL	Selecting the contents of the TOTAL column.	Available choices are: <ul style="list-style-type: none"> • ABSOLUTE TOTAL • DAILY TOTAL • MONTHLY TOTAL • YEARLY TOTAL
LAYOUT	Selecting the combination of charts to be displayed	This selection includes: <ul style="list-style-type: none"> • DAILY CHART • MONTHLY CHART • YEARLY CHART

Available charts:

Chart	Description	Notes
DAILY CHART	Energy consumption profile of the present day	
MONTHLY CHART	Energy consumption profile of the present month	
YEARLY CHART	Energy consumption profile of the last 12 months (1 bar each month). The calendar year split is represented by 2 different colors in the chart.	

5.7.1 Energy Summary configuration

Energy Summary configuration

The configuration of the ENERGY SUMMARY page is available under the ENERGY SUMMARY selection, in the MONITOR section.

By means of this page it is possible to:

1. Select the list of target meters of which displaying energy data
2. Select the target variables out of the list of the available variables in the target meter; only totalizing variables (i.e. kWh) are available in this section
3. Changing the engineering unit so as to align all the data to a common unit; a set of conversion scale factors is available, nonetheless the user is free to change the scale according to the needs
4. Changing the orders of the meters in the list; the order of choice is the one that will be displayed

The available actions are:

Action	Interface control	Description
SAVE	SAVE push button	Saving the present configuration

6 PLANT DATA CHARTS

This section displays in graphical form all the data acquired by VMU-C EM and read by the different devices (energy meters and VMU-P modules for analogue variables). Click on the “Plant” icon in the Navigation menu to access the following page :

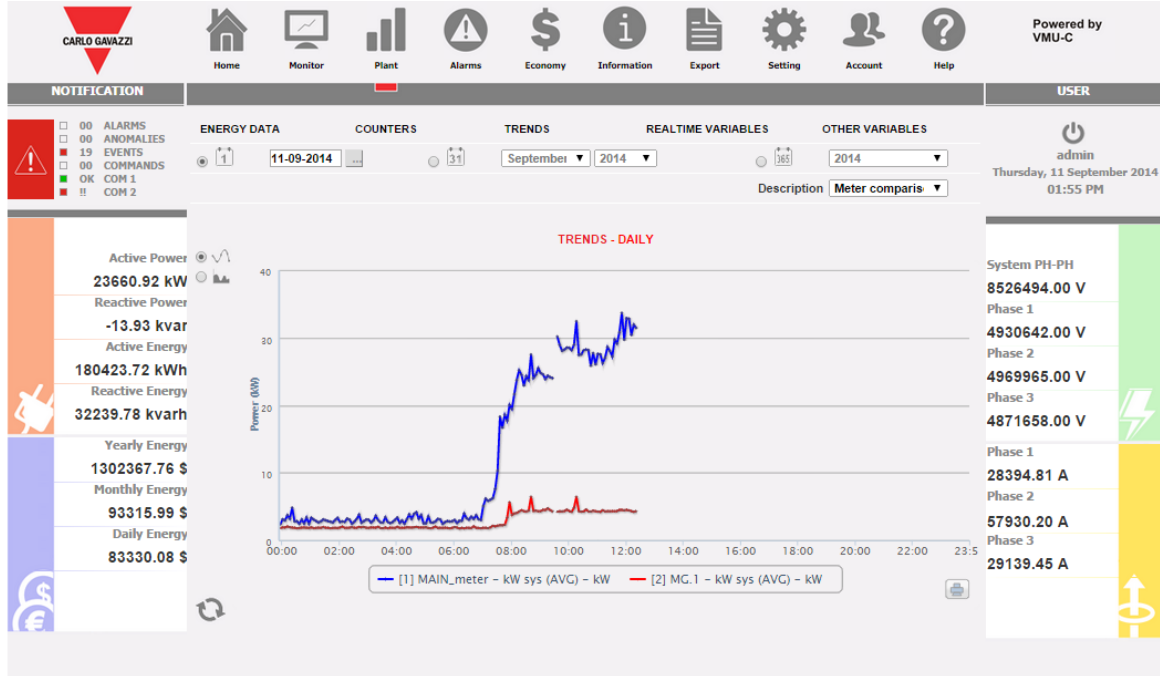

Production data charts

At the top there is the menu allowing to access the following sections:

1. **“ENERGY DATA”**: section devoted to the reading (in graphical form) of the energy and power value from the Energy Meters (EM).
2. **“COUNTERS”**: section devoted to the reading (in graphical form) of the values from external meters, like water meter, gas meter, etc, collected by the Energy Meters (EM) through pulse inputs.
3. **“REAL-TIME VARIABLES”**: section devoted to the real-time reading of the variables read through the Energy Meters (EM).
4. **“OTHER VARIABLES”**: section devoted to the reading (in graphical form) of the analogue values (temperature, speed/flow, generic from analogue input) read through the VMU-P EM modules.

6.1 ENERGY DATA

Hovering the mouse cursor over “ENERGY DATA” will display the items “MAIN METER AC”, “ENERGY METERS AC”, “MAIN METER DC”, “ENERGY METERS DC” .

6.1.1 MAIN METER

The power/energy curve represents the sum of all the contributions from the energy meters (EM), respectively AC or DC, monitored by the system in the selected time interval. In building this curve the system only takes into account the instrument which is identified as “*Main meter*”

If the “*Main meter*” is of virtual type (being the result of the contribution of multiple real instruments the displayed curve will be built as the sum of all the instruments whose contribution to the virtual instrument has been enabled.

Note: if no instrument has been set as “Main meter” and at the same time none of the installed instruments has been set to contribute to the virtual instrument, the page “Main meter” will include no chart.

Note: in charts the sampling frequency (for Power and Energy), depends on the storage interval set on VMU-C. It can be: 5,10,15,30,60 minutes.

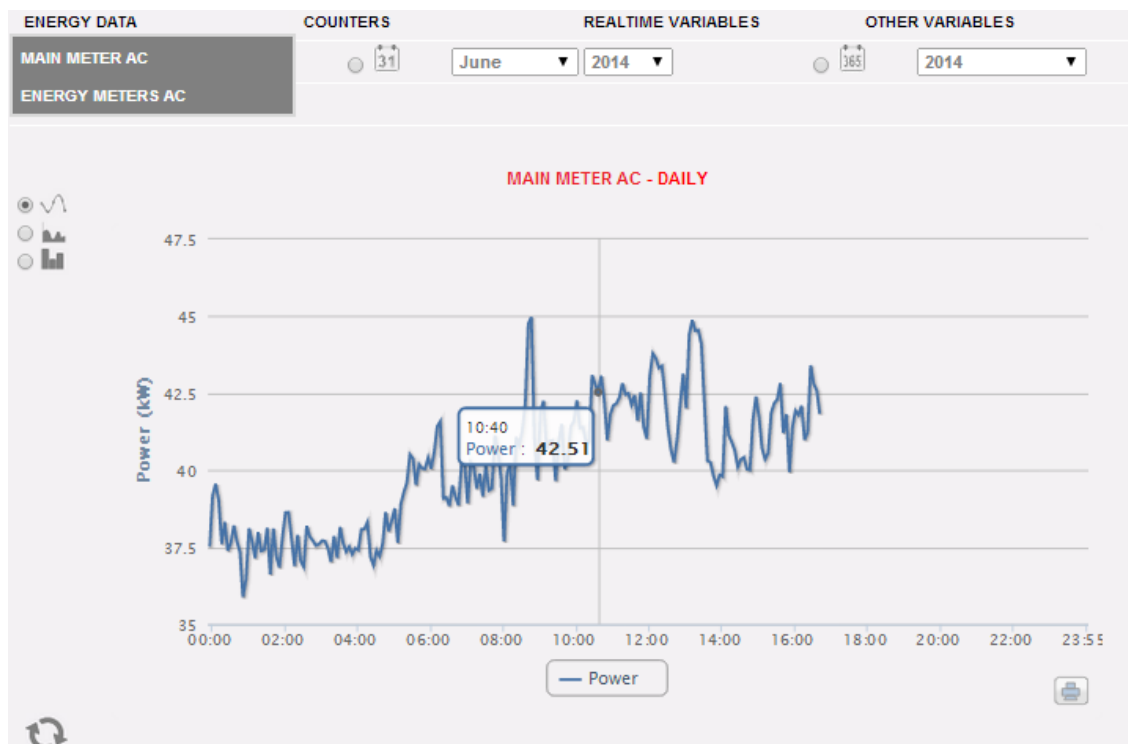

Main meter chart

This page consists of two sections:

Section A for search and selection (in the top section of the page) display type selection buttons:

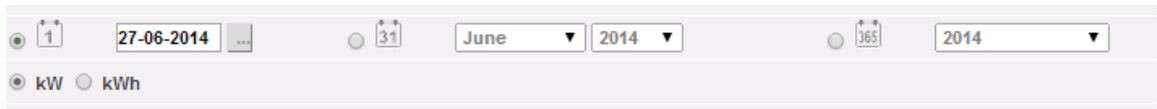

- **Daily:** it shows the daily trend of power or energy on the selected day. (To choose the day use the special calendar which can be accessed through the button next to the date field)
- **Monthly:** it shows the average daily power or the total measured energy, for each day of the selected month. To choose the month and year use the special selection menus next to the field.
- **Annual:** it shows the average monthly power or the total measured energy, for each month of the selected year. To choose the year use the special selection menu next to the field.

Note: only the line view is available for the daily Power and Energy charts. In the monthly and yearly view, the Power trend chart can be displayed both in line and bar (histogram) form; the energy chart can only be displayed in bar form (histograms).

Note: in daily charts the sampling frequency depends on the storage interval set on VMU-C. It can be: 5,10,15,30,60 minutes.

- The (A) section also includes the buttons allowing to select the variable to be displayed: Energy (kWh) or Power (kW).

Section B. On the abscissa axis (X) the chart displays time. The relevant resolution (hours, days, months) will depend on the selected view type (daily, monthly, yearly). On the ordinate axis(Y) the chart displays the power value in kW or the energy value in kWh, with an automatically sized scale (with auto-range function).

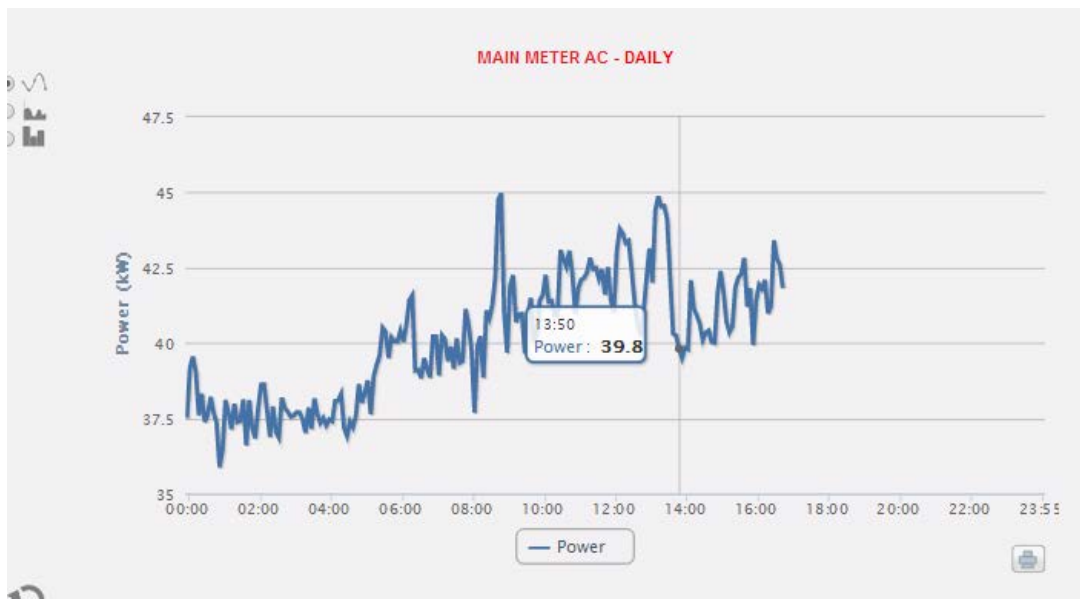

In the top left of this section there is a menu allowing to select the graphical display mode: "Line" (a continuous line) or "Bar" (for histograms).

Note: we recommend that you use the "Line" display for the daily Power data and the "Bar" mode (for histograms) for the monthly and yearly energy data.

- *Displaying a value in the chart*

Hovering the mouse cursor over the chart area will open a window with the relevant variable value .

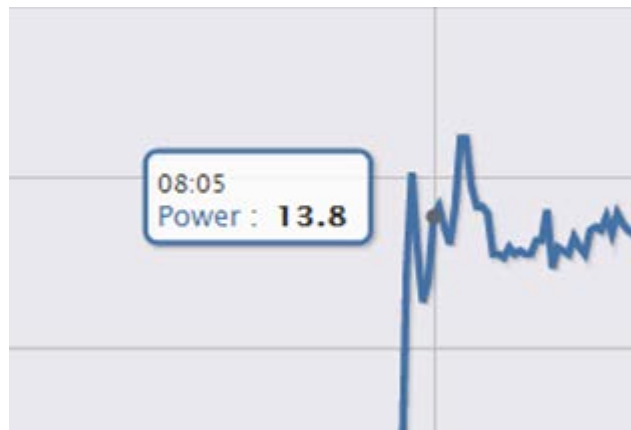

Displaying of a value

- *Print chart*

Clicking on the "Print" icon located in the bottom right corner of the chart area you can select the printer you wish to use.

6.1.2 ENERGY METERS (PARTIAL)

Hovering the mouse cursor on “ENERGY DATA” and selecting the “ENERGY METERS” item will grant access to a window displaying the daily trend of the power measured by each energy meter of the plant. Each curve has a different colour and can be identified by the legend on chart bottom. Use the “Energy meter name” menu to display the production curve of a specific instrument, as well.

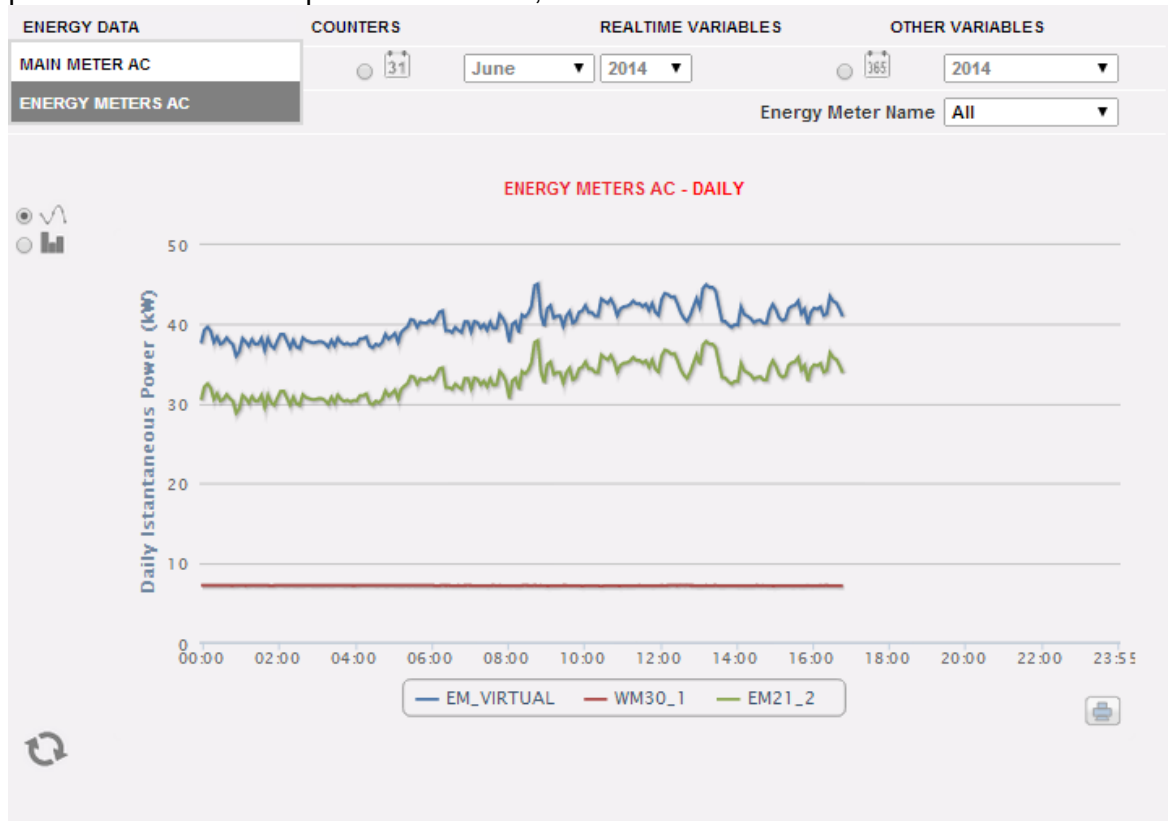

ENERGY METERS – PARTIAL METERS chart

This page is divided into two sections:

A. **Section A**, for search and selection (on the TOP)

It allows to select the display type, using the dark grey buttons:

- **Daily:** daily trend of power or energy on the selected day. To select the day use the calendar, which can be accessed by pressing the button next to the date field.
- **Monthly:** average daily power or total produced energy, for each day of the selected month. To select the day use the calendar, which can be accessed by pressing the button next to the date field.
- **Annual:** average daily power or total produced energy, for each month of the selected year. To select the day use the calendar, which can be accessed by pressing the button next to the date field.

After selecting the display type press the “*Refresh Chart*” button.

The light grey buttons on the left you can select the type of magnitude to be shown: **Power** or **Energy**.

The energy meter selection menu is displayed in light grey. The list contains:

- The list of all the names assigned to the energy meters included in VMU-C EM; when selecting an individual meter, only the relevant curve will be displayed.
- The “ALL” item, allowing to simultaneously display all the energy meters configured and existing in the plant.
- The “EM_VIRTUAL” item displays the data associated with the virtual instrument, which, depending on the configuration page settings, represents the sum of two or more real instruments (or anyway of all the instruments for which the check box “contribution to the virtual instrument” has been enabled).

Note: comparing the trends of the measurements of the different energy meters allows to easily identify any anomalies in the consumptions of the individual plant instruments.

Note: all keys and selections outside the dark grey area do not need the “Refresh chart” function. After a few moments the chart will refresh automatically.

B. “Section B” contains the charts (on the BOTTOM)

On the abscissa axis (X) the chart displays the time references; the resolution (hours, days, months) depends on the selected display type (daily, monthly, yearly). On the ordinate axis (Y) the chart displays the power value in kW or the energy value in kWh, with an automatically sized scale (with auto-range function).

In the top left of this section there is a menu allowing to select the graphical display mode: “Line” (a continuous line) or “Bar” (for histograms).

On the abscissa axis (X) the chart displays time; the resolution (hours, days, months) depends on the selected display type (daily, monthly, yearly). On the ordinate axis (Y) the chart displays power in kW or energy in kWh, with a scale automatically sized according to the plant peak power.

Note: we recommend that you use the “Line” or “Area” display for the daily Power data and the “Bar” display (for histograms) for the monthly and yearly energy data.

6.2 COUNTERS (GENERIC FROM DIGITAL INPUTS)

Hovering the mouse cursor on “COUNTERS” and then clicking on the “ENERGY METERS” item will grant access to the generic meter screen (counting the pulses collected by the digital inputs of the Energy meters installed on the system, Fig. 98).



Generic counter (H2O, GAS, ...) access selection

As soon as the user accesses the page, the system displays the daily trend of the monitored meters installed in the specific plant. To simplify the identification of each individual track, every individual curve/line has a different colour and can be identified through the legend in the bottom section of the chart. The “Description” menu allows to select and display the meter trend from the specific instruments.

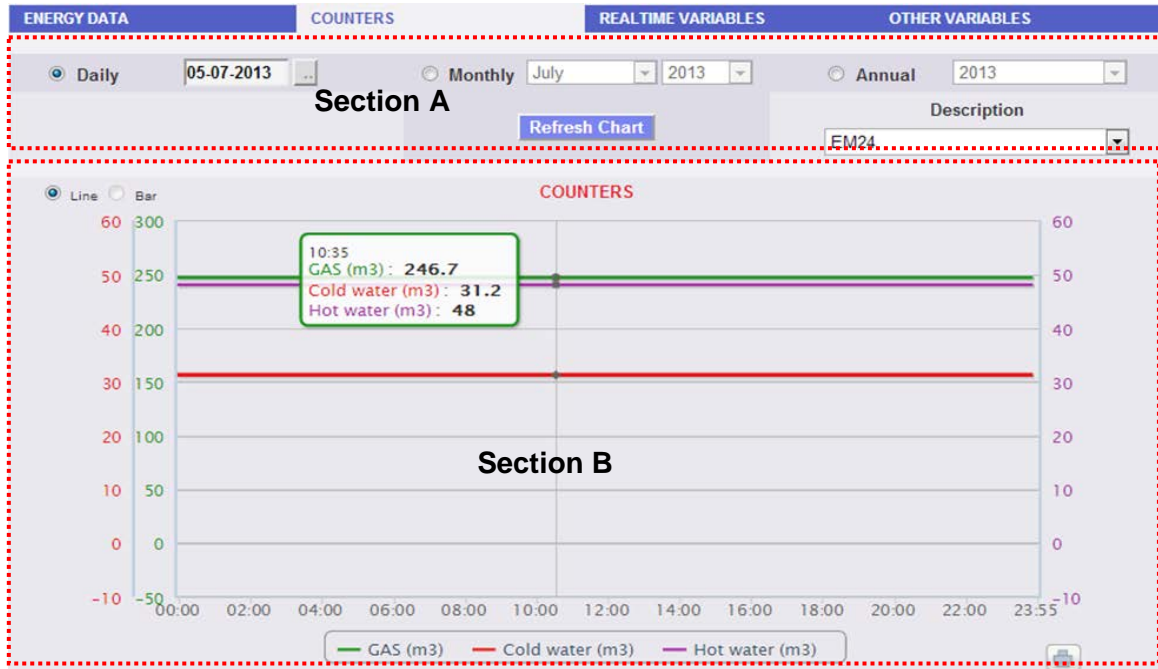

Fig. 99 – Generic meters (H2O, GAS, ...)

This page consists of two sections:

"Section A" for search and selection (in the top section of the page)

It allows to select the display type, using the dark grey buttons:

- **Daily:** it displays the daily trend of the meters for the selected day. To choose the day use the special calendar which can be accessed through the button next to the date field.
- **Monthly:** it displays the daily average of the meters, for each day of the selected month. To choose the month and year use the special selection menus next to the field.
- **Annual:** it displays the meter trend (on a monthly basis) for each month of the selected year. To choose the year use the special selection menu next to the field.

After selecting the display type press the “Refresh Chart” button.

On the right there is a menu allowing to select the Energy Meter the digital inputs refer to. The list includes all the instruments, with the enabled meters from digital instruments.

Note: all keys and selections outside the dark grey area do not need the “Refresh chart” function. After a few moments the chart will refresh automatically.

- C. “Section B”, displaying in graphical form the trend of the different meters from the digital inputs.

On the abscissa axis (X) the chart displays the time references; the relevant resolution (hours, days, months) depends on the selected display type (daily, monthly, annual). On the ordinate axis (Y) the chart displays the numerical references (automatically scaled) for each meter.

For this type of view only the “Line” track is available (the “bar” button is not enabled).

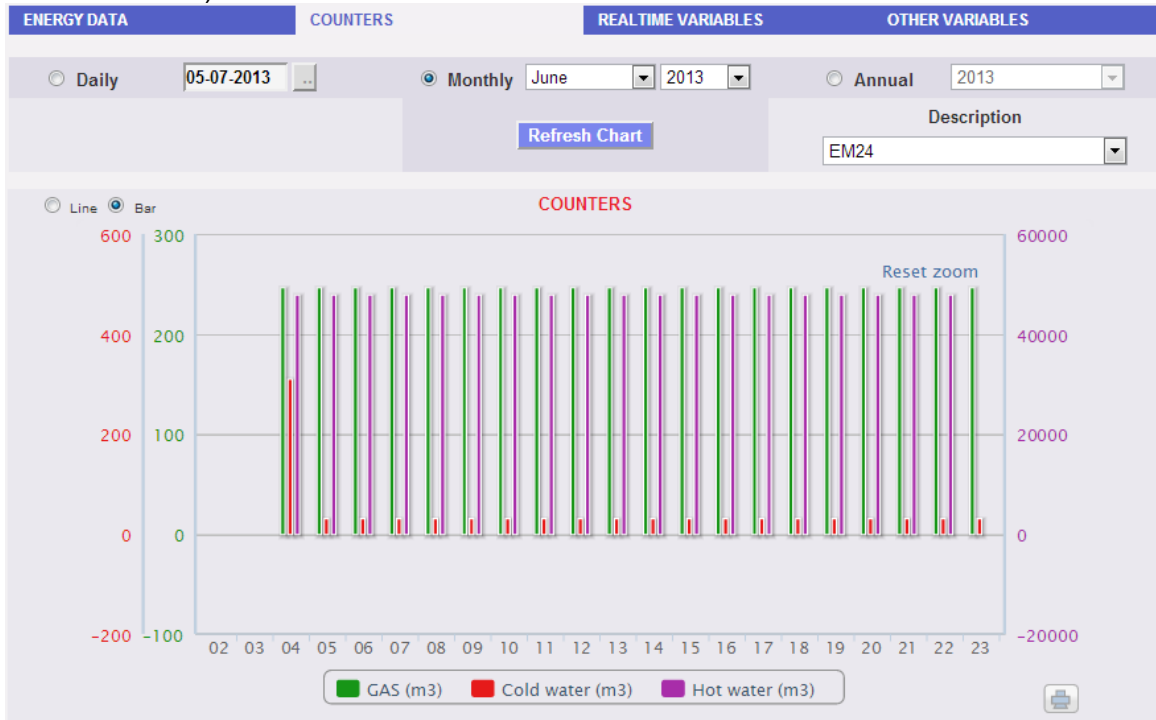

Generic meters (H2O, GAS, ...) - monthly display

Note: for monthly and yearly data we recommend that you use the “Bar” display (for histograms).

6.3 TRENDS

6.3.1 Trends Editing

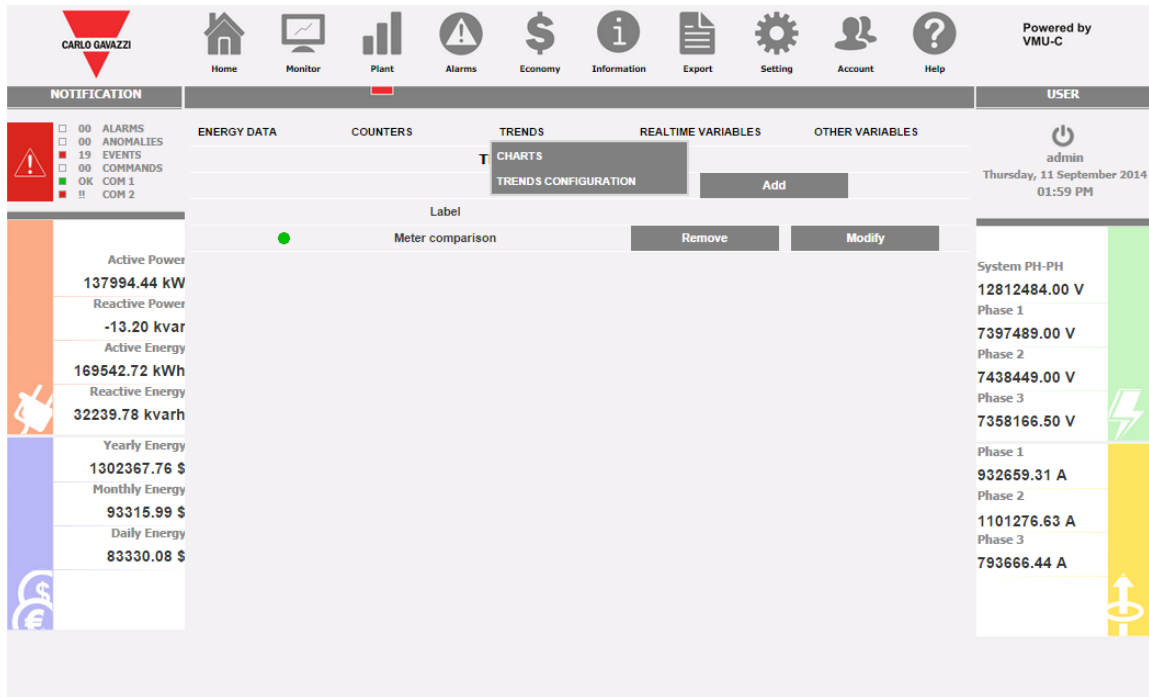

Customized trends management page

By means of the “TREND” submenu it is possible to create and save customized trends of groups of variables chosen from the available set. Any mix of variables from any energy meter or VMU-P module may be chosen.

By the “TRENDS CONFIGURATION” page it is possible to:

Function	How to
Add new trends	By means of the “Add” button
Remove an existing trend	By means of the “Remove” button
Modify an existing trend’s settings	By means of the “Modify” button

Customized trends management page - Modify

By the “Modify” page it is possible to:

Function	How to
Add a new Name to the customized trend	By means of the “Label” field
Select an Instrument	By means of the “Instrument” drop-down list (Disabled instrument are marked with an asterisk)
Select a module (relevant to the instrument of choice)	By means of the “Module” drop-down list (i.e. it is possible to select a VMU-P module from a VMU-C instrument)
Select a variable (relevant to the instrument and module of choice)	By means of the “Variables” drop-down list The following variables’ types are marked with an asterisk: <ul style="list-style-type: none"> • Variables of disabled instruments • Variables not available (i.e. temperatures from VMU-P modules without temperature sensors physically connected)
Select the type of the trend, chosen by average, maximum, minimum values	By means of the “Type” drop-down list
Selecting the color of the trend	By means of the relevant color selection control
Add notes	By means of the “Notes” field

By pushing “Save” it is possible to store the trend

6.3.2 Trends Displaying

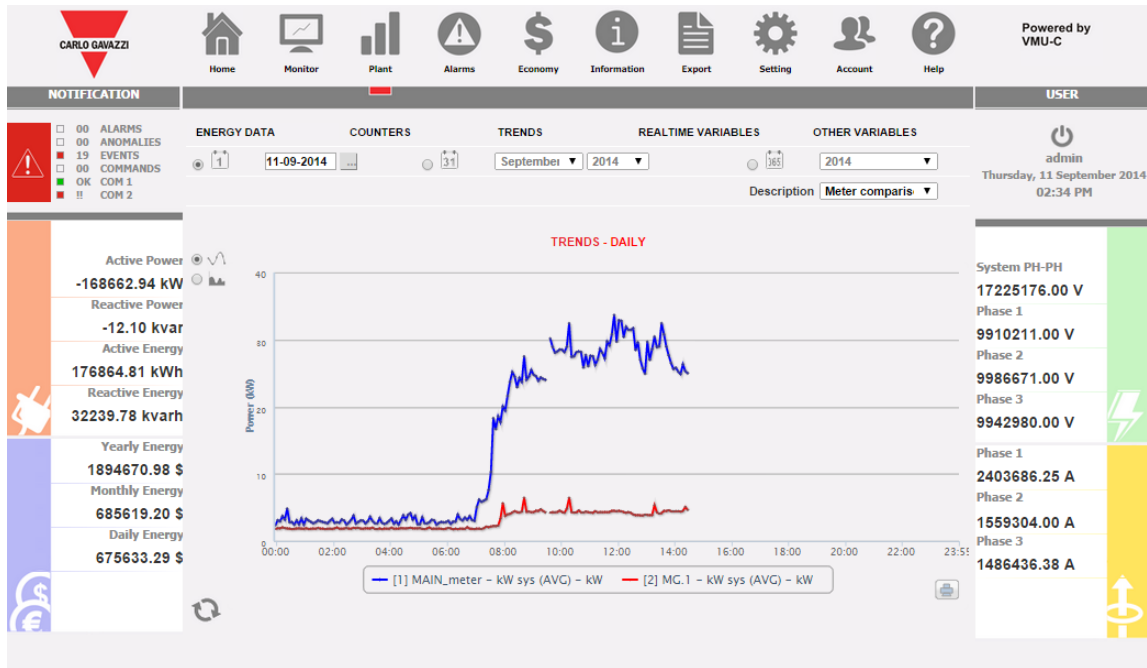

Customized trends management page - CHARTS

By choosing CHARTS in the TRENDS menu it is possible to display the trend of choice. Trend selection is made by the DESCRIPTION drop-down list

6.4 REAL TIME VARIABLES

Hovering the mouse cursor over “REALTIME VARIABLES” and then over “ENERGY METERS AC” or “ENERGY METERS DC” will grant access to the following screen:

Page for real-time variable reading

Section A				
ENERGY DATA	COUNTERS	TRENDS	REALTIME VARIABLES	OTHER VARIABLES
Energy Meter Name		MAIN_meter		Refresh Time
				10 s
Realtime Readings		System	L1 (A)	L2 (B)
Active Power (kW)		27.63	10.47	7.58
Reactive Power (kvar)		-7.14	-2.77	-2.48
Apparent Power (kVA)		28.74	10.90	7.98
Power Factor		0.96	0.96	0.95
Frequency (Hz)		50.0		
			L3 (C)	
Current (A)			48.04	34.84
Phase-phase Voltage (V)		392.98	392.60	393.16
Phase-to-neutral Voltage (V)		226.79	225.75	228.31
Imported (Exported) Active Energy (kWh)		36961.6		
Imported (Exported) Reactive Energy (kvarh)		2290.7		
THD Current (%)			13.50	19.51
THD Voltage (%)			3.26	3.15

Section B

This page consists of two sections:

- A. “Section A”, on the TOP, allowing to make searches and to select the refresh time.
- **Energy meter name:** select the instrument from which you wish to read the variables in real time.
 - **Refresh time:** select the refresh time for the displayed data (5, 10, 30 or 60 seconds).
- B. “Section B”, on the BOTTOM, displaying all the values refreshed according to the interval selected above. In case of DC energy meter, the available set of variables is limited to current, voltage, power and DC energy.

Note: The “Energy meter name” item allow to select a different instrument through the drop-down menu; the relevant data will then be immediately updated.

6.5 OTHER VARIABLES

Hovering the mouse cursor over “OTHER VARIABLES” will display the following screen:

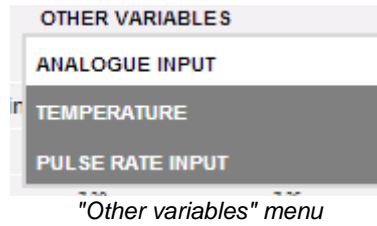

6.5.1 ANALOGUE INPUT

As soon as the user accesses the “ANALOGUE INPUT” page, the system will display the data from the VMU-P EM modules, and more precisely from the “mV” or “mA” inputs of the module itself.

Accessing this page will display the daily trend of the variable monitored by the above-mentioned analogue input.

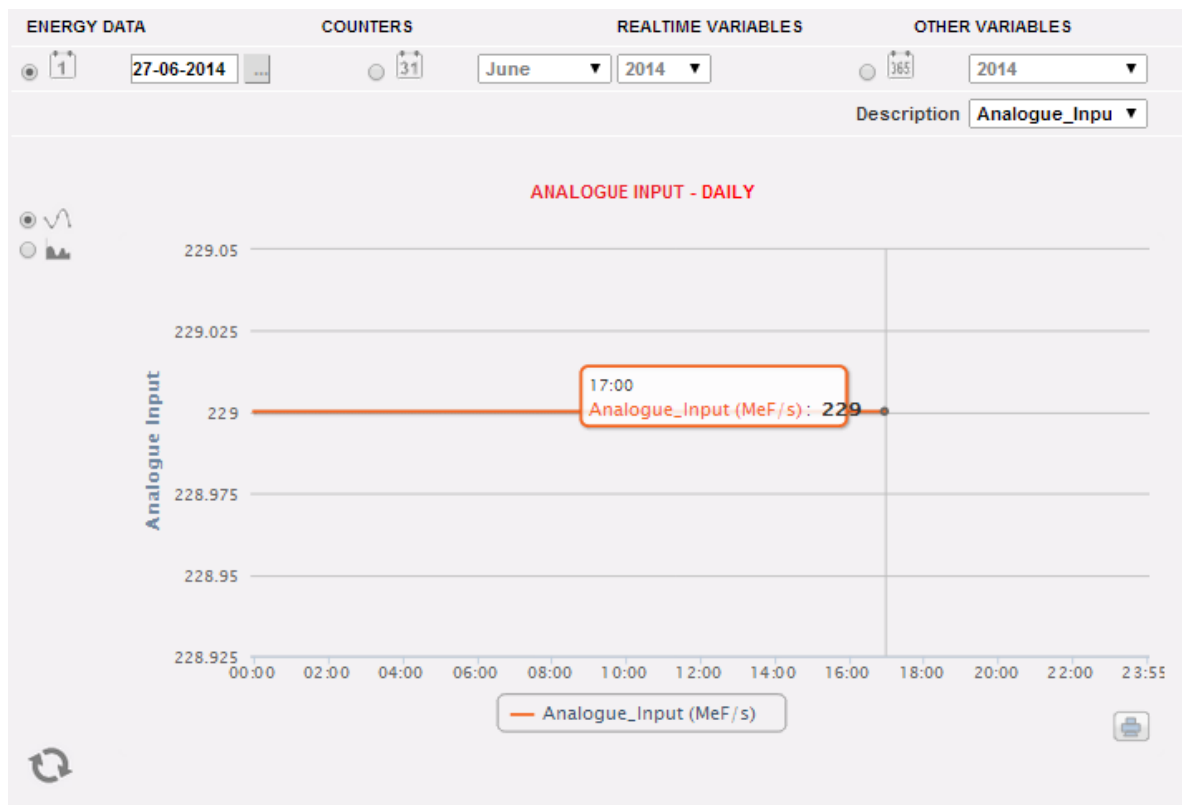

Analogue input variable trend

This page consists of two sections:

"Section A" for search and selection (in the top section of the page).

It allows to select the display type, using the dark grey buttons:

- **Daily:** it displays the daily trend of the variable for the selected day. To choose the day use the special calendar which can be accessed through the button next to the date field.
- **Monthly:** it displays the daily average of the value monitored by the analogue input, for every day of the selected month. To choose the month and year use the special selection menus next to the field.
- **Annual:** it displays the trend of the average (monthly) value monitored by the analogue input, for each month of the selected year. To choose the year use the special selection menu next to the field.

After selecting the display type press the “Refresh Chart” button.

On the right there is the menu allowing to select the analogue input. The list shall include all enabled analogue inputs.

Note: all keys and selections outside the dark grey area do not need the “Refresh chart” function. After a few moments the chart will refresh automatically.

- D. **“Section B”** displays in graphical form the trend of the selected variable, (in the bottom section of the page).

On the ordinate axis (Y) the chart shows the scaled value for the monitored value (with auto-range function).

Two display types are available: “Line” track or “Area” track.

Note: in daily charts the sampling frequency depends on the storage interval set on VMU-C EM; it can be: 5,10,15,30,60 minutes.

6.5.2 TEMPERATURE

As soon as the user accesses the “TEMPERATURE” page, the system displays the data coming from the VMU-P EM modules, and more precisely from the inputs for temperature measurement (from Pt100 and/or Pt1000) of the module itself.

Accessing this page will display the daily trend of the variable monitored by the above-mentioned analogue input.

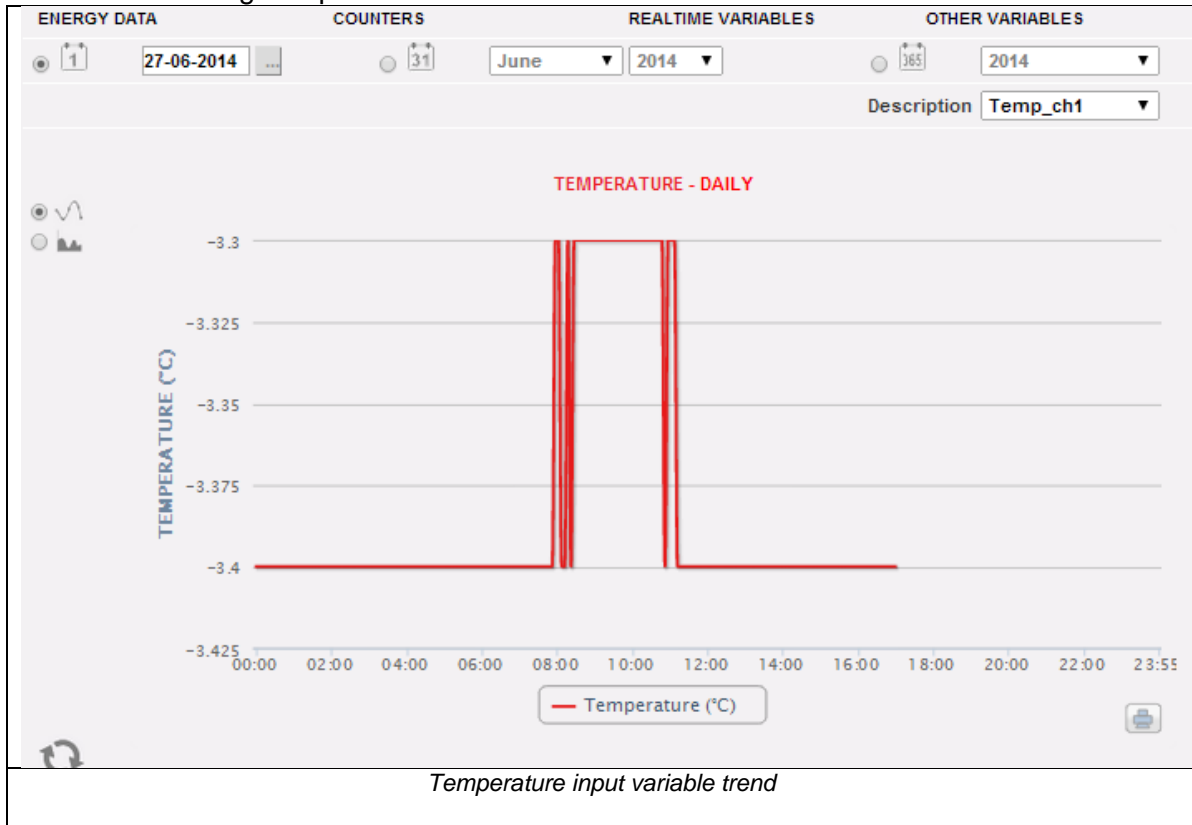

This page consists of two sections:

"Section A" for search and selection (in the top section of the page)

It allows to select the display type, using the dark grey buttons:

- **Daily:** it displays the daily trend of the variable for the selected day. To choose the day use the special calendar which can be accessed through the button next to the date field.
- **Monthly:** it displays the daily average of the value monitored by the temperature input, for every day of the selected month. To choose the month and year use the special selection menus next to the field.
- **Annual:** it displays the trend of the average (monthly) value monitored by the temperature input, for each month of the selected year. To choose the year use the special selection menu next to the field.

After selecting the display type press the “Refresh Chart” button.

On the right there is the menu allowing to select the temperature input. The list shall include all enabled inputs.

Note: all keys and selections outside the dark grey area do not need the “Refresh chart” function. After a few moments the chart will refresh automatically.

- E. **“Section B”** (on the bottom) displays in graphical form the trend of the selected variable.

On the ordinate axis (Y) the chart shows the scaled value for the monitored value (with auto-range function).

Two display types are available: “Line” track or “Area” track.

Note: in daily charts the sampling frequency depends on the storage interval set on VMU-C EM. It can be: 5,10,15,30,60 minutes.

6.5.3 PULSE RATE INPUT

As soon as the user accesses the “PULSE RATE INPUT” page, the system displays the data coming from the VMU-P EM modules, and more precisely from the inputs for digital input measurement (for frequency/speed measurement) of the module itself.

Accessing this page will display the daily trend of the variable monitored by the above-mentioned digital input.

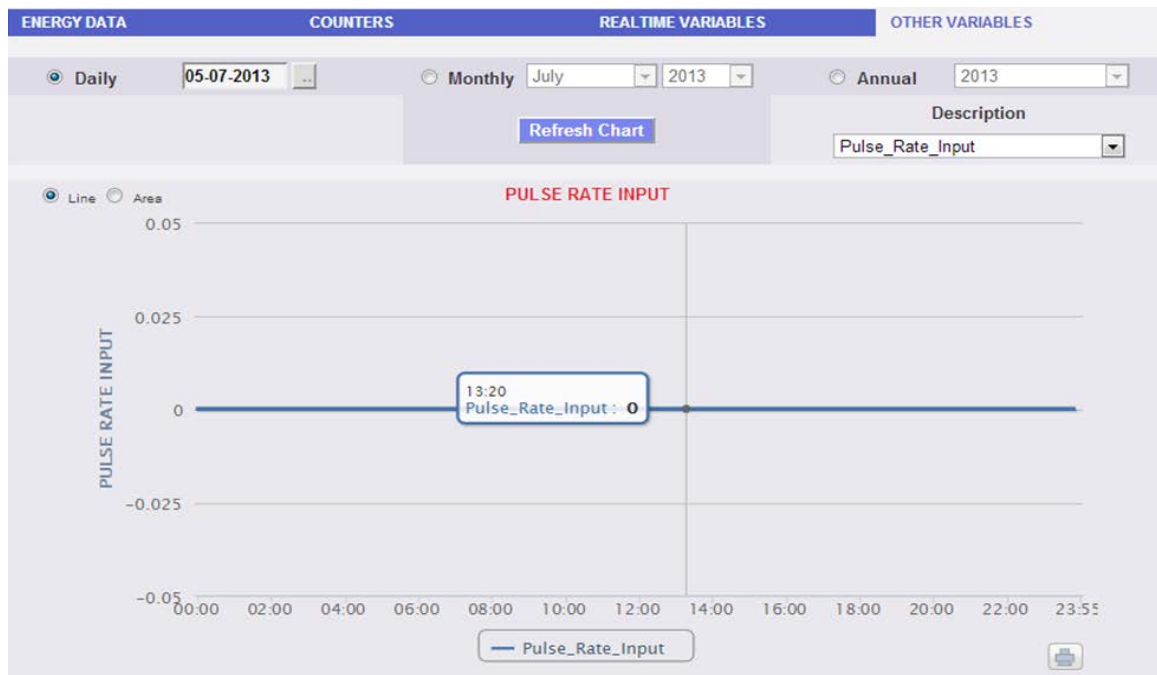

Digital input variable trend

This page consists of two sections:

“Section A” for search and selection (in the top section of the page)

It allows to select the display type, using the dark grey buttons:

- **Daily:** it displays the daily trend of the variable for the selected day. To choose the day use the special calendar which can be accessed through the button next to the date field.
- **Monthly:** it displays the daily average of the value monitored by the digital input, for every day of the selected month. To choose the month and year use the special selection menus next to the field.
- **Annual:** it displays the trend of the average (monthly) value monitored by the digital input, for each month of the selected year. To choose the year use the special selection menu next to the field.

VMU-C

After selecting the display type press the “Refresh Chart” button.

On the right there is the menu allowing to select the digital input. The list shall include all enabled inputs.

Note: all keys and selections outside the dark grey area do not need the “Refresh chart” function. After a few moments the chart will refresh automatically.

F. “**Section B**” displays in graphical form the trend of the selected variable.

On the ordinate axis (Y) the chart shows the scaled value for the monitored value (with auto-range function).

Two display types are available: “Line” track or “Area” track.

Note: in daily charts the sampling frequency depends on the storage interval set on VMU-C EM. It can be: 5,10,15,30,60 minutes.

7 GENERAL CHART FEATURES

7.1 ZOOM FEATURE

You can use the ZOOM function in any Chart display page, it allows you to zoom a particular area of the graph for further analysis.

The ZOOM function is fast and easy. The picture below shows the sequence of operations to perform:

Example of a graph that you want to further analyze. In particular, we want to analyze the area highlighted with the orange dotted area:

Move your mouse pointer “

Zoom Function

As soon as the left mouse button is released, the zoomed area is highlighted the performance of the charts can be further analysed:

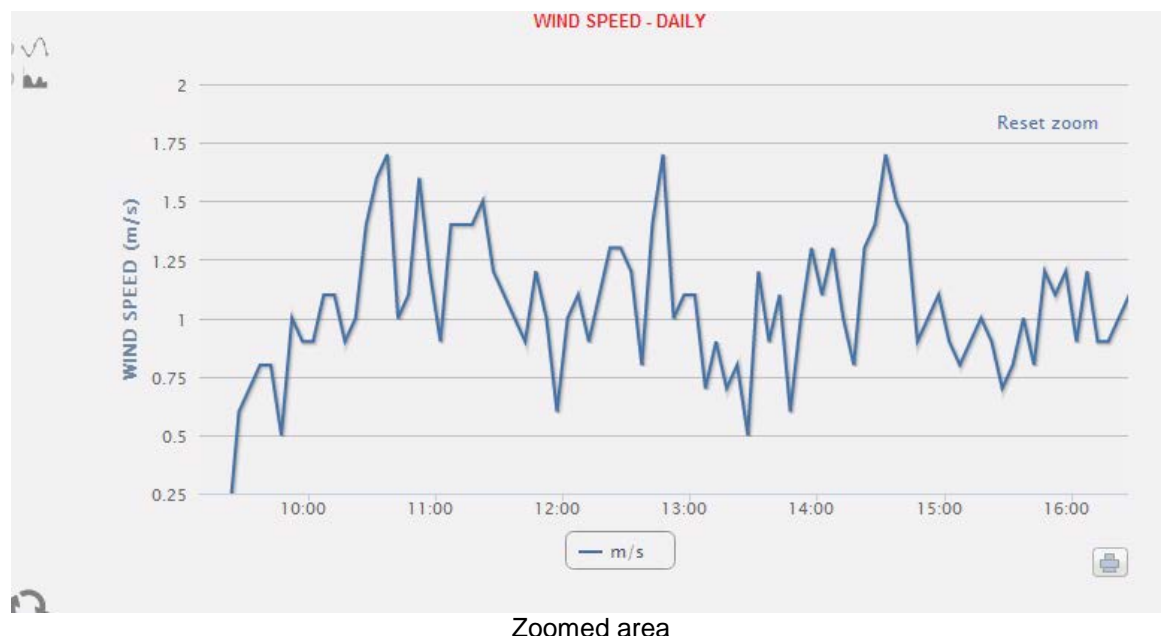

The zoom function is available for all chart types (histogram and area charts). By the RESET ZOOM button it is possible to come back to the initial scaling.

7.2 REFRESH FEATURE

By the refresh button, available in each chart in bottom-left position, it is possible to refresh the displayed view



7.3 PRINT FEATURE

By the PRINT button, available in each chart in bottom-right position, it is possible to print the present chart



7.4 CHART ACTION MENU

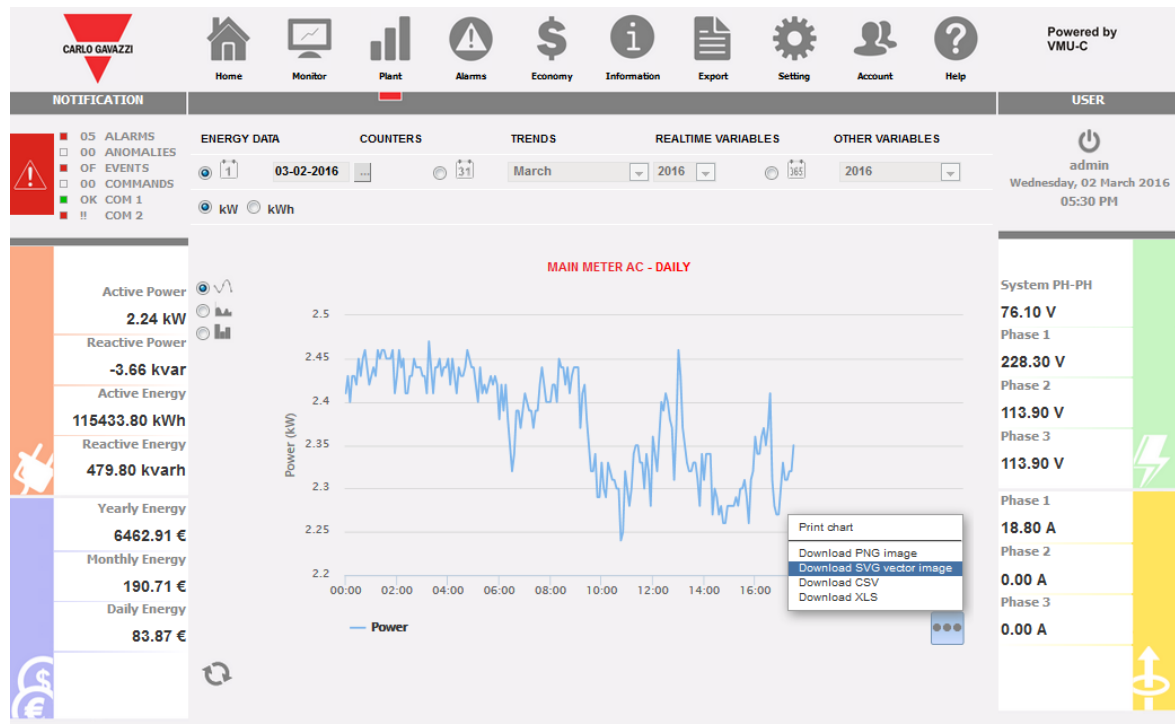

Chart action menu

By means of the 3-dots chart action menu (top right position) it is possible to export the present chart data with one click.

The available actions are:

- PRINT CHART
- DOWNLOAD PNG IMAGE
- DOWNLOAD SVG VECTOR IMAGE
- DOWNLOAD CSV file
- DOWNLOAD XLS file

8 ALARMS

This section is devoted to the management and display of the alarms which have occurred during installation. Clicking on the “Alarm” icon in the Navigation menu will grant access to the alerts content

ID	Message	Description	Module	Start Date	Start Time	End Date	End Time	Zone	Hide
5247	Power On	String-Box1	VMU-C	19-05-2014	01:52:01 PM			Amorphous	<input type="checkbox"/>
5246	Power Off	String-Box1	VMU-C	19-05-2014	01:51:26 PM			Amorphous	<input type="checkbox"/>
5243	Power On	String-Box3	VMU-M	19-05-2014	01:51:30 PM			Monocrystalline	<input type="checkbox"/>
5242	Power On	String-Box2	VMU-M	19-05-2014	01:51:30 PM			Polycrystalline	<input type="checkbox"/>
5241	Power Off	String-Box3	VMU-M	19-05-2014	01:51:25 PM			Monocrystalline	<input type="checkbox"/>
5240	Power Off	String-Box2	VMU-M	19-05-2014	01:51:25 PM			Polycrystalline	<input type="checkbox"/>
4144	Power On	String-Box1	VMU-C	22-04-2014	08:49:14 AM			Amorphous	<input type="checkbox"/>
4143	Power Off	String-Box1	VMU-C	22-04-2014	08:48:46 AM			Amorphous	<input type="checkbox"/>
4140	Power On	String-Box3	VMU-M	22-04-2014	08:48:53 AM			Monocrystalline	<input type="checkbox"/>
4139	Power On	String-Box2	VMU-M	22-04-2014	08:48:53 AM			Polycrystalline	<input type="checkbox"/>
4138	Power Off	String-Box3	VMU-M	22-04-2014	08:48:47 AM			Monocrystalline	<input type="checkbox"/>
4137	Power Off	String-Box2	VMU-M	22-04-2014	08:48:48 AM			Polycrystalline	<input type="checkbox"/>
4075	Power On	String-Box1	VMU-C	11-04-2014	08:31:02 AM			Amorphous	<input type="checkbox"/>
4074	Power Off	String-Box1	VMU-C	11-04-2014	08:30:35 AM			Amorphous	<input type="checkbox"/>
4071	Power On	String-Box3	VMU-M	11-04-2014	08:30:43 AM			Monocrystalline	<input type="checkbox"/>
4070	Power On	String-Box2	VMU-M	11-04-2014	08:30:43 AM			Polycrystalline	<input type="checkbox"/>

Alarms

This table shows the list of alarms stored in VMU-C EM in chronological order, starting from the most recent.

Note: alarm classification cannot be changed by user.

Alarms are divided into three categories, each one with a different colour assigned to it.

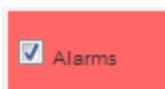

“**Alarms**” include all the warnings associated with the temperature measurements and with the measurements from analogue and digital inputs (from the VMU-M EM and/or VMU-P EM). Any alarm due to the overstepping of the thresholds set in the VMU-C EM for the energy meter instruments causes a warning inside the “ALARM” category. This type of event generally inform the user of a situation which needs to be resolved quickly in the monitored system.

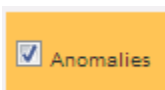

“**Anomalies**” include all the statuses from the monitored devices and signalling an incorrect operation of the temperature probes (short-circuited or disconnected probe), or any notifications of communication problems on the internal bus or on one of the two

RS485 buses (should a device installed and enabled for communication on bus RS485 fail to communicate for over 30 seconds, an “Anomaly” message will be generated). Anomalies generally inform the user of a situation which needs to be resolved quickly in the monitored system.

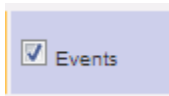

“Events” include all the status changes of digital inputs, the power supply status change (on/ff) and all the changes in the configuration of the instruments or modules connected and monitored by the VMU-C EM.

- Filter application on alarm table view

The following controls are available:

<p>Alerts filter To filter the desired subset of alerts</p>	<input checked="" type="checkbox"/> Alarms <input checked="" type="checkbox"/> Anomalies <input checked="" type="checkbox"/> Events <input checked="" type="checkbox"/> Commands
<p>Buttons bar Allowing to : -HIDE ALL: to apply the HIDE check to all the alarms -DELETE: to delete all the alarms -COMMANDS: to open the COMMANDS page (see the further section)</p>	<div style="border: 1px solid gray; padding: 5px; display: flex; justify-content: space-around;"> Hide All Delete Commands </div>
<p>View only open alarms check To include only open alarms in the list</p>	<input checked="" type="checkbox"/> View only open Alarms
<p>Show All check To view all the alarms including the hidden ones</p>	<input type="checkbox"/> Show All

- "Alarms" table fields

The Alarms table shows the following fields:

1. “ID”: Event identification number (Alarm or Anomaly or Event). This meter is only reset when all existing messages have been deleted.
2. “Message”: alarm description.
3. “Description”: name assigned to the device during configuration.
4. “Module”: address of the primary device (VMU-C EM or relevant VMU-M EM or Energy Meter) and position of the secondary device (VMU-P or VMU-O) in alarm.
5. “Start date”: date on which the alarm occurred.
6. “Start time”: time at which the alarm occurred.

7. **“End date”**: date on which the alarm ceased. If alarm still exists, the field will be blank.
8. **“End time”**: time at which the alarm ceased. If alarm still exists, the field will be blank.
9. **“Hide”**: if checked, the alarm row will be automatically hidden.

Note: To view all alarms, including the hidden ones, check “Show all” in the top right section of the screen. If the option is selected, a hidden alarm can be viewed again by simply unchecking “Hide”.

8.1 COMMANDS

PLANT SETUP - COMMANDS					
<input type="text" value="All Outputs Test"/>		<input type="button" value="ON"/>		<input type="button" value="OFF"/>	
<input type="text"/>	<input type="button" value="ON"/>	<input type="button" value="OFF"/>	<input type="text"/>	<input type="button" value="ON"/>	<input type="button" value="OFF"/>
<input type="text"/>	<input type="button" value="ON"/>	<input type="button" value="OFF"/>	<input type="text"/>	<input type="button" value="ON"/>	<input type="button" value="OFF"/>
<input type="text"/>	<input type="button" value="ON"/>	<input type="button" value="OFF"/>	<input type="text"/>	<input type="button" value="ON"/>	<input type="button" value="OFF"/>
<input type="text"/>	<input type="button" value="ON"/>	<input type="button" value="OFF"/>	<input type="text"/>	<input type="button" value="ON"/>	<input type="button" value="OFF"/>
<input type="text"/>	<input type="button" value="ON"/>	<input type="button" value="OFF"/>	<input type="text"/>	<input type="button" value="ON"/>	<input type="button" value="OFF"/>
<input type="text"/>	<input type="button" value="ON"/>	<input type="button" value="OFF"/>	<input type="text"/>	<input type="button" value="ON"/>	<input type="button" value="OFF"/>
<input type="text"/>	<input type="button" value="ON"/>	<input type="button" value="OFF"/>	<input type="text"/>	<input type="button" value="ON"/>	<input type="button" value="OFF"/>
<input type="text"/>	<input type="button" value="ON"/>	<input type="button" value="OFF"/>	<input type="text"/>	<input type="button" value="ON"/>	<input type="button" value="OFF"/>
<input type="text"/>	<input type="button" value="ON"/>	<input type="button" value="OFF"/>	<input type="text"/>	<input type="button" value="ON"/>	<input type="button" value="OFF"/>
<input type="text"/>	<input type="button" value="ON"/>	<input type="button" value="OFF"/>	<input type="text"/>	<input type="button" value="ON"/>	<input type="button" value="OFF"/>

Commands setup

The COMMANDS setup page is opened by the relevant PUSH button in the Alarms section.

By this page it is possible to change explicitly the ON or OFF status of the relevant output configured in the VMU-O module (see the relevant instructions in the Configuration Wizard section)

9 ECONOMIC ANALYSIS

This section is devoted to the economic analysis of the installation. It allows to calculate the costs of the consumed AC energy.

Clicking on the “Economy” icon in the Navigation menu will grant access to the relevant content -

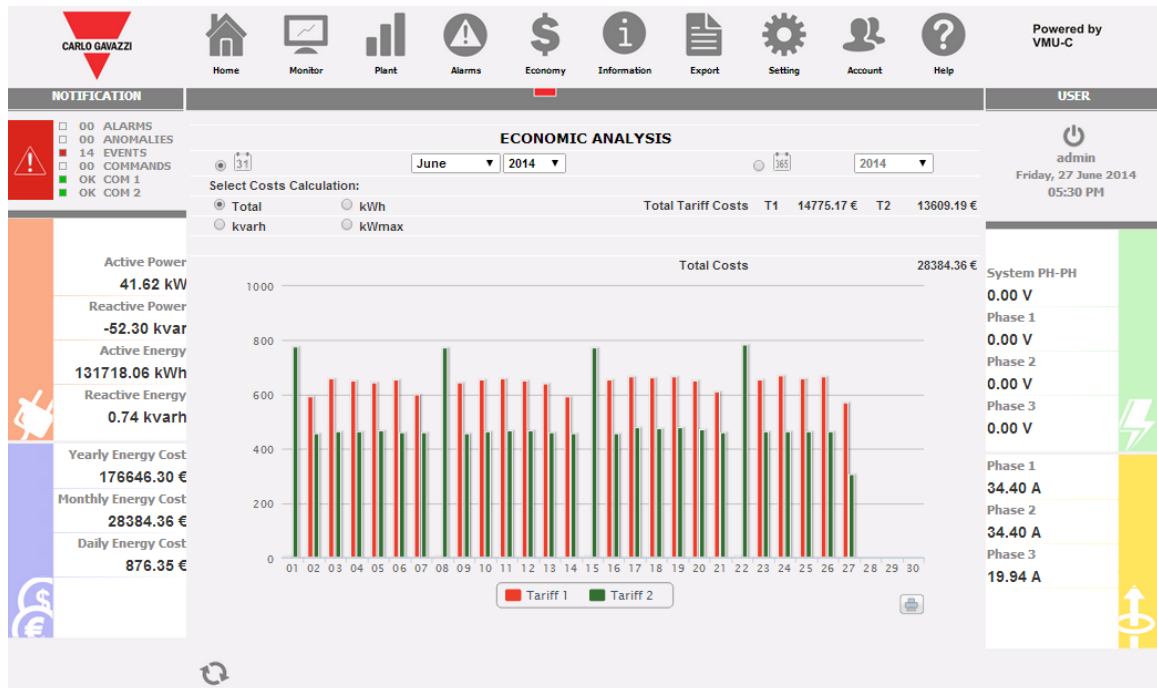

Economic analysis

As soon as the user accesses the page, the chart displays, for the current month (with a daily resolution), the total cost in € of the amount of energy consumed, taking into account the two tariffs (T1 and T2) previously set by the user. To select another month or a yearly time interval, use the dark grey section on top and press the “Refresh chart” button.

The chart displayed above provides 4 different selections (Section “A”), referring to the total energy consumption in the selected month, or just to the active or reactive energy. A further selection is also available to display, for each tariff, the date on which the highest consumption has occurred.

- **Total:** each histogram represents the total consumption (for each tariff) of the day. The value takes into account both the consumed active energy value (kWh) and the reactive component (kvarh). The fixed monthly cost is also considered in calculating the daily values.
- **kWh:** each histogram represents the total consumption (for each tariff) of the day. The value only takes into account the consumed active energy value (kWh).
- **kvarh:** each histogram represents the contribution (for each tariff) due to the reactive energy (kvarh) injected into the network for the day.
- **kWmax:** this chart allows to identify the day of the month in question on which the maximum power absorption (kWmax for each time band) has occurred. This value is only displayed in case it should exceed the contract power threshold previously set by the user. The value is expressed in the currency set in the setup page.

Note: for the four chart types described above, the value expressed on the Y axis must always refer to the cost expressed in the currency set during programming.

In the “**B**” section area, with reference to the selections made in section “**A**”, the system will display the total values for each time band (T1 and T2) and the relevant total.

10 INFORMATION

This section displays the data and characteristics of the monitored plant. Clicking on the “Information” icon in the Navigation menu will grant access to the relevant content

The screenshot shows the VMU-C Information page. At the top is a navigation menu with icons for Home, Monitor, Plant, Alarms, Economy, Information (selected), Export, Setting, Account, and Help. Below the navigation is a notification bar with a red warning icon and a list of notifications: 01 ALARMS, 00 ANOMALIES, 69 EVENTS, 00 COMMANDS, COM 1, and OK COM 2. The main content area is divided into three sections: VMU-C STATUS (selected), PLANT CHARACTERISTICS, and DATABASE STATUS. The VMU-C STATUS section displays the following information:

- VMU-C SERIAL NUMBER : BN0300006001U
- MAC ADDRESS : 00:19:EE:10:01:50
- FIRMWARE VERSION : A9_M12_B04
- CONNECTED VMU-M : 0
- CONNECTED AC METERS : 1
- ETHERNET STATUS :
- MODEM STATUS :
- SERVER SYNC STATUS :

On the left side, there is a sidebar with energy data:

- Active Power: 3.48 kW
- Reactive Power: -5.58 kvar
- Active Energy: 54859.80 kWh
- Reactive Energy: 53.00 kvarh
- Yearly Energy: 0.00 €
- Monthly Energy: 0.00 €
- Daily Energy: 0.00 €

At the bottom of the page, there is a status bar: VMUC-EM - ND - ENERGY METERS (DATABASE: 0.29%) and the text "Plant characteristics".

There are 3 sub-selections available from the information page:

1. VMU-C Status
2. Plant characteristics
3. Database status

10.1 VMU-C STATUS

By this page it is possible to check in real time the main configuration settings relevant to the VMU-C device.

VMU-C STATUS
 PLANT CHARACTERISTICS

VMU-C STATUS

VMU-C SERIAL NUMBER : BO0280002001U

MAC ADDRESS : 00-19-EE-10-01-55

FIRMWARE VERSION : A5_B23

CONNECTED VMU-M : 1

CONNECTED AC METERS : 4

ETHERNET STATUS : ■

MODEM STATUS :

SERVER SYNC STATUS : ■

VMU-C Status

Parameter	Description
VMU-C Serial Number	It is the unique S/N of the VMU-C
MAC Address	It is the unique MAC address of the VMU-C's Ethernet port
Firmware version	The present firmware version in use in the VMU-C
Connected VMU-M	The connected VMU-M's count (on COM1)
Connected AC Meters	The connected Energy Meters' count (on COM1)
Ethernet Status	The Ethernet status (RED in the case of issues)
Modem Status	The VMU-W modem status (RED in the case of issues)
Server Sync Status	The status of data synchronization with the remote Eos-Server or VMU-Y in the case one of those systems is in use (RED in the case of issues)

10.2 Plant characteristics

VMU-C STATUS PLANT CHARACTERISTICS

PLANT CHARACTERISTICS

Plant Name

Plant Location

Plant Property

Installer

VMU-C Installation Date

CONTRACT HIGHLIGHTS

	Fixed Monthly Costs	kWh Unit Cost	kvarh Unit Cost	Wmax Monthly Cost	Max Contractual Peak
Tariff 1	200.0 €	1.5 €	0.5 €	3.0 €	100.0 kW
Tariff 2	150.0 €	0.75 €	0.5 €	3.0 €	100.0 kW

TARIFF CALENDAR CONFIGURATION

Tariff T1 Interval	Working Day	T1 Start 1	T1 End 1		T1 Start 2	T1 End 2
		<input type="text" value="08"/>	<input type="text" value="12"/>	--	<input type="text" value="13"/>	<input type="text" value="18"/>
Holidays	<input type="checkbox"/> Mon <input type="checkbox"/> Tue <input type="checkbox"/> Wen <input type="checkbox"/> Thu <input type="checkbox"/> Fri <input checked="" type="checkbox"/> Sat <input checked="" type="checkbox"/> Sun					

All period outside tariff T1 range, are automatically included in the tariff T2. All holidays are included into tariff T2.

Plant characteristics

This page consists of three sections:

1. “*Description*”: it displays the plant identification data (name, place and date of installation, etc. ...).
2. “*Contract highlights*”: for each tariff the section specifies the fixed costs, the unit cost for both active (kWh) and reactive (kvarh) energy, the maximum contract power value for each individual tariff, and finally any additional cost (for each kW), should the maximum contract power be exceeded.
3. “*Tariff calendar configuration*”: it displays the start/end time for each tariff. It also specifies the week days which shall be considered as holidays.

Note: any time periods not included in tariff “T1” are automatically included in tariff “T2”. Days defined as “holidays” shall be entirely counted in tariff “T2”.

10.3 Database characteristics

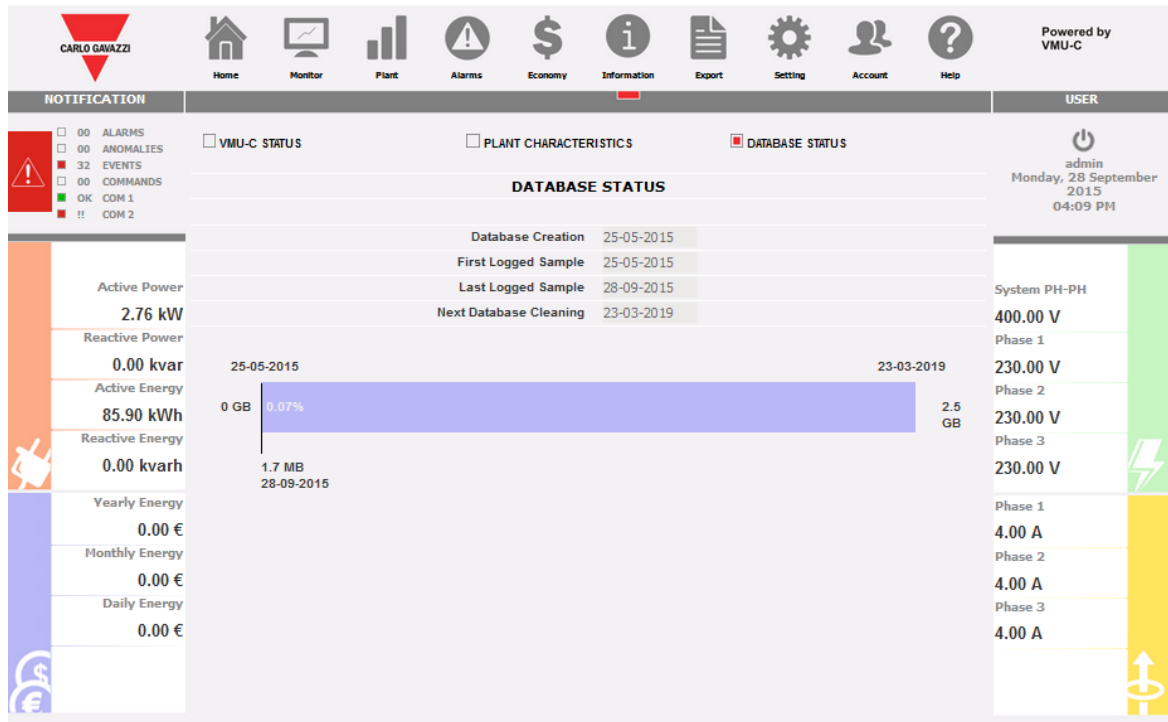

By this view, it is possible to check the present database occupation; VMU-C's Database is organized with a FIFO logic: information with the highest granularity are periodically averaged (from high granularity to daily granularity) and then deleted daily, so as not to exceed the available storage space. This means then the database grows until the maximum size is raised and then the VMU-C self adapts itself to not to exceed that threshold. The two dates at the endpoints of the bar represent the FIFO interval, for which samples at highest granularity are available. A slider shifts through the bar, so as to display the present database occupation.

11 DATA EXPORT

This section allows to export the data stored in VMU-C EM to an Excel file. Clicking on the “Export” icon in the Navigation menu grants access the following screen

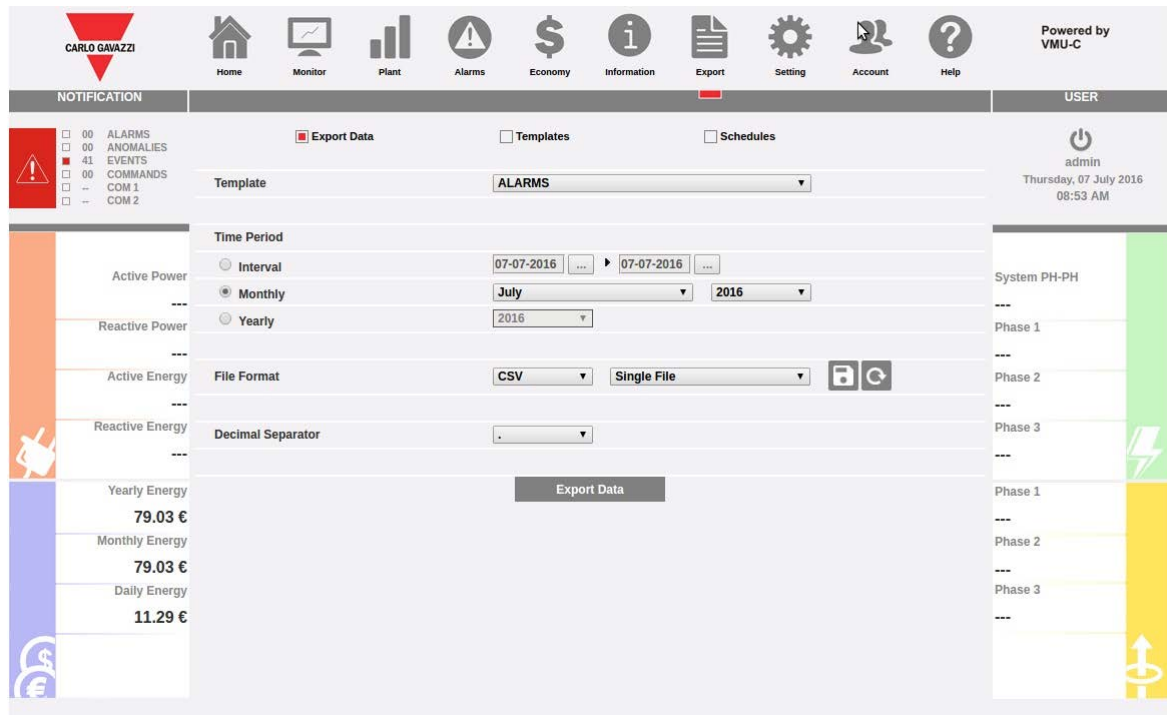

Exporting stored data

This area allows to choose the type of data to be exported and the relevant period. It includes 3 sections:

1. Export Data:
2. Templates
3. Schedules

11.1 Exporting data

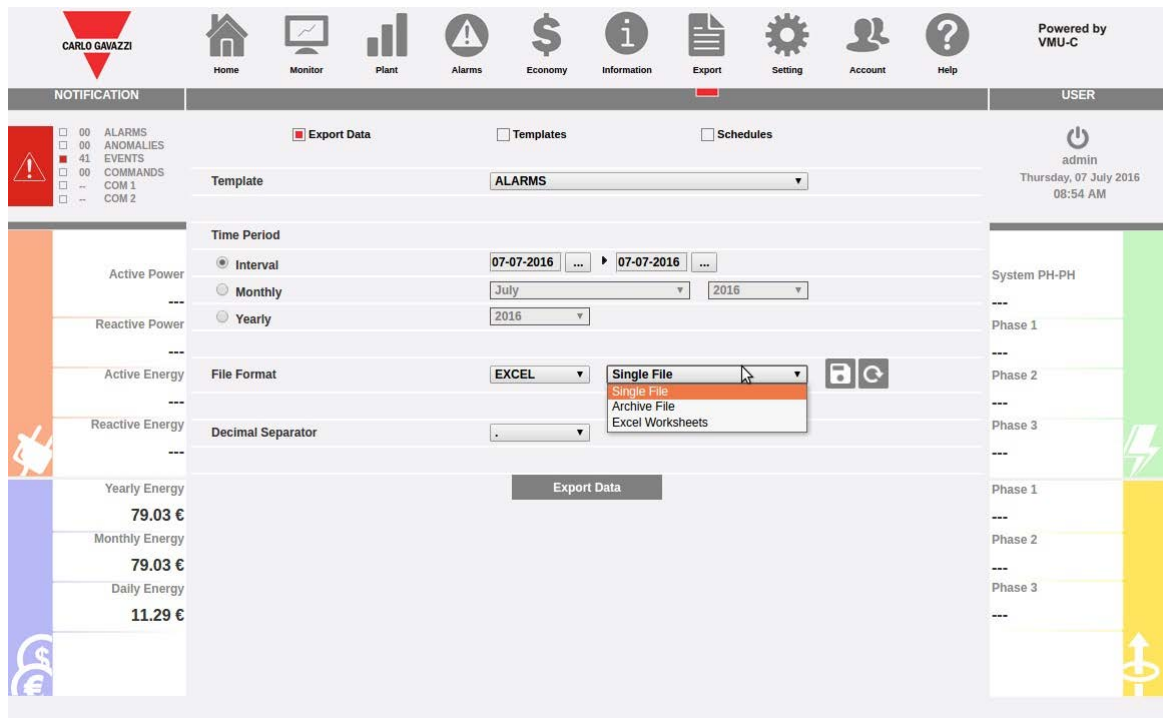

File format selection

From this section you can choose the parameters for immediate export:

Parameter	Description
Template	It is the mix of variables and meters whose data you wish to export. You can choose among the available templates (see template section)
Time interval	It is the time interval for data searching; you can choose among: <ul style="list-style-type: none"> • Free interval (from day to day) • Month • Year
File format	It allows to choose the exported data file format: <ul style="list-style-type: none"> • CSV • XLS • HTML (compatible with Excel) If the file format is EXCEL, it allows to export the data as: <ul style="list-style-type: none"> • Single file • Store (containing multiple files) • Excel file with multiple sheets
Decimal separator	It allows to chose the decimal separator for text-type export formats (CSV, HTML)

Once you launch the export function the data files will be generated in the format you selected and exported to the client computer.

11.2 Templates

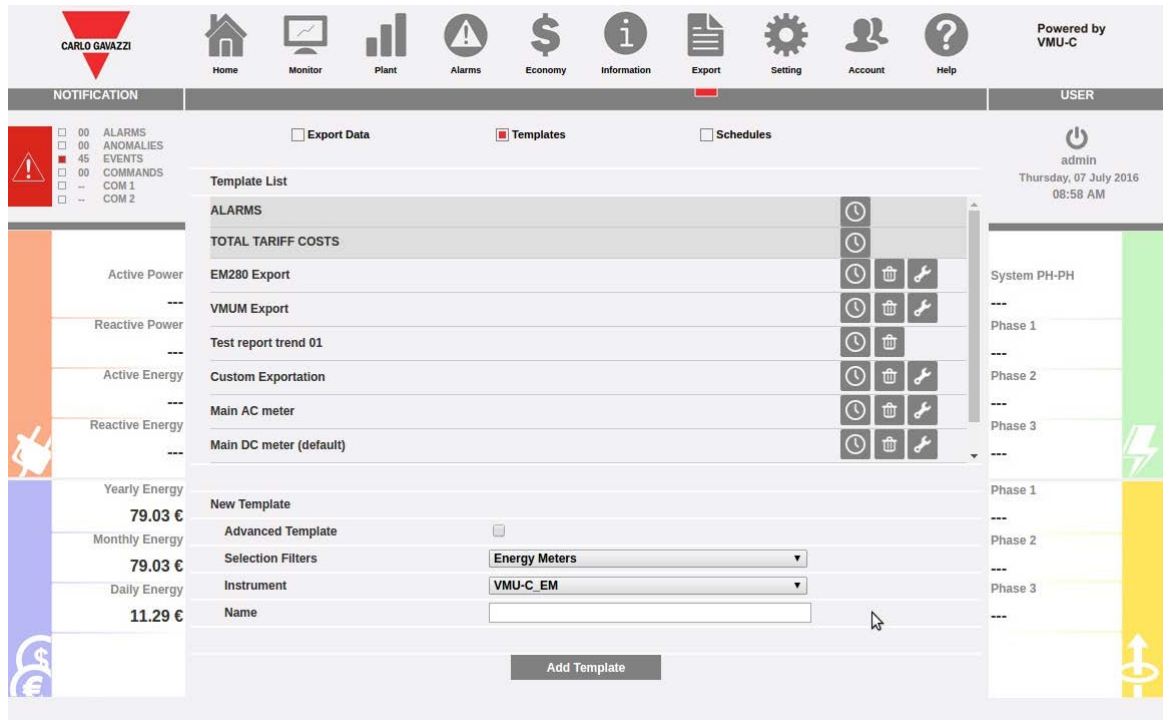

TEMPLATES management page

In the TEMPLATES page you can create, edit or remove Templates. You can choose between 2 template creation modes: simplified and advanced. The simplified mode allows to quickly create a template by choosing a meter and a group of variables. The advanced mode allows to flexibly create a template as a mix of variables from one or more meters.

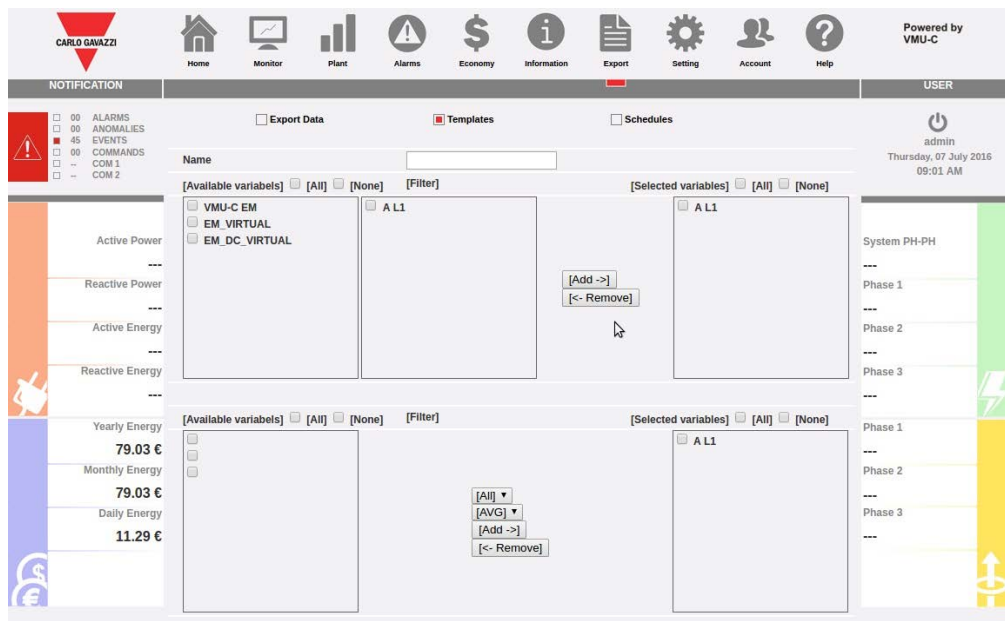

Creating TEMPLATES in advanced mode

In the frames you can choose meters, sub-meters (if any), variables and variable types (average, max, min), as needed.

11.1 Schedules

SCHEDULES screen

The screen shows the list of the schedules you created, allowing you to edit them, to delete them or to create new ones.

When you choose to edit or create a schedule, the system will display the SCHEDULES editing page:

SCHEDULES editing page

VMU-C

In the schedule creation page you can choose a Template among the available ones (see the TEMPLATES section), assign a name to the report and define a mailing list of e-mail addresses that will receive the file, as well as define the file format and the scheduling period.

You can also verify that the report has been sent properly through the TEST MAIL function.

Once scheduling has been enabled, the report will be sent at midnight, at the specified date (end of the day, end of the week, end of the month, end of the year).

12 ACCOUNT

Clicking on the “Account” icon in the Navigation menu will grant access to the Account configuration section devoted to users management for access to system.

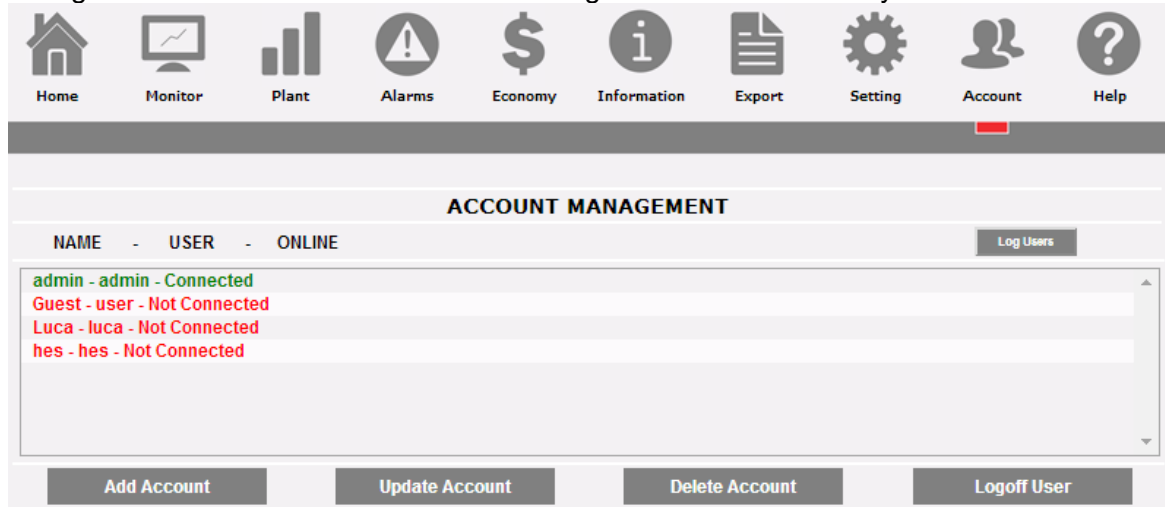

Account Menu

12.1 ACCOUNT MANAGEMENT

Accesses to the system are managed by creating two user types with different privileges.

- A. The “**Administrator**” type account has access to all software areas: “*System configuration*”, “*Account configuration*”, “*Data display*”.
- B. The “**User**” type account is only allowed to access the “*Data display*” area.

The system has a default Administrator type user, with these characteristics:

Username	Password	Name
admin	admin	Administrator

It is recommended to modify the default user during the first configuration.

Note: An *Administrator* type user must always exist in the system; in its absence, access to System configuration and Account configuration areas will no longer be allowed. To restore the Administrator user, contact Carlo Gavazzi technical assistance.

To know which users are online just refer to the list displayed in the dotted area in Fig. 115. Logged-in users are shown in green and are marked with “Logged-in”; other users are shown in red and are marked with “Not logged-in”.

12.2 ADDING A NEW ACCOUNT

Press the “Add account” button. The following screen will be displayed in the bottom section of the page:

ADD ACCOUNT	
NAME	<input type="text"/>
Username	<input type="text"/>
Password	<input type="password"/>
LEVEL	User ▼
<div style="display: flex; justify-content: space-around;"> Add Reset Cancel </div>	

add account

Fill in the fields according to the following specifications:

- “Name”: Name of the user.

Note: We recommended that you never assign the same “Name” to two different users.

- “USERNAME”: Username for access to the system.

Note: Two users with the same “Username” cannot be entered.

- “PASSWORD”: Password for access to the system.
- “LEVEL”: user level: User/Administrator.

Press “Reset” key to delete the contents of various fields; “Cancel” to cancel operation. Press “Add” key to enter account and add it to the list.

12.3 UPDATING AN ACCOUNT

Select the account to be modified from the "Inserted accounts" list (Fig. 115). Press the “Update account” button. The following screen will be displayed in the bottom section of the page:

UPDATE ACCOUNT	
NAME	Guest
Username	user
Password	****
LEVEL	User ▼
<div style="display: flex; justify-content: space-around;"> Save Reset Cancel </div>	

Modify the settings as already described in paragraph "New account insertion" above, taking into account that the Username field cannot be edited. Press the "Reset" button to cancel the modifications; "Cancel" to cancel the operation. Press the "Save" button to modify the account.

12.4 DELETING AN ACCOUNT

Select the account to be deleted from the list shown in Fig. 150. Press the "*Delete account*" button. The confirmation message appears on the centre of the page. Press "OK" key to confirm deletion or "Cancel operation" to cancel.

12.5 LOGGING OFF AN ACCOUNT

The administrator user can disconnect a user included in the list by a forced log-off operation. To disconnect a user, displayed in green and with the "Logged-in" indication next to it, press the "*Log-off user*" button. All the users connected with that Username will be disconnected and re-routed to the home page.

12.6 HISTORY OF ACCESSES TO THE SYSTEM

Clicking on "Users Log" will open a window containing the history of the accesses to VMU-C-Box, including date and time. Rows in green show the users which are currently online.

User	Logged	IP	Last Login
admin	Connected	192.168.3.104	21-05-2014
admin	Connected	88.32.230.180	21-05-2014
admin	Not Connected	88.32.230.180	21-05-2014
admin	Not Connected	88.32.230.180	21-05-2014
admin	Not Connected	88.32.230.180	20-05-2014
admin	Not Connected	88.32.230.180	20-05-2014
admin	Not Connected	88.32.230.180	20-05-2014
admin	Not Connected	88.32.230.180	20-05-2014
admin	Not Connected	88.32.230.180	20-05-2014
admin	Not Connected	88.32.230.180	20-05-2014
admin	Not Connected	88.32.230.180	19-05-2014
admin	Not Connected	88.32.230.180	19-05-2014
admin	Not Connected	192.168.3.76	19-05-2014
admin	Not Connected	192.168.3.75	19-05-2014

Access LOG

VMU-C

The chronology keeps access data for a week; date and time refer to login phase. Click on the captured IP address to find the user's origin area.

13 DATA BACK-UP

- *Data back-up on external memory (optional)*

Using a “Micro SD” or “SDHC” memory card appropriately inserted in the relevant slot or a PenDrive directly connected to the USB port , you can back up the data existing in the VMU-C EM database.

Note: the Micro SD card is not supplied with VMU-C. VMU-C supports Micro SD or PenDrive cards whose capacity doesn't exceed 16GB.

- *Micro SD installation*

1. Open the flap located on the front section of VMU-C EM. Identify the slot specifically designed for the insertion of the “Micro SD” memory

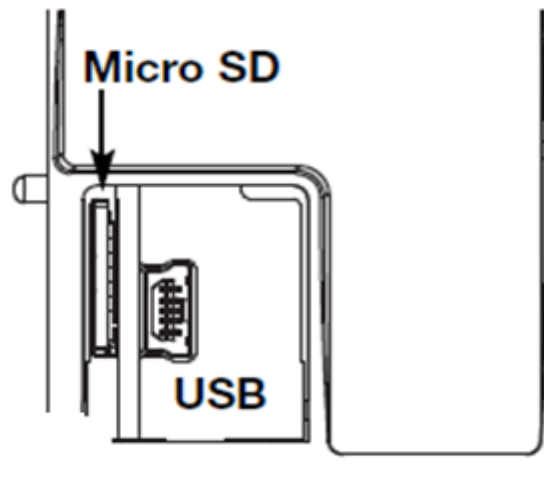

Slot for Micro SD cards

2. Insert the Micro SD card, making sure it is not write-protected and it is properly formatted (FAT32).
3. Close the flap back. Warning: if the flap is not properly closed VMU-C EM will not enable any writing or reading operation (flap closing is controlled by a micro switch located under the flap).
4. As soon as the flap is closed, VMU-C EM will install the newly inserted memory card and transfer the BACK-UP data. As long as the installation and writing operations are under way, the front “ON” LED (green) will blink. Warning: opening the flap during the writing stage will stop the data transfer process and might damage the Micro SD memory.

- *Pen-drive installation*

1. Identify the USB port specifically designed for the insertion of the “Pen Drive” memory 7

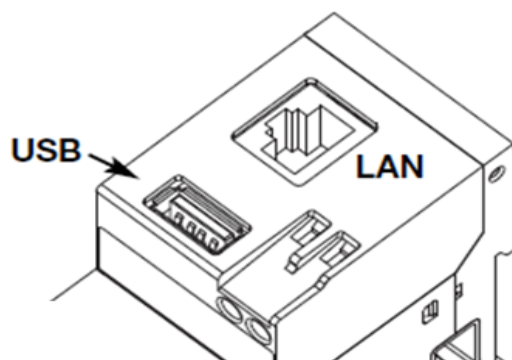

Slot for Micro SD cards

2. Insert the Pen-drive, making sure it is not write-protected and it is properly formatted (FAT32).
3. As soon as you have inserted the Pen-drive, VMU-C EM will install the memory and transfer the BACK-UP data. As long as the installation and writing operations are under way, the front “USB” LED (blue) will blink. Warning: disconnecting the Pen-drive during the writing stage will stop the data transfer process and might damage the memory.

The Back-up operation starts as soon as the memory device (micro SD or Pen Drive) is inserted. At the end of the operation, the memory device will contain a folder named VMUC_”VMU-C name” fig. 122), whose content is described below:

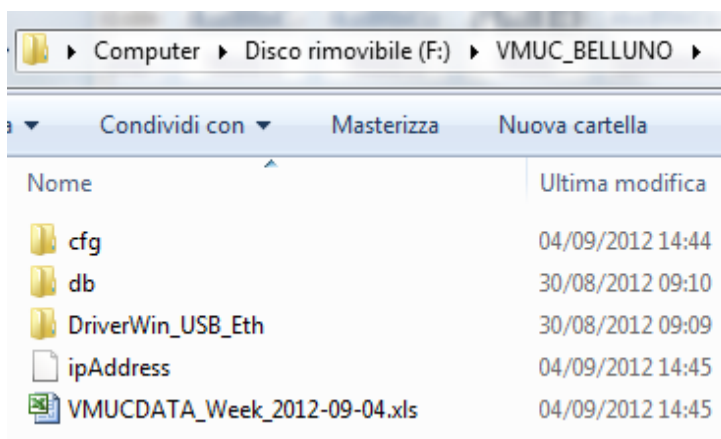

VMU-C' s backup folder content

Note: The name of the folder VMU-C EM automatically creates at switch-on (or when the memory device is inserted) consists of a fixed part “VMU-C, automatically followed by the name assigned to the VMU-C itself. For example, the folder name might be something like VMUC_BELLUNO. This operation, which VMU-C EM

performs automatically, will prevent the databases of different VMU-C from being overwritten.

- Folder “**cfg**”
- Folder “**db**”
- Folder “**DriverWin_USB_Eth**”
- File “**ipAddress**”
- EXCEL file “**VMUCDATA week_.....**”

The “**cfg**” folder contains two files:

- 1) EWgeneral.db: it contains the general system configuration, the IP address, the scheduled operations, the e-mail addresses for the sending of scheduled messages or in case of alarm, etc.
- 2) EWplant.db: it contains the plant configuration (the system configuration, installed modules, RS485 network addresses, threshold settings, etc.).

The “**db**” folder contains the whole VMU-C EM database. This folder contains all the data stored in VMU-C EM and updated as of 24:00 of the previous day. Should the VMU-C EM get damaged and have to be replaced, this folder allows to move the whole Database and the relevant configuration from the damaged instrument to the new one through a “**Disaster-Recovery**”-type function.

“**DriverWin_USB_Eth**” folder it contains a Windows driver allowing to connect the VMU-C EM to the PC through the mini USB communication port. In this case the reference address (fixed and not editable) is 192.168.254.254. To access the VMU-C EM through the mini USB port use a USB => mini USB cable and type through the browser in use the address 192.168.254.254; the log-in page will be displayed again.

“**ipAddress**” file: it contains the IP addresses of the connected devices.

Note: we recommend that you use “Notepad” to display this file.

EXCEL file “**VMUCDATA week_.....**”: a file containing all the data logged by VMUC_EM in the last 7 days. The file (Fig. 123) will contain the following variables:

- Total active energy read by the reference energy meter (kWh)
- Average active power over the period read by the reference energy meter (kW)
- Total reactive energy read by the reference energy meter (kvarh)
- Average reactive power over the period read by the reference energy meter (kvar)

Note: For all the variables mentioned above, the period corresponds to the logging interval set on VMU-C. This interval can be of: 5,10,15,30,60 minutes.

	A	B	C	D	E
1	Date 2013-07-07	Energy on period (read from energy meters) (kWh)	Instantaneous Power (read from energy meters) (kW)	Energy on period (read from energy meters) (kvarh)	Instantaneous Power (read from energy meters) (kvar)
2	00:00	0	0	0	0
3	00:05	0	0	0	0
4	00:10	0	0	0	0
5	00:15	0	0	0	0
6	00:20	0	0	0	0
7	00:25	0	0	0	0
8	00:30	0	0	0	0
9	00:35	0	0	0	0

Excel backup file

VMU-C

If the memory device (micro SD or Pen Drive) is left inserted into VMU-C EM, at 12:00 a.m. o'clock VMU-C adds on a daily basis a new file containing the data of the just expired day (with the same formatting as the previous file).

Nome	Ultima modifica	Tipo	Dimensione
cfg	23/04/2012 12:43	Cartella di file	
DriverWin_USB_Eth	20/04/2012 15:24	Cartella di file	
ipAddress	23/04/2012 16:13	File	2 KB
VMUCDATA_Day_2012-04-23.xls	23/04/2012 22:10	Foglio di lavoro di...	49 KB
VMUCDATA_Week_2012-04-23.xls	23/04/2012 16:14	Foglio di lavoro di...	339 KB

New daily backup file

13.1 RESTORING THE CONFIGURATION FROM BACK-UP (FROM FILE)

If the VMU-C configuration has previously been saved on a PC, it can be re-imported by simply following the procedure described below:

- Click on the “*SETUP*” icon => Click on the “*PLANT*” button => Click on the “*SETTING*” button => Click on the “*WIZARD*” button => Click on the “*IMPORT*” button

The system will display the “Load configuration from file ...” mask 7

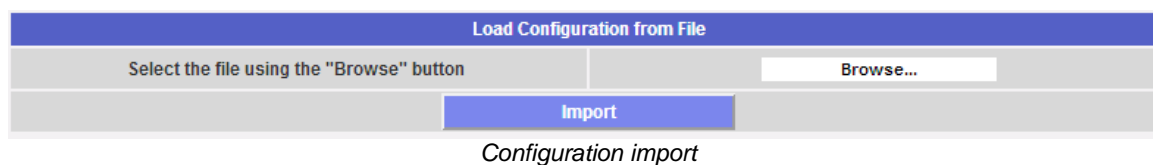

To select the file you wish to import, use the “**Browse**” button to retrieve the configuration file previously saved on the PC.

As soon as the file has been selected, the “**Import**” item will be enabled.

13.2 RESTORING THE DATA-BASE FROM BACK-UP (DISASTER RECOVERY)

If a memory pen or a micro SD memory card was inserted in VMU-C the following screen will be displayed:

SYSTEM	PLANT	SENSORS
Load Configuration from File		
Select the file using the "Browse" button		Browse...
Import		
Import Configuration from USB		
VMUC_VMU-C		
<input checked="" type="radio"/> Import Plant Configuration	<input type="radio"/> Disaster Recovery	
Import		
Import Configuration from microSD		
VMUC_VMU-C		
<input checked="" type="radio"/> Import Plant Configuration	<input type="radio"/> Disaster Recovery	
Import		

Database Restore

The screen in question allows to access two distinct operations:

- Import Plant Configuration
- Disaster Recovery

13.2.1 CONFIGURATION RESTORE

Performing this operation is equivalent to “Restoring the configuration from back-up”. When an external memory device (Pen-drive or micro-SD) is inserted into VMU-C EM, a copy of the system configuration (Arrays modules and Energy Meters) is automatically created; the copy in question can then be imported through a special command.

Import Configuration from USB		
VMUC_VMU-C		
<input checked="" type="radio"/> Import Plant Configuration	<input type="radio"/> Disaster Recovery	
Import		
Import Configuration from microSD		
VMUC_VMU-C		
<input checked="" type="radio"/> Import Plant Configuration	<input type="radio"/> Disaster Recovery	
Import		

Configuration Restore

13.2.2 DATABASE RESTORE (Disaster Recovery)

This operation allows to import into a VMU-C EM the Database of another VMU-C EM (this function can be very useful in case the device should have to be replaced as a consequence of a failure). The “Disaster Recovery” function imports into the new device all the data previously saved in the VMU-C EM which has failed (data-logger + events). This function is only available if the back-up memory (Pen-drive or micro-SD) remains constantly inserted into the VMU-C EM.

The image shows two identical UI panels for importing configuration. The top panel is titled 'Import Configuration from USB' and the bottom panel is titled 'Import Configuration from microSD'. Both panels feature a dropdown menu with 'VMUC_VMU-C' selected. Below the dropdown are two radio buttons: 'Import Plant Configuration' (unselected) and 'Disaster Recovery' (selected). A blue 'Import' button is located at the bottom of each panel. A red dashed rectangular box highlights the 'Disaster Recovery' radio button in both panels.

Database Restore

14 MODBUS Driver Editor

14.1 Abstract

The MDE (Modbus Driver Editor) is a flexible platform aimed at developing MODBUS drivers for VMU-C so as to connect MODBUS meters either by RS485 or Ethernet and gather data from them according to their MODBUS protocol.

14.2 MDE launching

MDE (MODBUS Driver Editor) is available only to users with ADMINISTRATOR profile. The tool is launched by the relevant menu item in the SETTINGS group (see the image below).

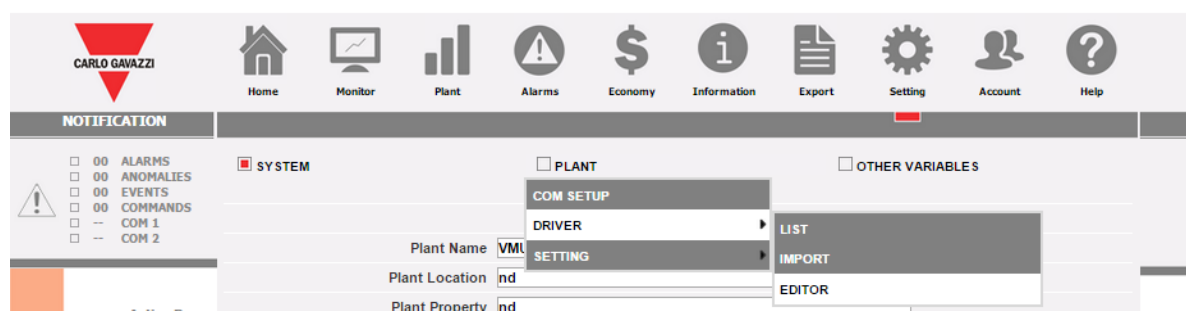

14.3 MDE overview

There are 2 views available from the MDE:

- List view: showing the list of the available drivers, highlighting their status
- Tree view: showing the inner hierarchy of a driver for a specific device

14.3.1 MDE List view

The list view includes 3 areas:

- Main area: at the center of the window, it displays the list's information
- Toolbar: at the top, it includes the usual menu icons of the VMU-C
- MDE function bar: contextual bar, showing the available functions in the current context

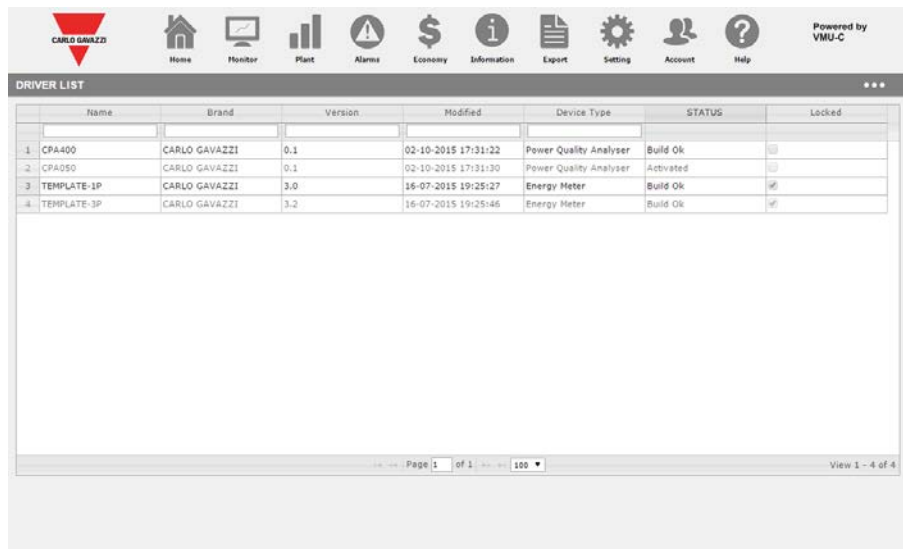

14.3.2 Functions available in the MDE's LIST view

Function	Description
NEW	Adds a new driver to the list and opens the Tree view for its configuration
DELETE	Deletes a driver from the list (it is not possible to delete Carlo Gavazzi's locked drivers)
EDIT	Edits a driver from the list (it is not possible to edit Carlo Gavazzi's locked drivers, nonetheless it is possible to copy a Carlo Gavazzi driver to a new one and edit the latter)
COMPILE	Compiles a driver, highlighting any errors or warnings
TEST	Starts the test function, aimed at checking that the compiled driver communicates with the connected meter according to expectations
COPY	Copies an existing driver to a new item in the list
IMPORT	Imports a driver file (XML format) exported by the MDE tool
EXPORT	Exports a driver file in XML format

14.3.3 Drivers' status in the MDE LIST view

Status	Description
EDITING	The driver is being edited, but it has not been compiled with successful result
COMPILED	The driver has been compiled with successful result; it is not available for connecting meters to VMU-C
REJECTED	The driver has been compiled with errors; errors must be corrected before retrying to compile it again
ACTIVE	The driver has been successfully compiled and activated; now it is available for being used to connect meters in VMU-C

14.3.4 MDE Tree view

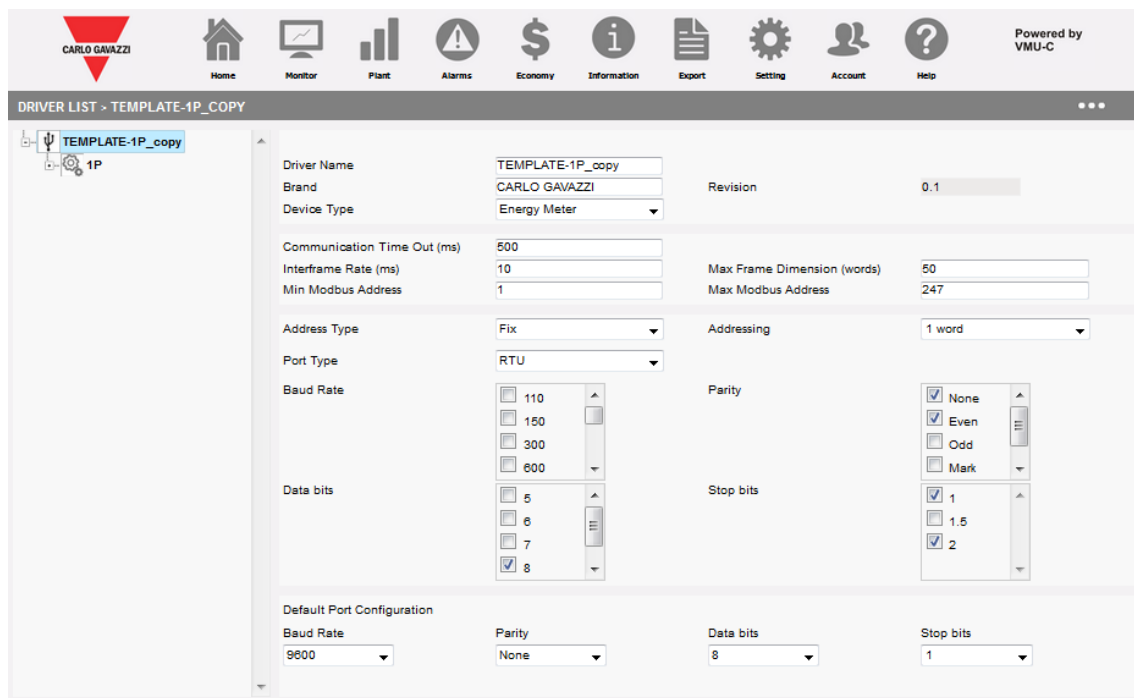

The MDE tree view allows to:

- Navigate the driver's tree
- Configure the relevant parameters according to the current focus

The available hierarchy levels are the following ones:

Level	Description
DRIVER	Root level. Here the main parameters of the field bus connection are defined
CONFIGURATION	Any pattern meant as set of groups of variables which identifies a specific mode of operation of the target meter
GROUP	Any group of variables with a logical link between them (i.e. in the case of multi-meters, any single meter is a group)

Level	Description
VARIABLE	Any single variable in the relevant group; MODBUS register settings, scales, ranges, validation rules are defined at this level
TREND	Any trend definition based on the available set of variables to be embedded in the driver; the TREND will be available for whatever VMU-C using the driver

14.4 Using the MDE

14.4.1 Creating a driver

A new driver is created by means of the NEW driver function, in the contextual menu, from the LIST view. Once the new Driver is created, the MDE switches to the TREE view to allow configuring the relevant parameters.

A list of drivers templates is presented to the user while creating a new driver; the template is compiled by VMU-C according to the target driver of choice so as to define the correct set of variables.

14.4.2 Deleting a driver

An existing driver may be deleted by the relevant DELETE action in the context menu. Only user created drivers can be deleted. Drivers created by Carrro Gavazzi as part of the firmware distribution cannot be deleted.

14.4.3 Copying a driver

An existing driver can be copied to a new instance; a new driver is created inheriting the complete configuration of the original one. When a driver is copied, a new driver's branch is created and the versioning system will track versions starting from scratch.

14.4.4 Building a driver

An existing driver can be built by means of the BUILD DRIVER action available in the context menu. The BUILD action checks the driver's definition for mistakes, and compiles the driver structure by taking into account the correct Modbus frame configuration. If any error is found by the BUILD action, the process exits without building a driver, and errors and warnings are reported to the user.

14.4.5 Exporting a driver

```
<?xml version="1.0" encoding="UTF-8"?>
<E0S_driver xmlns:xsi="http://www.w3.org/2001/XMLSchema-instance" xsi:noNamespaceSchemaLocation="driver_schema.xsd">
  <general>
    <driver_id>729862703746</driver_id>
    <name>EM210</name>
    <brand>CUSTOM</brand>
    <driver_version>1.7</driver_version>
    <protocol>0</protocol>
    <instrum>EM210</instrum>
    <instrum_code>0</instrum_code>
    <data_max_size>10</data_max_size>
    <extraoption1></extraoption1>
    <extraoption2></extraoption2>
    <notes></notes>
    <imgsmall></imgsmall>
    <imgbig></imgbig>
    <autoscan>0</autoscan>
    <code_address>0</code_address>
    <errskipthres>3</errskipthres>
    <errskipcount>5</errskipcount>
    <driver_date>1435334809</driver_date>
    <idtypeLabel>0</idtypeLabel>
    <adresstype>2</adresstype>
    <slvaddrtype>0</slvaddrtype>
  </general>
  <configurations>
    <configsnum>1</configsnum>
    <configuration>
      <idDrvConfig>1</idDrvConfig>
      <name>3P</name>
      <groupsnum>1</groupsnum>
      <group>
        <idDrvGroup>1</idDrvGroup>
        <category>2</category>
      </group>
    </configuration>
  </configurations>
</E0S_driver>
```

By this function it is possible to export the driver as an XML formatted file. The file is now available for being imported in another VMU-C EM unit powered by A9 (or more updated) firmware version.

14.4.6 Testing a driver

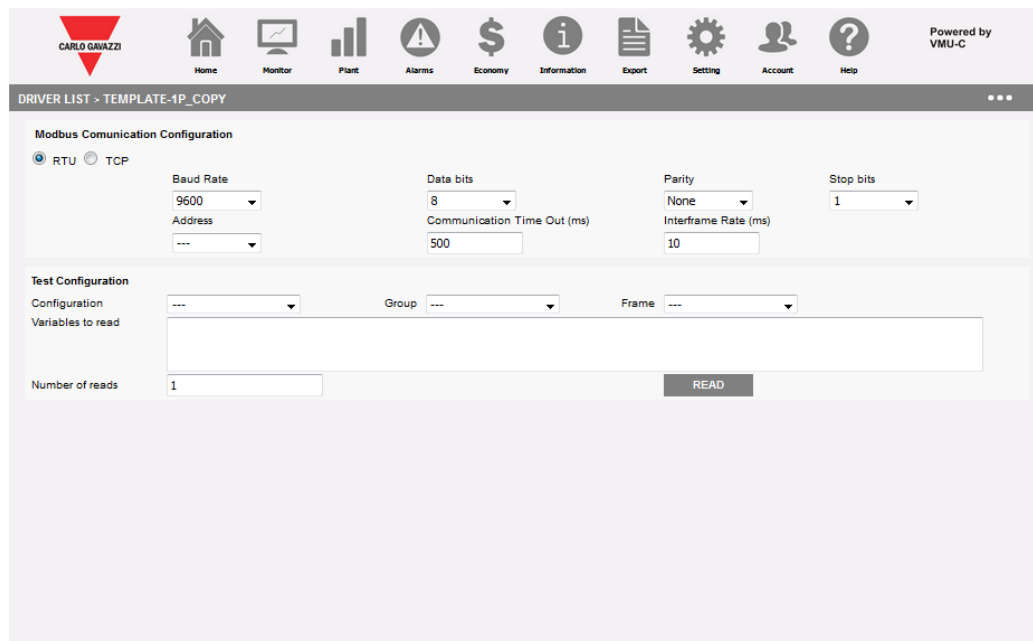

An existing driver can be tested without activating it, by using the relevant testing function. The testing function allows to interactively test a Driver of choice by reading on demand the desired Modbus frames with the variables of choice. The result of a single or multiple read actions is available as summary statistics (highlighting communication errors) and contents of the last read frame. Variable values are available both in decimal and hexadecimal format, both in standard and swapped format .

14.4.7 Configuring communication parameters

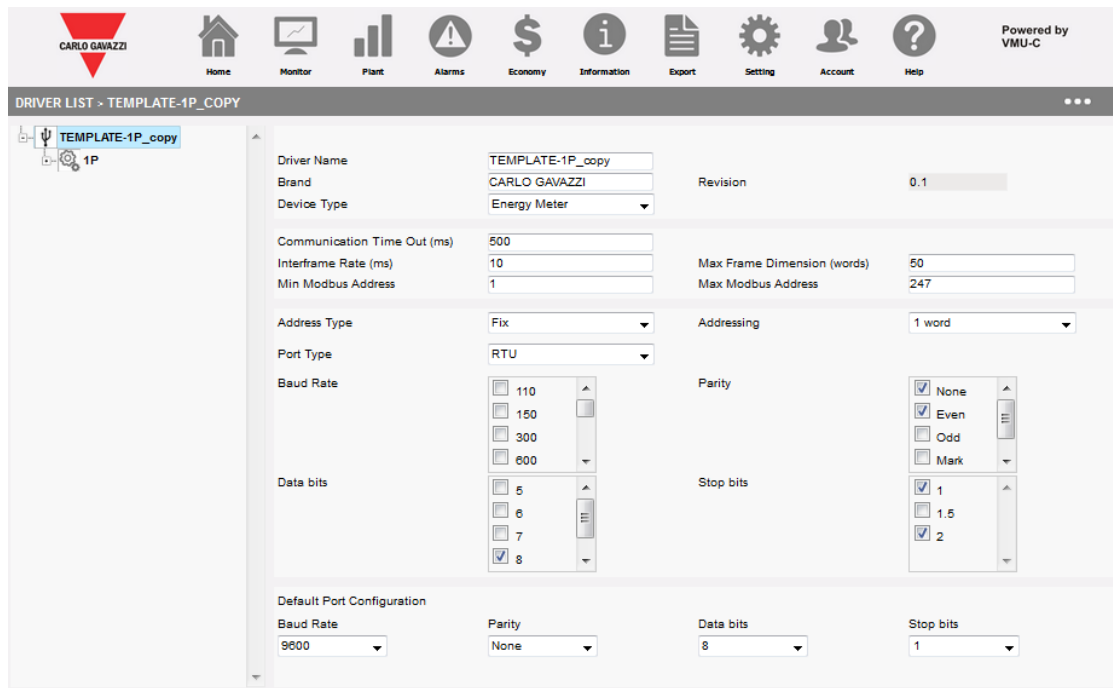

The first step while editing a driver, is configuring the relevant communication parameters.

The available parameters are:

Parameter	Description	Notes	TCP/RTU
Driver name			Both
Brand			Both
Device type			Both
Revision	Driver's revision	Updated automatically by the Modbus tool after a successful compilation	Both
Communication time out	Time out time after which a time-out exit status is raised	Default 500 ms	Both
Interframe rate	Time interval between 2 Modbus frame readings		Both
Max Frame Size(Words)	It is the size of the frame in words	The tool splits the mapping in frames according to this parameter	Both
Min/Max Address	Range of available Modbus address	Some Modbus devices allow a restricted set of Modbus addresses	Both
Address type	Fixed = valid for most cases Consecutive = valid for devices which embed multiple subdevices with consecutive Modbus	The default choice (Fixed) is the right one in most cases	Both

Parameter	Description	Notes	TCP/RTU
	addresses Free = valid for devices which embed multiple subdevices with free Modbus addresses		
Address size	1 Byte 1 Word 2 Words		Both
Port type	RTU TCP		Both
Baud rate	Range of allowed baud-rate values		RTU
Parity	Range of allowed parity values		RTU
Data bits	Range of allowed data bits values		RTU
Stop bits	Range of allowed stop bits values		RTU

14.4.8 Adding/editing/deleting/saving a configuration

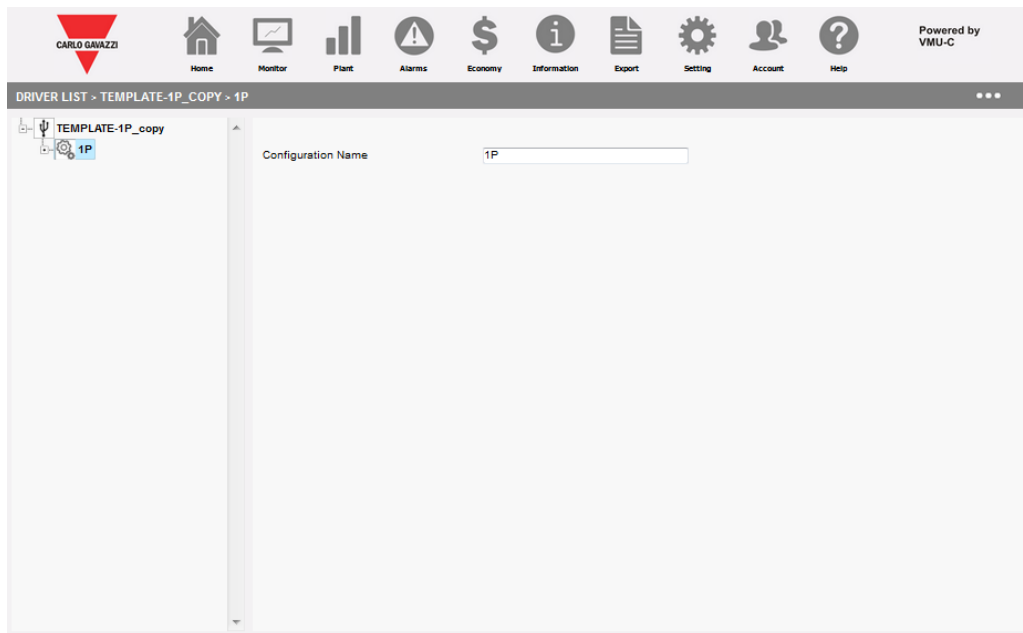

Configurations are different working modes in the same meter. Some meters may have different working modes, which allow them to work in 3-phase or 1-phase systems. For this reason the same driver may contain different configurations which are relevant to different working modes.

It is possible by this section of the interface to add, edit, save and delete a configuration. The configuration is a container and its only parameter is its name.

14.4.9 Adding/editing/deleting/saving a group

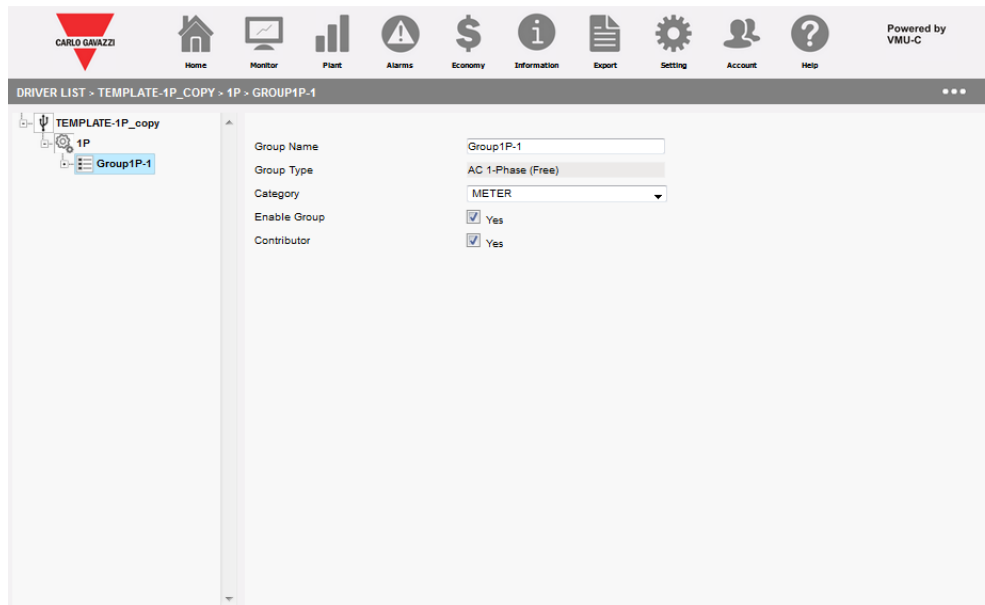

Configurations are sets of variables in the same configuration. Some meters may have different groups, usually corresponding to a sub-meter, in the same configuration. It is possible by this section of the interface to add, edit, save and delete a group.

The configuration is a container of variables and the available parameters are:

Parameter	Description	Notes
Group name		
Group type	Generic AC 1-phase(free) AC 1-phase (fixed) AC 1-phase(L1) AC 1-phase(L2) AC 1-phase (L3) AC 3-phase DC	Generic groups are meant for variables which are not from either AC or DC meters
Category	METER: meter variables (default choice) SYSTEM: System variables (in the case of meters with multiple groups dedicated to single phases and one group with the system variables) SUM: meter variables meant as a sum of the other sub-meters (groups)	Only for AC or DC meters
Enable		
Contributor	Indicates if the group contributes or not to the totalizing functions of VMU-C (to avoid adding the same contribution twice in the case of SUM groups)	

14.4.10 Adding/editing/deleting/saving a variable

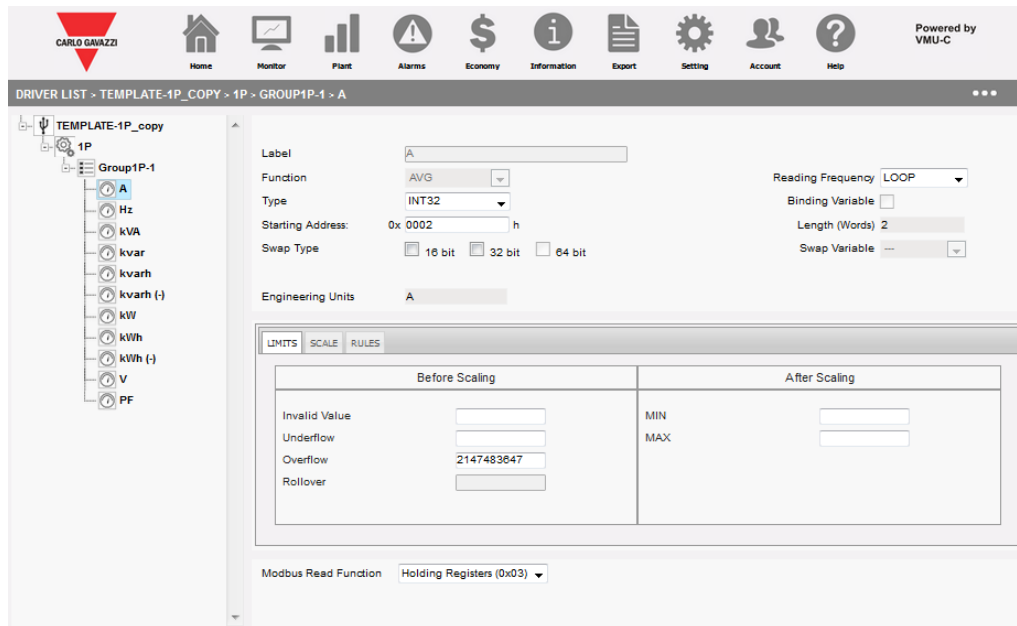

By this section it is possible to add/edit/save/delete a variable, which is always contained in a group.

There are two groups of settings, the header on the TOP and the tabs on the bottom.

14.4.10.1 Header parameters

Parameter	Description	Notes
Label	Variable name	
Function	Function to be applied to samples in the VMU-C's sampling time interval	
Type	Modbus variable type	
Starting address	Initial hex address of the target variable	
Swap Type	Any combination of swaps at 16/32/64 bit level	
Reading frequency	LOOP : for variables ONCE: for register to be read only at the VMU-C start-up	
Binding variable	Variable to be Binded to in the case of conditioned scaling (see TAB section)	
Length(Words)	Field length	
Swap variable	Variable conditioning the swapping (SWAP is applied if the variable is not zero)	

14.4.10.2 TABS parameters

Tab	Parameter	Description	Notes
-----	-----------	-------------	-------

Limit	Invalid value	Special Hex value indicating invalid reading	
Limit	Underflow	Special Hex value indicating Underflow	
Limit	Overflow	Special Hex value indicating Overflow	
Scale		Scaling formula, allowing to define whatever combination of registers to calculate a variable on the basis of different registers (e.g. reading + scaling)	
Rules	Rules list	List of configured rules	
Rules	If VALUE is:	Operator to be used to evaluate the condition	
Rules	TO/THAN	Value to be checked	
Rules	Then CONVERT TO:	Result of the evaluation	
Rules	Apply rule after formula calculation	The rule is applied after the scaling (by default it is applied before)	
Limit (after scaling)	MIN(engineering unit)	Minimum value	
Limit (after scaling)	MAX(engineering unit)	Maximum value	
Limit (after scaling)	Rollover(engineering unit)	Rollover value	

14.4.11 Adding/editing/deleting/saving a Trend

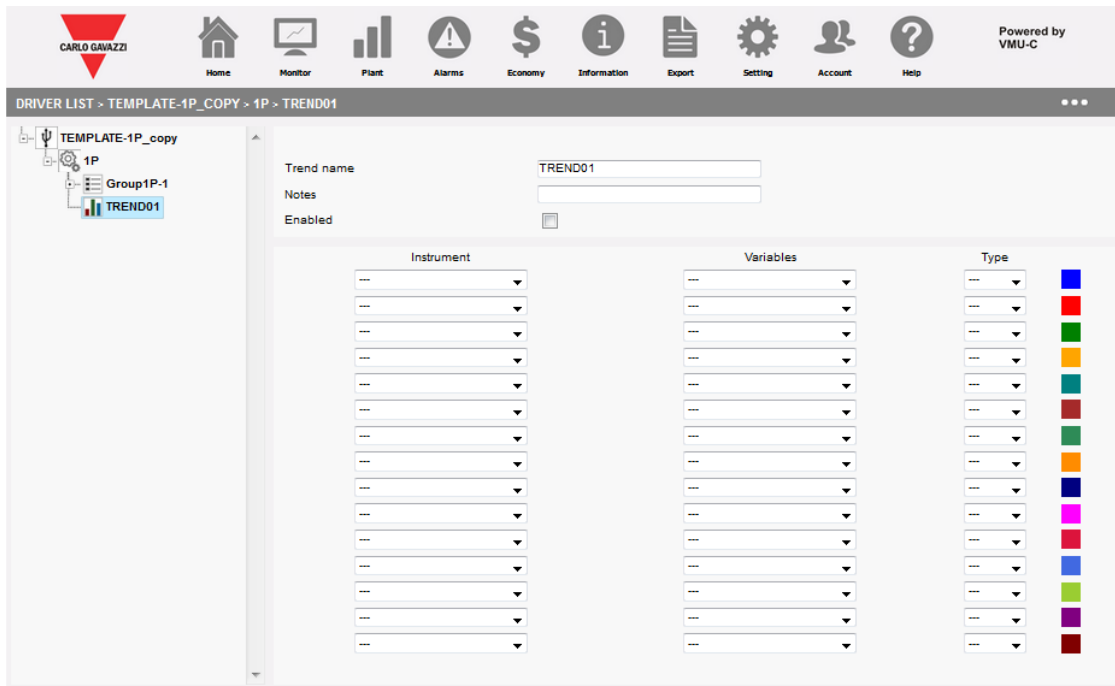

It is possible to link one or more TRENDS to a driver; a Trend is a set of variables from one or more groups which are displayed at the same time in the same trend chart; by

VMU-C

linking a trend to a driver, the trend itself will be immediately available for being used without any need to be configured afterwards.

The available parameters are:

Parameter	Description	Notes
Trend name		
Notes		
Enabled		
Group	Container group for the target variable	
Variable	Target variable	
Type	Average Max Min	VMU-C stores 3 series for each variable, maximum, minimum and average

15 USER INTERFACE CUSTOMIZATION

15.1 ABSTRACT

Starting from VMU-C EM firmware release A10, the user can customize parts of the VMU-C's user interface, so as to adapt it to his needs.

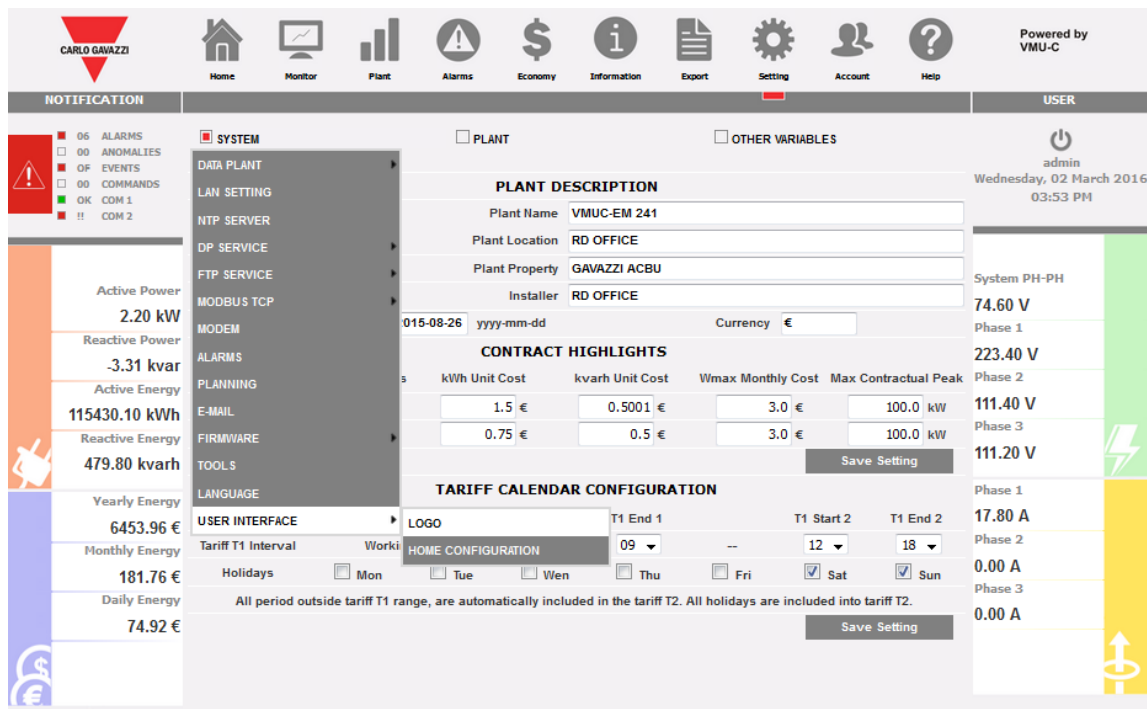

User interface customization

There are 2 features available to customize the user interface:

- Logo
- Home configuration

The former allows to change the company logo in the user interface web pages and in the login and update pages; the latter allows administrators to change the home page according to the needs.

See the sections:

- Logo customization
- Home configuration

for further details.

15.2 LOGO CUSTOMIZATION

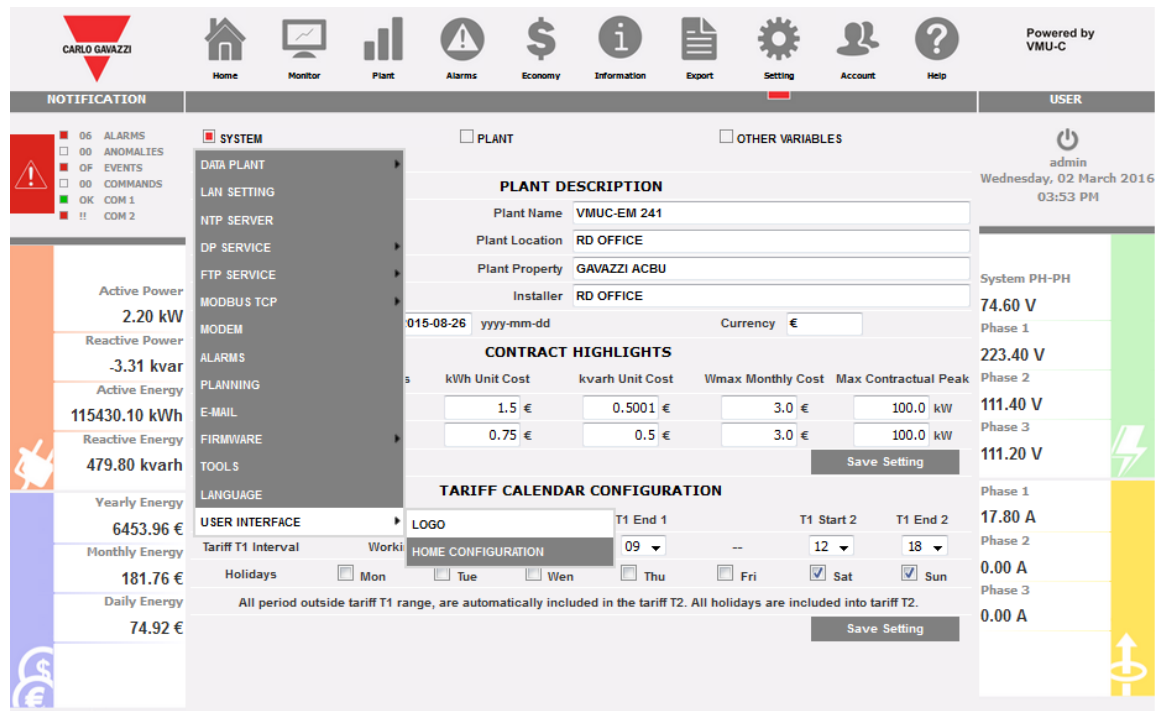

Logo customization

This feature is available under the menu displayed in the above picture.

This function allows to upload a picture file in different formats:

File format	Max size (kB)	Dimensions
PNG	250	Min.: 300x224 Max.:455x340
JPG	250	Min.: 300x224 Max.:455x340
SVG	250	No limits

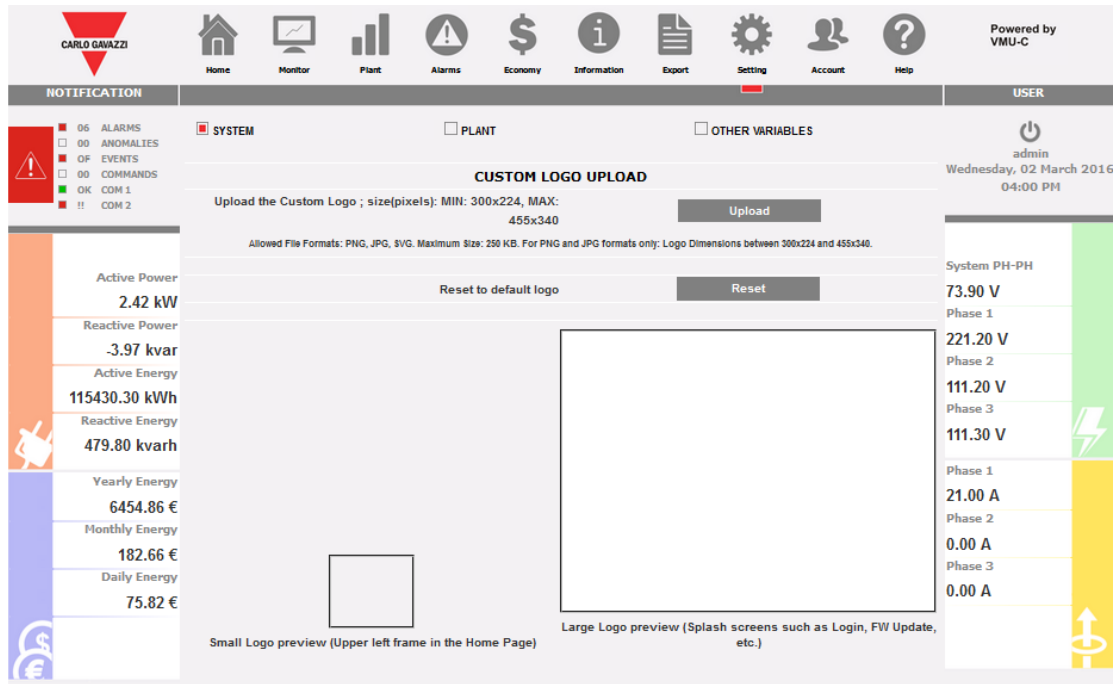

Logo customization

Two preview boxes are available to check the results both for small logo (ordinary web pages) and the large logo (login and firmware update screens).

The available actions are:

Action	Interface control	Description
UPLOAD	UPLOAD pushbutton	The logo picture is uploaded and displayed in the preview boxes
RESET	RESET pushbutton	The logo is reset to the standard Carlo Gavazzi's one

15.3 HOME CONFIGURATION

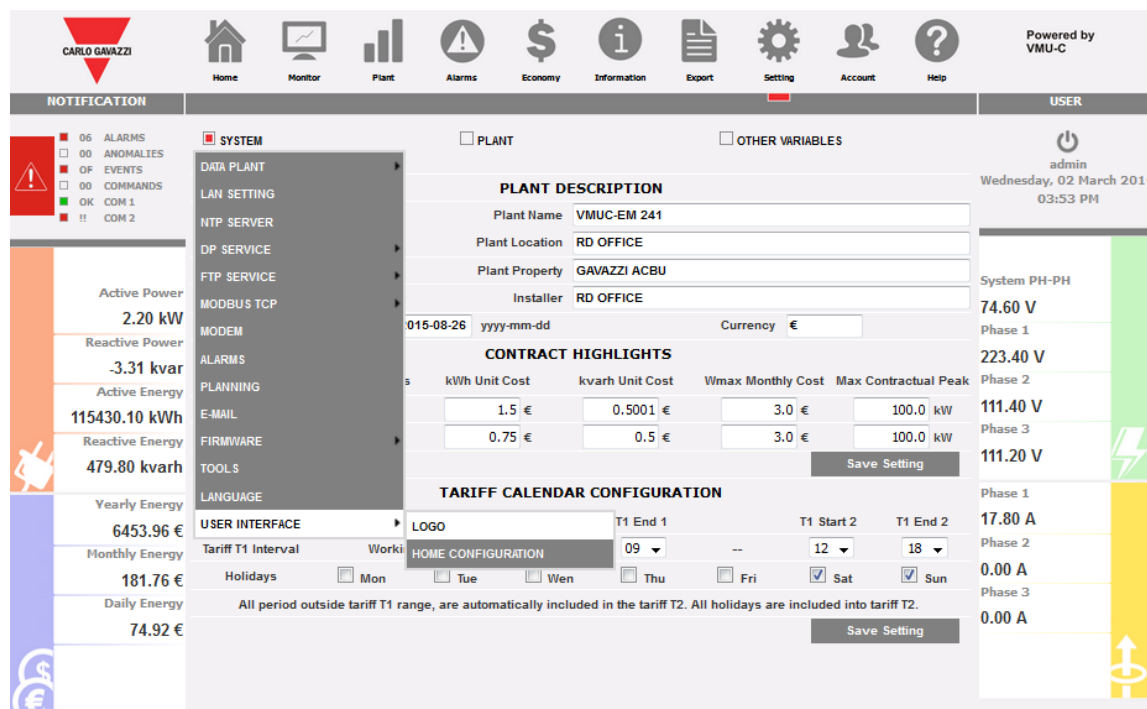

Logo customization

This feature is available under the menu displayed in the above picture.

This function allows to select the HOME Page contents out of the following choices:

Selection	Description	Notes
Load Profile	Chart displaying the main meter daily consumption graph, comparing the today's profile Vs. the yesterday's one	
Trends	Chart displaying one TREND created by means of the specific function in the PLANT menu	By means of this selection it is possible to display whatever combination of variables in the HOME page
Energy Summary	Table view displaying daily, monthly, yearly consumption data for a selected list of meters	See the relevant ENERGY SUMMARY function in the PLANT menu

Logo customization

The available actions are:

Action	Interface control	Description
SAVE	SAVE pushbutton	Saving the present selection
Home Page Selector	3 choices check box	Selecting the desired choice among: LOAD PROFILE TRENDS ENERGY SUMMARY

16 IOT functions

16.1 Abstract

VMU-C is provided with integration functions in specific IoT ecosystems. Here are the relevant notes.

16.2 VMU-C is MICROSOFT AZURE CERTIFIED FOR IOT.



The purpose of this manual is not to describe the functions and use of the functions of Microsoft Azure IoT, described in the relevant documents available online.

The purpose of this manual is to describe how VMU-C integrates in such system. Information about the certification of VMU-C are available at this link: [https://catalog.azureiotsuite.com/details?title=VMUCEMAWSSUX&source=homepage\[catalog.azureiotsuite.com\]](https://catalog.azureiotsuite.com/details?title=VMUCEMAWSSUX&source=homepage[catalog.azureiotsuite.com])

16.2.1 Connection to MICROSOFT AZURE IOT.

In the menu Settings/System, go to the item Microsoft Azure IoT. The parameter setup screen is displayed:

Connection parameters to Microsoft Azure IoT

The available fields are:

Field	Description
Enable Service	It enables the data push service on the IoT HUB
Service Status	Displays the state of the service: <ul style="list-style-type: none"> Green = OK Red = disconnected
Start from	Enables to set the first date from which historic data retrieval starts
Last Data Push	Indicates the date/time of the latest data packet sent
Connection string	Enables to enter the connection string to the IoT HUB portal
Upload time Interval	Enables to indicate the interval between two data transmissions to the IoT HUB
Meter and Record selection	Enables to select the meters and the record types included in the data sent to the IoT HUB

Once the parameters are correctly set and saved, you can test the connection with the specific button.

When the service is active, all the data collected by VMU-C and saved in the database starting from the selected date is sent to the portal using the secure protocol MQTT.

Collected data is sent each time the preset interval expires.

Once available within Microsoft Azure for IoT, the data can be used with the tools available in that platform.

17 DATACENTER APPLICATIONS

17.1 Introduction and field of application

VMUC EM provides specific functions for Datacenter applications.

The functions in question are available in conjunction with the Carlo Gavazzi meters of the ET272 series. These functions can be used in data centres and in installations which include:

- 1) A common bus bar three-phase power supply line
- 2) Down conductors carrying the loads (the server cabinets, in the case of data centres), arranged according to a serial sequence

If the above conditions are met, you can automate the process of identifying the meters and pairing them with the correct Modbus address, reducing installation time by up to 90%, by jointly using:

- A) ET272 meters to monitor the individual down conductors
- B) VMUC-EM to collect the data of all the ET272 meters connected to the same series/bus bar

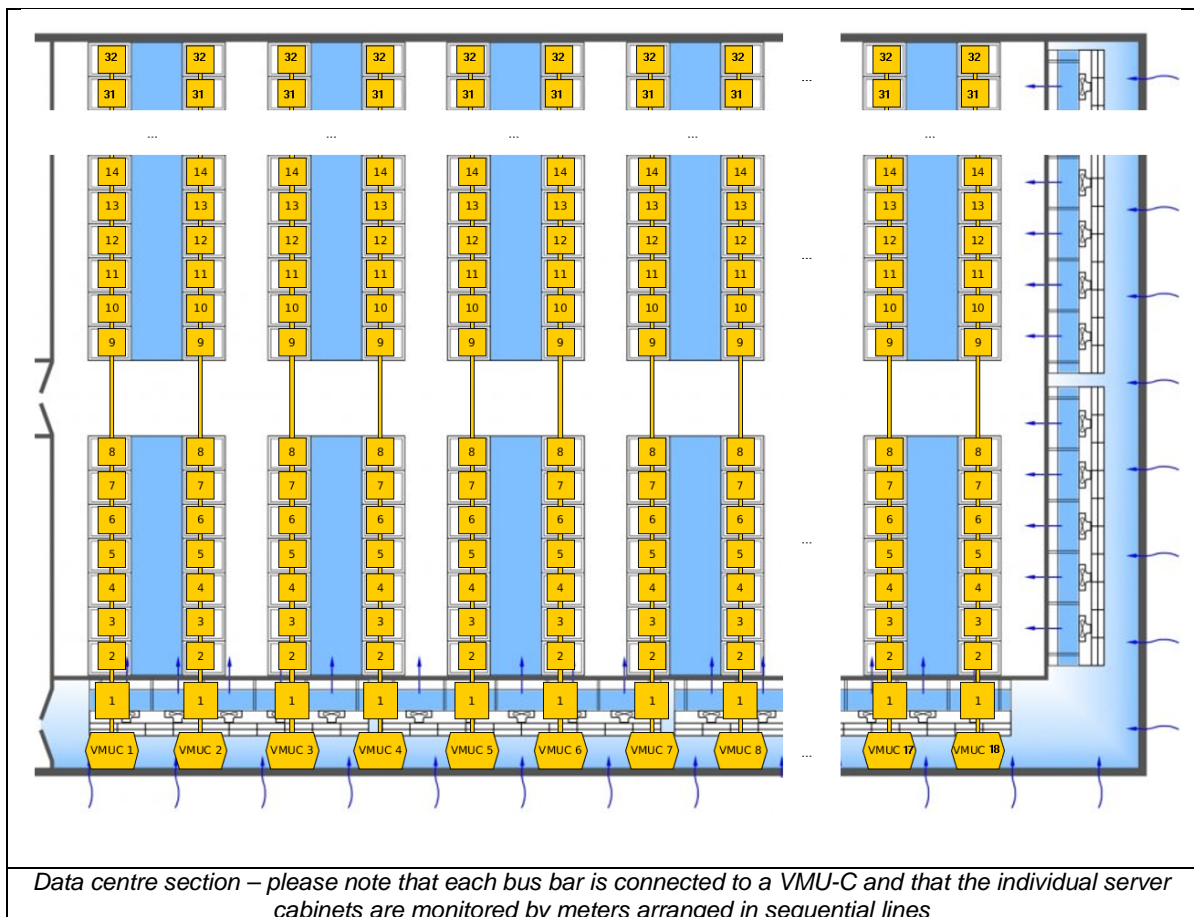

In applications of this kind it is critical to reduce the system installation time, considering that in these environments the use of bus bars requires horizontal and vertical displacements, that by their nature take a long time.

17.2 The solution

The solution is based on 3 elements:

- 1) The ET272 meters; you will have to install one of them for each down conductor, as each meter can monitor up to 6 single-phase loads
- 2) The VMUC EM, serving as data collector for each bus bar; all measurements performed by the ET272 meters are collected via RS485 by the VMUC EM, and converted into MODBUS/TCP, on a map made available by the VMUC EM through Ethernet
- 3) The data acquisition system, that acquires the measurements collected by the VMUC EM through the monitoring LAN

This way measurements flow along a hierarchical and easily configurable structure

System configuration is based on the following principles:

- a) Meters can be grouped according to ordered sequences
- b) Each meter has a unique identifier (SIN)
- c) A procedure allows to pair the unique identifier (SIN) with the Modbus address of the meter and with its position

The procedure requires that:

- A) When physically installing the system, the installer can easily draw up a ordered list on paper, in which the sequential position is paired with the unique identifier of the meter
- B) When configuring the system from the VMUC interface the physical sequential position can be easily paired with the Modbus address and with the unique identifier.

Important note: the solution is based on the joint use of VMUC EM and of ET272 meters; no other meter from Carlo Gavazzi or any other manufacturer must be installed on the RS485 line, as it might jeopardise the system operation.

17.3 Preconditions

For proper commissioning and configuration the following conditions must be met:

- 1) Only ET272 meters and the VMUC must be connected to the RS485 line
- 2) No other meter must be connected to the VMUC; the Datacenter procedure is for exclusive use
- 3) Before proceeding with the configuration stage, the installer must have filled in the COMMISSIONING LIST with the labels containing the SINS of the ET272 meters
- 4) A PC connected to the VMUC via LAN or WAN must be available
- 5) A barcode reader operating in keyboard emulation mode (optional) must be available

17.4 Paper list drawing up stage

The labels with the SIN codes of the ET272 meters are included in the supply; for information about their use please refer to the user manual of the ET272 meter.

It is important that once installation is completed there exist a paper list with the labels arranged in the correct sequential order. This list shall serve as a guideline in the configuration stage.

The Web interface of the VMUC provides a function allowing to create a PDF template of the COMMISSIONING LIST, that once printed shall serve as a matrix for the list in question.

Plant	VMUC		
Plant Location	nd		
Plant Property	nd		
Installer	nd		
VMU-C Installation Date	2013-01-01		

Slave	SIN Address	Description	Label
1			
2			
3			
4			
5			

Abstract from the COMMISSIONING LIST template that can be printed from VMUC

17.5 User interface description

17.5.1 Fields of the table in the Datacenter function

Order	Selection	Locked	Slave Addr.	SIN	Description	Model	FW ver.	CT (TCDA1)	CT (TCDA2)	Configuration	L1	L2	L3	L4	L5	L6
1	<input type="checkbox"/>	<input type="checkbox"/>	1	XXX.XXX.XXX		ET272		Auto	Auto	3.1P	<input checked="" type="checkbox"/>	<input checked="" type="checkbox"/>	<input checked="" type="checkbox"/>	<input type="checkbox"/>	<input type="checkbox"/>	<input type="checkbox"/>
2	<input type="checkbox"/>	<input type="checkbox"/>	2	XXX.XXX.XXX		ET272		Auto	Auto	3.1P	<input checked="" type="checkbox"/>	<input checked="" type="checkbox"/>	<input checked="" type="checkbox"/>	<input type="checkbox"/>	<input type="checkbox"/>	<input type="checkbox"/>
3	<input type="checkbox"/>	<input type="checkbox"/>	3	XXX.XXX.XXX		ET272		Auto	Auto	3.1P	<input checked="" type="checkbox"/>	<input checked="" type="checkbox"/>	<input checked="" type="checkbox"/>	<input type="checkbox"/>	<input type="checkbox"/>	<input type="checkbox"/>
4	<input type="checkbox"/>	<input type="checkbox"/>	4	XXX.XXX.XXX		ET272		Auto	Auto	3.1P	<input checked="" type="checkbox"/>	<input checked="" type="checkbox"/>	<input checked="" type="checkbox"/>	<input type="checkbox"/>	<input type="checkbox"/>	<input type="checkbox"/>
5	<input type="checkbox"/>	<input type="checkbox"/>	5	XXX.XXX.XXX		ET272		Auto	Auto	3.1P	<input checked="" type="checkbox"/>	<input checked="" type="checkbox"/>	<input checked="" type="checkbox"/>	<input type="checkbox"/>	<input type="checkbox"/>	<input type="checkbox"/>
6	<input type="checkbox"/>	<input type="checkbox"/>	6	XXX.XXX.XXX		ET272		Auto	Auto	3.1P	<input checked="" type="checkbox"/>	<input checked="" type="checkbox"/>	<input checked="" type="checkbox"/>	<input type="checkbox"/>	<input type="checkbox"/>	<input type="checkbox"/>
7	<input type="checkbox"/>	<input type="checkbox"/>	7	XXX.XXX.XXX		ET272		Auto	Auto	3.1P	<input checked="" type="checkbox"/>	<input checked="" type="checkbox"/>	<input checked="" type="checkbox"/>	<input type="checkbox"/>	<input type="checkbox"/>	<input type="checkbox"/>
8	<input type="checkbox"/>	<input type="checkbox"/>	8	XXX.XXX.XXX		ET272		Auto	Auto	3.1P	<input checked="" type="checkbox"/>	<input checked="" type="checkbox"/>	<input checked="" type="checkbox"/>	<input type="checkbox"/>	<input type="checkbox"/>	<input type="checkbox"/>
9	<input type="checkbox"/>	<input type="checkbox"/>	9	XXX.XXX.XXX		ET272		Auto	Auto	3.1P	<input checked="" type="checkbox"/>	<input checked="" type="checkbox"/>	<input checked="" type="checkbox"/>	<input type="checkbox"/>	<input type="checkbox"/>	<input type="checkbox"/>
10	<input type="checkbox"/>	<input type="checkbox"/>	10	XXX.XXX.XXX		ET272		Auto	Auto	3.1P	<input checked="" type="checkbox"/>	<input checked="" type="checkbox"/>	<input checked="" type="checkbox"/>	<input type="checkbox"/>	<input type="checkbox"/>	<input type="checkbox"/>
11	<input type="checkbox"/>	<input type="checkbox"/>	11	XXX.XXX.XXX		ET272		Auto	Auto	3.1P	<input checked="" type="checkbox"/>	<input checked="" type="checkbox"/>	<input checked="" type="checkbox"/>	<input type="checkbox"/>	<input type="checkbox"/>	<input type="checkbox"/>
12	<input type="checkbox"/>	<input type="checkbox"/>	12	XXX.XXX.XXX		ET272		Auto	Auto	3.1P	<input checked="" type="checkbox"/>	<input checked="" type="checkbox"/>	<input checked="" type="checkbox"/>	<input type="checkbox"/>	<input type="checkbox"/>	<input type="checkbox"/>
13	<input type="checkbox"/>	<input type="checkbox"/>	13	XXX.XXX.XXX		ET272		Auto	Auto	3.1P	<input checked="" type="checkbox"/>	<input checked="" type="checkbox"/>	<input checked="" type="checkbox"/>	<input type="checkbox"/>	<input type="checkbox"/>	<input type="checkbox"/>
14	<input type="checkbox"/>	<input type="checkbox"/>	14	XXX.XXX.XXX		ET272		Auto	Auto	3.1P	<input checked="" type="checkbox"/>	<input checked="" type="checkbox"/>	<input checked="" type="checkbox"/>	<input type="checkbox"/>	<input type="checkbox"/>	<input type="checkbox"/>
15	<input type="checkbox"/>	<input type="checkbox"/>	15	XXX.XXX.XXX		ET272		Auto	Auto	3.1P	<input checked="" type="checkbox"/>	<input checked="" type="checkbox"/>	<input checked="" type="checkbox"/>	<input type="checkbox"/>	<input type="checkbox"/>	<input type="checkbox"/>
16	<input type="checkbox"/>	<input type="checkbox"/>	16	XXX.XXX.XXX		ET272		Auto	Auto	3.1P	<input checked="" type="checkbox"/>	<input checked="" type="checkbox"/>	<input checked="" type="checkbox"/>	<input type="checkbox"/>	<input type="checkbox"/>	<input type="checkbox"/>
17	<input type="checkbox"/>	<input type="checkbox"/>	17	XXX.XXX.XXX		ET272		Auto	Auto	3.1P	<input checked="" type="checkbox"/>	<input checked="" type="checkbox"/>	<input checked="" type="checkbox"/>	<input type="checkbox"/>	<input type="checkbox"/>	<input type="checkbox"/>
18	<input type="checkbox"/>	<input type="checkbox"/>	18	XXX.XXX.XXX		ET272		Auto	Auto	3.1P	<input checked="" type="checkbox"/>	<input checked="" type="checkbox"/>	<input checked="" type="checkbox"/>	<input type="checkbox"/>	<input type="checkbox"/>	<input type="checkbox"/>
19	<input type="checkbox"/>	<input type="checkbox"/>	19	XXX.XXX.XXX		ET272		Auto	Auto	3.1P	<input checked="" type="checkbox"/>	<input checked="" type="checkbox"/>	<input checked="" type="checkbox"/>	<input type="checkbox"/>	<input type="checkbox"/>	<input type="checkbox"/>
20	<input type="checkbox"/>	<input type="checkbox"/>	20	XXX.XXX.XXX		ET272		Auto	Auto	3.1P	<input checked="" type="checkbox"/>	<input checked="" type="checkbox"/>	<input checked="" type="checkbox"/>	<input type="checkbox"/>	<input type="checkbox"/>	<input type="checkbox"/>
21	<input type="checkbox"/>	<input type="checkbox"/>	21	XXX.XXX.XXX		ET272		Auto	Auto	3.1P	<input checked="" type="checkbox"/>	<input checked="" type="checkbox"/>	<input checked="" type="checkbox"/>	<input type="checkbox"/>	<input type="checkbox"/>	<input type="checkbox"/>
22	<input type="checkbox"/>	<input type="checkbox"/>	22	XXX.XXX.XXX		ET272		Auto	Auto	3.1P	<input checked="" type="checkbox"/>	<input checked="" type="checkbox"/>	<input checked="" type="checkbox"/>	<input type="checkbox"/>	<input type="checkbox"/>	<input type="checkbox"/>

Datacenter function - instrument table

Each table row represents a ET272 meter connected to the RS485 line.

Field	Description
Order	It represents the sequential order of the meter
Selection field	It allows to select one or more rows for later editing (see Action Menu)
Locked	It allows to lock a meter to ensure that it cannot be modified by scanning or manual editing
SIN	It represent the unique SIN address of the instrument
Description	It represents the description of the instrument, which is assigned by default but can be edited by the user
Model	It contains the instrument model detected by the scan
FW ver.	It contains the firmware release of the instrument detected by the scan
CT(TCDA1)	It represents the primary current of the current transformer 1 connected to the ET272; it has a user-specified value only in case TCDMMs are used; in the other cases detection is automatic (AUTO)
CT(TCDA2)	It represents the primary current of the current transformer 2 connected to the ET272; it has a user-specified value only in case TCDMMs are used; in the other cases detection is automatic (AUTO)
Configuration	It indicates the usage configuration of the ET272 meter: <ul style="list-style-type: none"> 3.1P (one three-phase meter, one CT) 6.1P (two three-phase meters, two CTs)
L1,L2,L3,L4,L5,L6	It allows to enable the requested phases; by default L1,L2,L3 are enabled and configuration is 3.1P; you can also manage cases in which configuration is 6.1P, but only one phase is assigned (e.g.: L4)

17.5.2 Colour code of the Datacenter function rows

The colour code of the rows in the Datacenter function table (where, we remind you, each row corresponds to a meter), is the following:

Colour	Meaning	Ready to RUN
Green	Meter configured, found by scan and validated	Yes
Yellow	Meter found by scan, but not configured yet	No
Red	Meter in error (not found by scan or invalid)	No
Orange	Meter found, but not present in the initial configuration of the project	No
Blue	Serious SIN addressing problem: please contact the Carlo Gavazzi technical support service	No
Purple	CT configuration to be verified or TCD not connected	No

The following sample figure shows a screenshot with the result of a scan:

	<input type="checkbox"/>	Locked	Slave Addr.	SIN	Description
1	<input type="checkbox"/>		1	137.072.255	TOB_137.072.255_1
2	<input checked="" type="checkbox"/>		2	137.073.000	TOB_137.073.000_2
3	<input type="checkbox"/>		3	137.073.001	TOB_137.073.001_3
4	<input checked="" type="checkbox"/>		4	137.073.002	TOB_137.073.002_4
5	<input checked="" type="checkbox"/>		5	137.073.003	TOB_137.073.003_5
6	<input type="checkbox"/>		6	137.073.004	TOB_137.073.004_6
7	<input type="checkbox"/>		7	137.073.005	TOB_137.073.005_7
8	<input type="checkbox"/>		8	137.073.006	TOB_137.073.006_8
9	<input type="checkbox"/>		9	XXX.XXX.XXX	
10	<input type="checkbox"/>		10	XXX.XXX.XXX	
11	<input type="checkbox"/>		11	XXX.XXX.XXX	
12	<input type="checkbox"/>		12	XXX.XXX.XXX	
13	<input type="checkbox"/>		13	XXX.XXX.XXX	
14	<input type="checkbox"/>		14	XXX.XXX.XXX	
15	<input type="checkbox"/>		15	XXX.XXX.XXX	
16	<input type="checkbox"/>		16	XXX.XXX.XXX	
17	<input type="checkbox"/>		17	XXX.XXX.XXX	
18	<input type="checkbox"/>		18	XXX.XXX.XXX	
19	<input type="checkbox"/>		19	XXX.XXX.XXX	
20	<input type="checkbox"/>		20	XXX.XXX.XXX	
21	<input type="checkbox"/>		21	XXX.XXX.XXX	
22	<input type="checkbox"/>		22	XXX.XXX.XXX	

Sample Datacenter table screenshot

17.5.3 Action Menu of the Datacenter function

The Action Menu of the Datacenter function allows the user to execute a series of actions, described below.

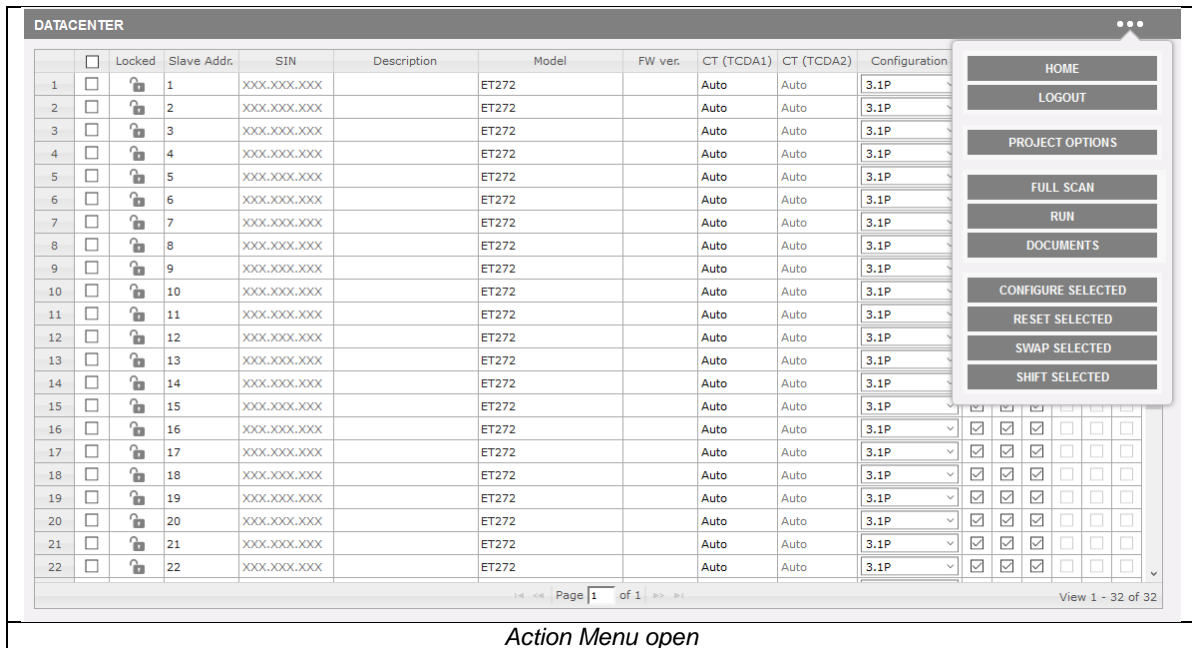

Action	Description
HOME	It returns to the HOME PAGE
LOGOUT	It performs the user LOGOUT
PROJECT OPTIONS	It allows to modify the project options: <ul style="list-style-type: none"> • Number of ET272 meters connected • Starting address to be assigned in the scan
SCAN	It runs a full scan of the RS485 network
RUN	It performs a series of actions: <ul style="list-style-type: none"> • It applies to the ET272 meters the set configuration parameters • It writes the Modbus parameters edited from the user interface into the meters (including the Modbus address) • It activates the data logging function
DOCUMENTS	It allows to extract the project-related documents: <ul style="list-style-type: none"> • Instrument list (empty for label affixing or filled in at the end of the procedure) in PDF format • MODBUS/TCP map in PDF format • End-of-procedure instrument list, in XLS or CSV format
CONFIGURE SELECTED	It allows to alter the parameters that can be edited by the Datacenter procedure for the meters selected in the list
RESET SELECTED	It allows to reset the parameters of the meters selected in the list
SWAP SELECTED	It allows to swap the meters selected in the list
SHIFT SELECTED	It allows to shift the position of the meters selected in the list

Note: from the Datacenter function interface you can also use Drag'n Drop to move any items in the list and reorder them according to different criteria.

17.6 Commissioning procedure

17.6.1 Configuration function preparation

From the Web interface of the VMUC access the Datacenter menu item and start the function.

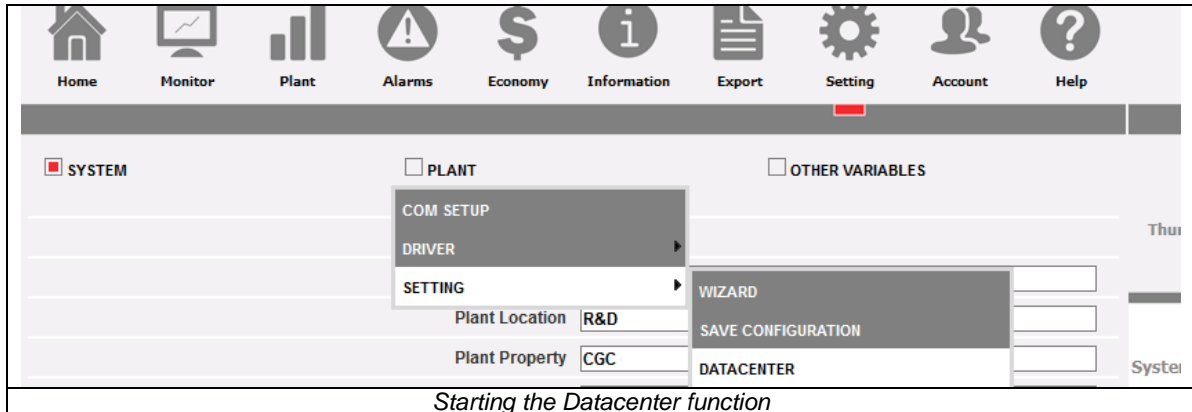

You must now define the project size, accessing the Action Menu at the top right and selecting PROJECT OPTIONS:

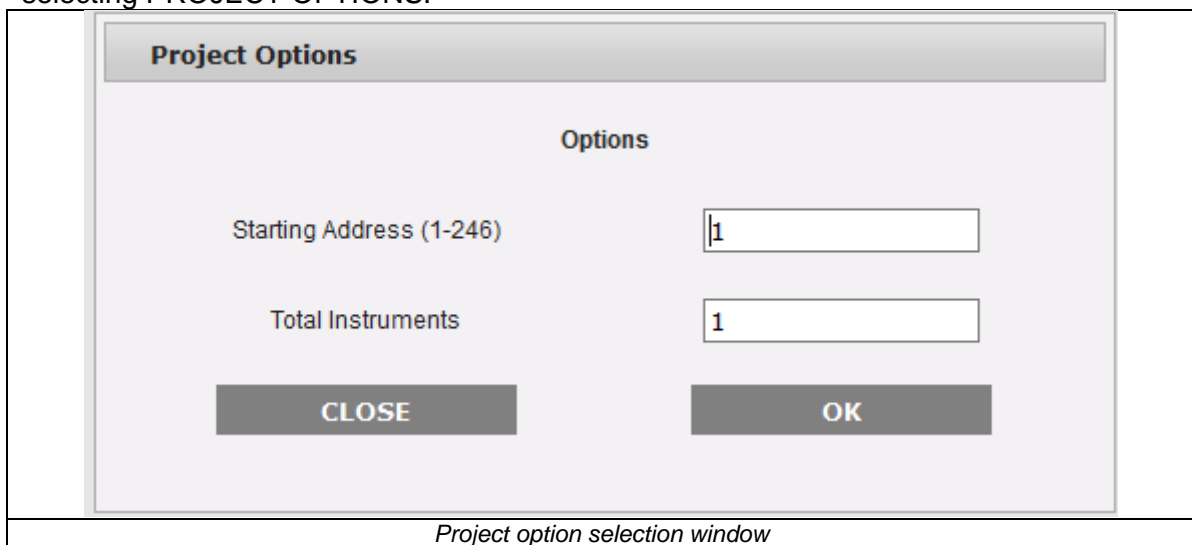

This screen allows to define:

- The MODBUS starting address of the first ET272 meter in the list.
- The total number of ET272 meters to be included in the project.

Now you can choose between 2 alternative procedures:

- 1) Entering the SINs through a barcode reader, then running a scan
- 2) Running a scan and then reordering the list

Note: For both options you must have the COMMISSIONING LIST complete with SIN barcodes, extracted and affixed in advance on the relevant sheet (see above). For information about the relevant procedure please refer to the ET272 meter commissioning manual.

17.6.2 Entering SINS through a barcode reader

To perform this procedure you must have a barcode reader, connected to the PC via USB and operating in keyboard emulation mode.

Responsibility for selecting the barcode reader, properly installing it and connecting it to the PC rests with the user and is outside the scope of this manual.

- 1) In the user interface, access the SIN field of the first instrument in the list.
- 2) Using the barcode reader read the content of the first ET272 meter label in the COMMISSIONING LIST
- 3) The SIN shall be written by the VMUC, and the cursor will move to the SIN field of the next row
- 4) Repeat steps 1,2,3 in the correct order, until the list is over

Now you can launch the scan from the VMUC, to validate the data entered using the barcode; the list content is compared with the result of the scan and any differences are highlighted by a colour code (please refer to the paragraph on the colour code of the table rows).

17.6.3 RS485 network scan

The VMUC EM provides a scanning function allowing to detect all the ET272 meters connected to the RS485 COM2 port of the VMUC, when no MODBUS address is assigned to them. This function uses a Carlo Gavazzi proprietary protocol; as a consequence:

- All meters connected to the serial line must be ET272
- No other meters from Carlo Gavazzi or third-party manufacturers must be connected to the same RS485 serial line

To launch the scan you must use the Action Menu, selecting the FULL SCAN function:

The screenshot shows the 'DATACENTER' interface with a table of 22 instrument rows. Each row contains columns for 'Locked', 'Slave Addr.', 'SIN', 'Description', 'Model', 'FW ver.', 'CT (TCDA1)', 'CT (TCDA2)', and 'Configuration'. The 'SIN' column contains placeholder text 'XXX.XXX.XXX'. An 'Action Menu' is overlaid on the right side of the table, containing buttons for 'HOME', 'LOGOUT', 'PROJECT OPTIONS', 'FULL SCAN', 'RUN', 'DOCUMENTS', 'CONFIGURE SELECTED', 'RESET SELECTED', 'SWAP SELECTED', and 'SHIFT SELECTED'. Below the table, there is a page indicator 'Page 1 of 1' and a view indicator 'View 1 - 32 of 32'. The text 'Action Menu open' is centered below the screenshot.

Once launched, the function shall detect all the ET272 meters connected to the network, indicating their SIN.

Note: If you use the scan function, the system assigns the Modbus address according to a FIFO pattern (first SIN found, first Modbus address assigned); the physical position in

the list and the corresponding Modbus address depend on the criteria applied by the user.

We strongly recommend that you use the same criteria to assign the physical position and the Modbus address, as this makes it easier to avoid errors.

In case of pre-assignment made using a barcode reader, the correct sequence is given at the start.

If the sequence is not given at the start, the user will have to reorder the devices using the meter shifting functions.

17.6.4 Activating the data reading mode

After the list has been completed and validated from the WEB interface:

- a) the colour of all rows is yellow or orange,
- b) the onscreen order matches the COMMISSIONING LIST order

you can launch the RUN mode from the Action Menu.

The RUN mode performs the following operations:

- 1) It turns the row colour to green if no error is detected (otherwise it assigns a colour in accordance with the above-mentioned table)
- 2) it writes the onscreen parameters into the ET272 meters (including the MODBUS address, corresponding to the position in the list)
- 3) it switches the VMU-C to data reading mode

Once the RUN mode is activated. The VMUC reads the measurement data from the ET272 meters, and makes them available on the Ethernet interface with Modbus/TCP protocol. The mapping is available as a PDF document in the DOCUMENTS list in the Action Menu.

17.7 Filing of commissioning documents

The following documents are available in the DOCUMENTS section of the Action Menu:

- 1) Meter list with parameters in CSV format
- 2) Meter list with parameters in XLS format
- 3) Commissioning list with or without parameters in PDF format
- 4) Modbus/TCP map in PDF format

Once extracted, the documents can be filed.

17.8 Subsequent editing of parameters

After switching the system to data reading (RUN) mode, you can:

- a) Change the position of the ET272 meters, and thus their order and Modbus address in the table
- b) Add or delete ET272 meters
- c) Edit the configuration parameters of the ET272 meters in the table

After each change you will have to perform a system validation:

- a) Launch the scan if new meters have been added or any SINS have been replaced
- b) Launch RUN

While you are making the changes the VMUC logs the data according to the configuration saved during the last RUN.

Once the RUN command is issued, the VMUC switches to data reading mode according to the new configuration; the MODBUS/TCP map is automatically adapted.

17.9 Modbus/TCP map

The Modbus/TCP map output by the Datacenter procedure has the structure shown below; this map has no link with the map available when using the VMUC outside the Datacenter procedure, as the 2 operating modes are mutually exclusive.

The map has a fixed layout, to make it easier for the Modbus/TCP controlling the system to acquire it, and avoid having to rewrite the master mapping each time any change is made.

Available systems:

- **3.1P** (default, only TCD1 is connected to ET272)
 - SYS_A, L1_A, L2_A, L3_A
- **6.1P** (both TCD1 and TCD2 are connected to ET272)
 - SYS_A, L1_A, L2_A, L3_A,
 - SYS_B, L1_B, L2_B, L3_B

Available variables:

- A L1, A L2, A L3
- V L1-L2, V L1-N, V L2-L3, V L2-N, V L3-L1, V L3-N,
- V L-L sys, V L-N sys (calculated by VMU-C)
- kW L1, kW L2, kW L3, kWsysA, PF sysA
- A L4, A L5, A L6 (only if TCD 2 is in use), otherwise the relevant registers contain the value 0xFEFEFEFE
- kW L4, kW L5, kW L6, kWsysB, PF sysB (only if TCD 2 is in use), otherwise the relevant registers contain the value 0xFFFFFFFF.
- kWh A TOT, kWh L1, kWh L2, kWh L3
- kWh B TOT, kWh L4, kWh L5, kWh L6, (only if TCD 2 is in use), otherwise the relevant registers contain the value 0xFFFFFFFF.
- The mapping always contains all the variables; if for any reason (meter reading error) the variable is not available, it contains the INVALID VALUE marker (0xFEFEFEFE.)
- Note:
 - 0xFFFFFFFF= value not available
 - 0xFEFEFEFE= invalid value

VMU-C