



NRG EtherNet/IP™ User Manual

Operating instructions

Manuale d'istruzioni

Betriebsanleitung

Manuel d'instructions

Manual de instrucciones

Brugervejledning

Table of Contents

- 1. Introduction 2
 - 1.1 Foreword 2
 - 1.2 Scope 2
 - 1.3 Disclaimer 2
 - 1.4 Warning notice system 2
 - 1.5 Qualified personnel 2
 - 1.6 Abbreviations and acronyms 3
 - 1.7 Other documents 3
 - 1.8 Disposal 3
- 2. Description 4
 - 2.1 System overview 4
 - 2.2 System components 4
- 3. Installation 6
 - 3.1 System configuration 6
 - 3.2 Connection Diagrams 7
 - 3.3 Load connection diagrams 8
 - 3.4 Auto- addressing 9
 - 3.5 Grounding 10
- 4. EtherNet/IP Configuration 11
 - 4.1 Importing the EDS file in Studio 5000 Logix Designer V31 11
 - 4.2 Adding the NRG-EIP to a project in Studio 5000 Logix Designer V31 13
 - 4.3 Start-up Parameters 16
- 5. Communication 19
 - 5.1 Exclusive Owner Connection – Implicit Messaging 19
 - 5.2 Input Only Connection – Implicit Messaging 19
 - 5.3 Explicit Messaging 21
 - 5.3.1 Standard CIP object classes 21
 - 5.3.2 Vendor specific object classes 27
- 6. Functions 30
 - 6.1 Functions overview 30
 - 6.2 Switching modes 30
 - 6.3 Measurements 35
- 7. Alarms and Diagnostics 36
 - 7.1 LED indications – NRG Controller 36
 - 7.2 LED indications – RG..N 36
 - 7.3 Alarms – NRG Controller 37
 - 7.4 Alarms – RG..N 38
- 8. Service and Maintenance 41
 - 8.1 Internal bus communication check 41
 - 8.2 Replacing an RG..N 41
 - 8.3 Using the NRG system without ‘REF’ terminal connection 42

1. Introduction

1.1 Foreword

The NRG described hereafter is a sub-system made up of a number of solid state relays intended for the switching of heaters in a machine. The solid state relays in this system are able to communicate with the main controller through an NRG controller that facilitates communication between the solid state relays and the main controller. The NRG controller is available for various communication interfaces including PROFINET, EtherNet/IP and Modbus RTU. Through this communication, it is possible for the main controller to control each solid state relay, read measurements related to each specific solid state relay and to identify specific failure modes related to the solid state relay or its associated heater load.

1.2 Scope

This manual is intended to provide information about the functionalities that are provided by the NRG system, explains set-up and configuration procedures, provides recommendations for use and gives a troubleshooting guide.

Should there be any problems that cannot be solved with the information provided in this guide, contact your Carlo Gavazzi sales representative for further assistance.

1.3 Disclaimer

Carlo Gavazzi accepts no liability for any consequence resulting from inappropriate, negligent, incorrect installation or adjustment of parameters of the equipment. Nor can Carlo Gavazzi assume liability for recommendations that appear or are implied in the following description. The information in this document is not considered binding on any product warranty.

The contents of this guide are believed to be correct at the time of publishing. In the interests of commitment to a policy of continuous development and improvement, Carlo Gavazzi reserves the right to change the specification of the product or its performance, or the contents of this guide without prior notice.

1.4 Warning notice system

The symbols indicated below are used throughout this guide to indicate a particularly important subject or information on safety instructions, configuration and installation of the products covered by this guide.

It is strongly recommended that this guide is read thoroughly before using the products and that safety related recommendations are followed.



Danger

Indicates that death, severe personal injury or property damage will result if proper precautions are not taken.



Warning

Indicates actions that if not observed may lead to damage of the products.



Information

Indicates general information related to the proper use of the products.

1.5 Qualified personnel



The product / system described in this documentation may be operated only by personnel qualified for the specific task that are also capable of identifying risks and avoid potential hazards when working with these products.

The NRG system features dangerous voltages and consequently failure to observe the instructions contend in this user manual may cause serious harm to people and damage to property.

1.6 Abbreviations and acronyms

Acronyms	
RG..N / RG..CM..N / End device	NRG Solid state relays
RGx1A..CM..N	NRG zero cross switching solid state relay
NRGC..	NRG Controller
COM	Common
PLC	Programmable Logic Controller
SSR	Solid State Relay

1.7 Other documents

Datasheets, installation guide, certificates and other relevant documentation can be found online at www.gavazziautomation.com

1.8 Disposal



	<p>Information for users on the correct handling of waste of electrical and electronic equipment (WEEE)</p> <p>With reference to European Union directive 2002/96/EC issued on 27 January 2003 and the related national legislation, please note that:</p> <ul style="list-style-type: none"> • WEEE cannot be disposed of as municipal waste and such waste must be collected and disposed of separately • the public or private waste collection systems defined by local legislation must be used. In addition, the equipment can be returned to the distributor at the end of its working life when buying new equipment • the equipment may contain hazardous substances: the improper use or incorrect disposal of such may have negative effects on human health and on the environment • the symbol (crossed-out wheeled bin) shown on the product or on the packaging and on the instruction sheet indicates that the equipment has been introduced onto the market after 13 August 2005 and that it must be disposed of separately • in the event of illegal disposal of electrical and electronic waste, the penalties are specified by local waste disposal legislation.
--	--

2. Description

2.1 System overview

The NRG is a sub-system that consists of one or more BUS chains that interact with the main controller or PLC in the machine through an Ethernet/IP communication interface. The communication link in the NRG systems can either be used to control the solid state relay, monitor various parameters, and diagnose faults in real time.

An NRG BUS chain is made up of a minimum 1x NRG controller and a minimum of 1x NRG solid state relay (also referred to as end-device). The NRG bus chain can have a maximum of 32 end devices. The communication link between the NRG controller and the end-devices is the Internal BUS.

When more solid state relays are needed in a system, multiple BUS chains can be utilised. Each BUS chain connects to another BUS chain in a line topology via the NRG controllers of the respective BUS chains or in a star topology via an ethernet switch.

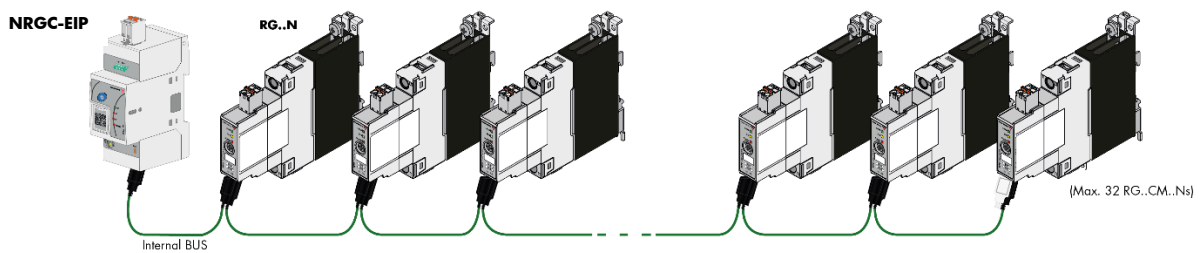

Figure 1: NRG bus chain

2.2 System components

The following system components are required for an NRG bus chain:

Description	Part number	Notes
NRG controller	NRGC..	<p>NRGC NRG Controller with Modbus RTU.</p> <p>NRGC-PN NRG controller with PROFINET.</p> <p>NRGC-EIP NRG controller with Ethernet/IP™.</p> <p>NRGC-ECAT NRG controller with EtherCAT.</p> <p>NRGC-MBTCP NRG controller with Modbus TCP.</p> <p>1x RGN-TERMRES is included in the NRGC.. packaging. The RGN-TERMRES is to be mounted on the last RG..N on the bus chain.</p>
NRG solid state relays	RG..CM..N	<p>RGx1A..CM..N NRG zero cross switching solid state relay</p> <p>RGx1P..CM..N NRG proportional switching solid state relay</p>
NRG Internal bus cables	RGCR-GN-xx	Proprietary cables terminated at both ends with micro USB connector

NRG controller

The NRG controller handles the communication with the higher-level controller and with the NRG solid state relays. It has to be supplied with a 24VDC supply and provides the power supply to the connected NRG solid state relays via the internal bus cables. A termination resistor (RGN-TERMRES) provided with every NRG controller has to be fitted on the last solid state relay of the NRG bus chain. The NRG controller is also capable of performing internal operations to setup and maintain the internal bus



Various NRG Controller variants are available which facilitate communication via different communication protocols. These are identified via the part numbers. The NRG controller with an EtherNet/IP communication interface is the **NRGC-EIP**.

NRG solid state relays

The RG..N solid state relays are the switching components in the NRG system. They are available with and without heatsink. For a reference of the variants available refer to the RG..N datasheet. The RG..CM..N utilises the communication system for switching, measurement and diagnostic thus minimising the number of components required in the system. There are 2 variants of the RG..CM..N, the RGx1A..CM..N is the zero cross relay including various switching modes such as ON/OFF, Burst, Distributed full cycle and Advanced full cycle modes. The RGx1P..CM..N is the proportional control variant which on top of the aforementioned switching modes includes also phase angle switching and soft starting features. For more information on the functions of each variants refer to Section 6.



Through the internal BUS, the main controller can read measurement parameters and diagnostics information related to the RG..N and its load. The RG..N is also capable of detecting certain fault conditions. A fault condition is indicated through a red LED available on the façade of the RG..N. The type of fault can be identified through a specific flash rate of the red LED and identified via the communication system.

Since the main controller needs to address each specific RG..N individually, each RG..N needs to be uniquely identifiable. It is not required to physically set the ID for each RG..N. This can be done through an auto-addressing function which occurs automatically on the first start up; whereby each RG..N on the bus chain will automatically be assigned an ID with respect to its physical placement on the internal bus.

NRG internal cables

The RCRGN-xxx-2 is a 5-way proprietary cable used for the internal BUS, i.e., between the NRG controller and the first RG..N on the BUS chain and between respective RG..Ns on the BUS. This internal BUS cable though terminated with a micro-USB plug is not a standard USB cable. Apart from the data and supply lines, the RCRGN-xxx-2 are equipped with an additional wire utilised for the auto-addressing of the RG..Ns on the NRG bus chain. These cables are available in various lengths from Carlo Gavazzi.



For further technical information on each NRG system component please refer to the respective product datasheets:

System component	Datasheet	QR Codes
NRGC-EIP	https://gavazziautomation.com/images/PIM/DATASHEET/ENG/SSR_NRGC_EIP.pdf	
NRGC-PN	http://gavazziautomation.com/docs/mt_gh/SSR_NRGC_PN.pdf	
RG..CM..N	http://gavazziautomation.com/docs/mt_gh/SSR_RG_CM_N.pdf	
RCRGN-xxx-2	http://gavazziautomation.com/docs/mt_gh/SSR_RG_CM_N.pdf	

3. Installation



Installation general requirements

Avoid installing the device in environments with the following characteristics:

- relative humidity higher than 95% or with condensation;
- strong vibrations or shocks;
- exposure to water sprays;
- exposure to aggressive and polluting atmospheres (e.g.: sulphur and ammonia fumes, saline mist, smoke) to avoid corrosion and/or oxidation
- strong magnetic and/or radio frequency interference (thus avoid installation near transmitting antennae)
- exposure of the devices to direct sunlight and the elements in general.

3.1 System configuration

The NRG bus chain consists of 1 NRG controller and up to 32 NRG solid state relays. The NRG controller is the interface to the main controller via the 2xRJ45 shielded communication ports. The connection between the NRG controller and the solid state relays is through the internal bus cables. Each RG..N is equipped with 2x micro USB ports to allow looping between one RG..N and another using the RGCGN-xx-2 bus cables from Carlo Gavazzi. The RGN-TERMRES supplied with each NRG controller has to be connected to the last RG..N on the NRG bus chain.

The NRG controller has to be supplied with a 24VDC via the supply input plug (Us-, Us+). Power to the RG..Ns on the bus chain is provided via the internal bus cables through the NRG controller.

The RG..Ns require a mains reference connection with respect to the load (neutral or another phase) through the 'Ref' connector to provide voltage and power measurements. The Ref connector has 2x internally shorted terminals to allow for looping of the mains reference onto various RG..Ns. Refer to 'Load connection diagrams' section for more information.

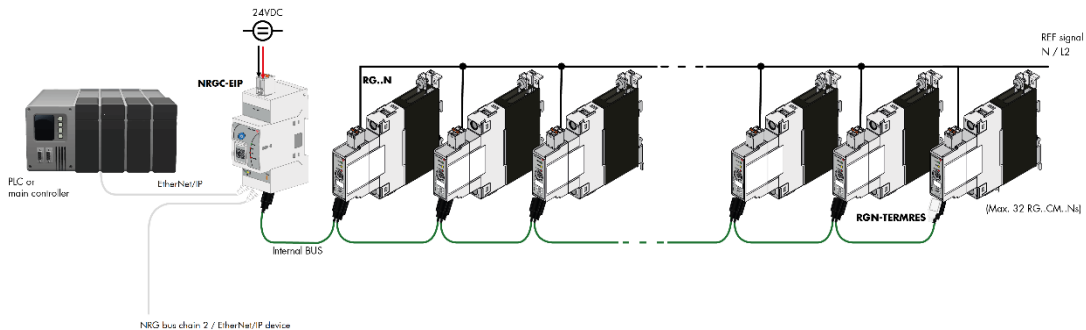

Figure 2 NRG bus chain configuration

3.2 Connection Diagrams

The NRG bus chain can be connected to the ethernet network via the pair of RJ45 connectors located on the NRG controller. The NRG can be configured in any network topology. If more than 32 solid state relays are required in an application, multiple bus chains can be utilised. These can be configured in a line or star topology as deemed fit for the application. Wiring between EtherNet/IP devices should follow the standard EtherNet/IP cabling guidelines.

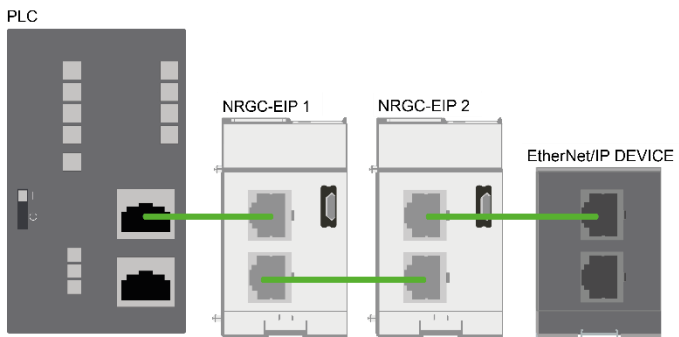

Figure 3 NRG bus chains connected in a line EtherNet/IP topology

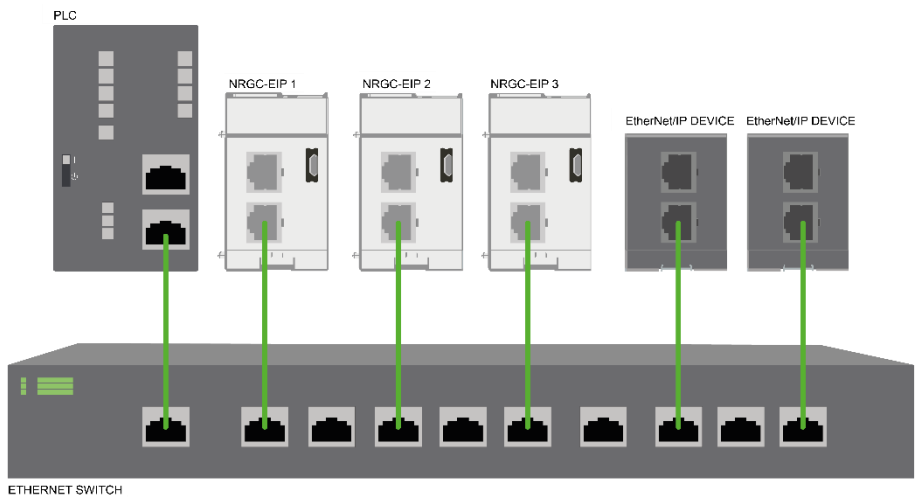

Figure 4 NRG bus chain connected in a star EtherNet/IP network

The NRG Controller supports the Device Level Ring (DLR) protocol and therefore can also be configured in a ring topology. The NRG Controller is not a Ring Supervisor but acts as a Beacon-Based Ring Node (i.e., a non-supervisor node).

3.3 Load connection diagrams

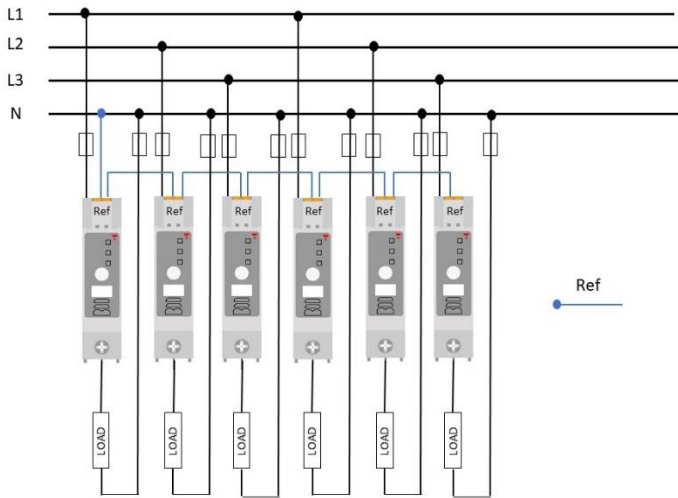

Figure 5 Loads connected between phase and neutral. The Ref connections can be looped from one RG..CM..N to another since all the loads have the same return path

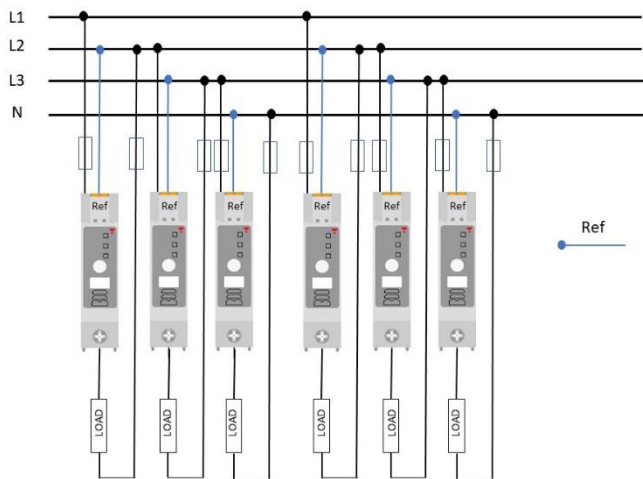

Figure 6 Loads connected between phases. Reference connection (Ref) should always follow the return path of the load

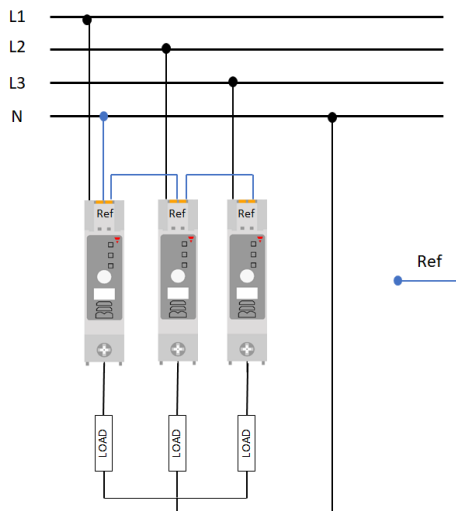

Figure 7 The NRG solid state relay can be utilised with 3-phase loads having a star with neutral configuration. The reference connections (Ref) can be looped from one RG..CM..N to another and

3.4 Auto- addressing

The RG..Ns on the bus chain are automatically addressed upon the initial start-up of the system. The RG..Ns are addressed based on their position on the bus chain.

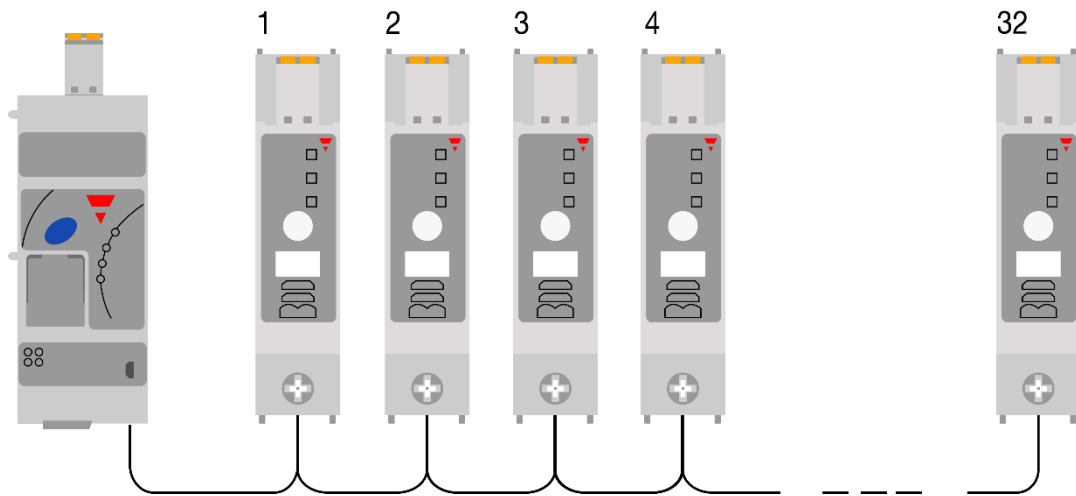

Figure 8 SSRs in NRG bus chain are automatically addressed based on their position on the bus

In case of an RG..N replacement, or any changes to the NRG bus chain, the RG..Ns have to be readdressed. Follow the procedure below (Figure 9) to readdress the RG..Ns on the NRG bus chain manually. Alternatively, auto-addressing can also be performed digitally, check Communications section for further information.

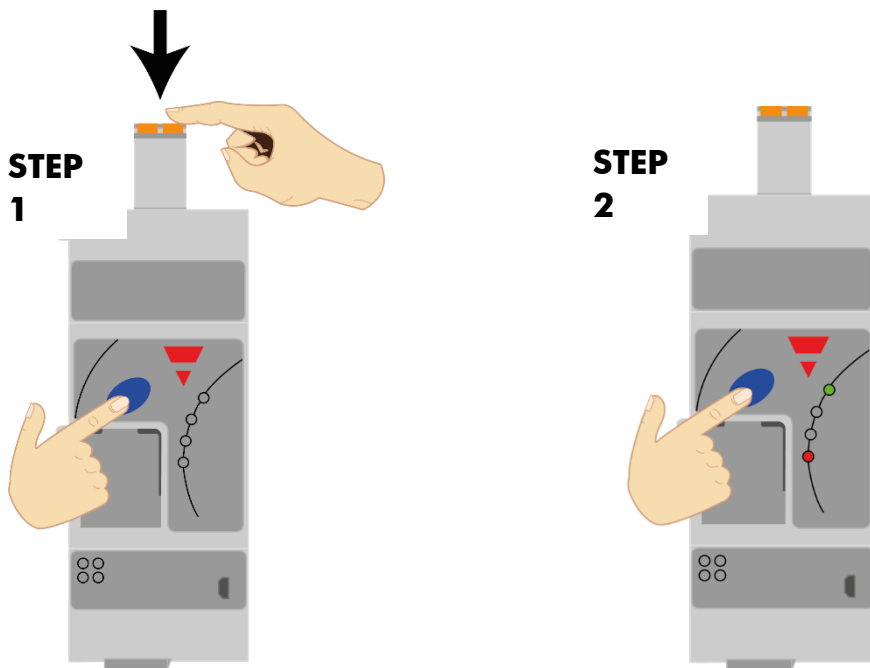

Figure 9 Manual Auto addressing procedure

STEP 1: Hold the blue button while inserting the power supply plug of the NRG-C-EIP

STEP 2: Release the blue button once the Alarm LED turns ON

3.5 Grounding

Connecting the protective ground for the NRG Controller

The NRG controller is equipped with a metal contact clip at the back of the product to provide functional grounding via the Din Rail. The Din Rail must be conductive and grounded. Shielded Cat 5e cables fitted with an outer metallic shell should be used. The shell should be connected to the wire screen of the cable.

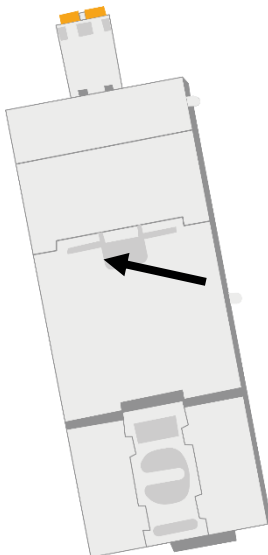

Figure 10 Metal din clip on NRG controller for functional grounding

Connecting the protective earth for the NRG solid state relays

The heatsink of the RGC..Ns has to be earthed via the connection provided using an M5 screw. Note that the M5 Protective Earth (PE) screw is not provided with the RG..N.

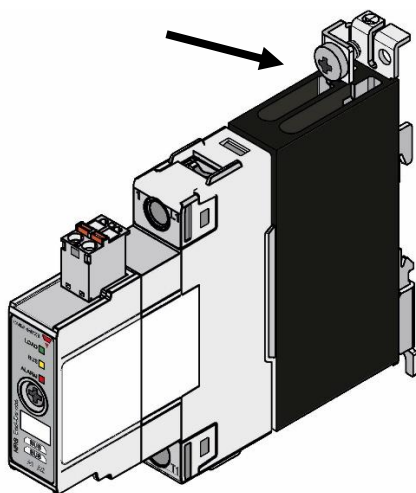
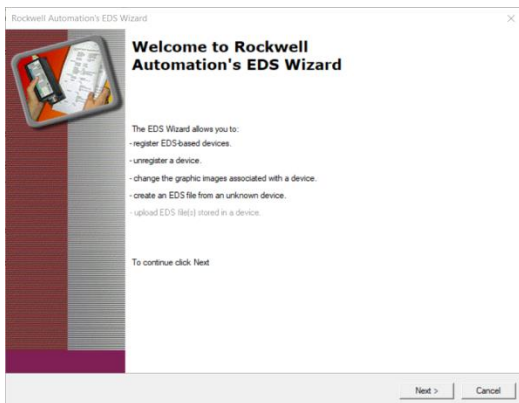

Figure 11 RG..N connection for Protective Earth

4. EtherNet/IP Configuration

4.1 Importing the EDS file in Studio 5000 Logix Designer V31

1. Open the EDS Hardware Installation Tool from **Tools -> EDS Hardware Installation Tool**. Press 'Next'.



2. Select 'Register an EDS file(s)' from the **Options** dialog window and press 'Next'.

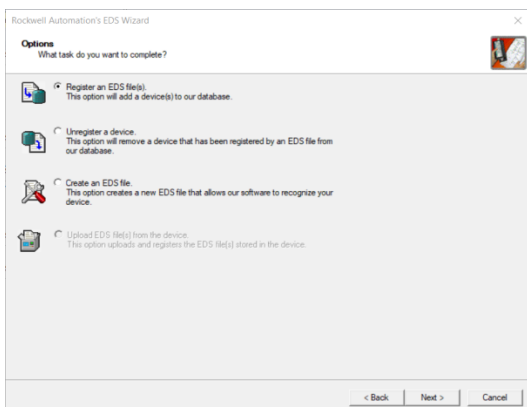

3. On the **Registration** dialog box, check the 'Register a single file' option and select the EDS file to install by clicking the 'Browse' button to select the required file. Press 'Next'.

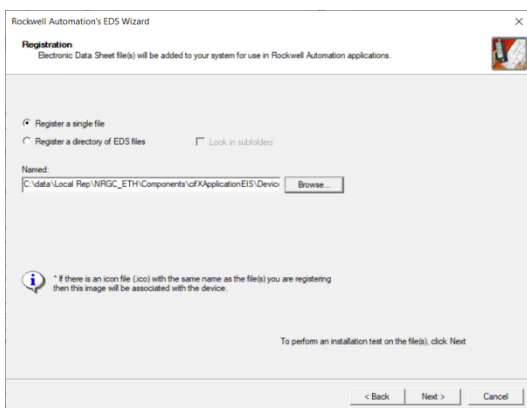

4. A similar message to the below should show up in the next dialog box. Press 'Next'.

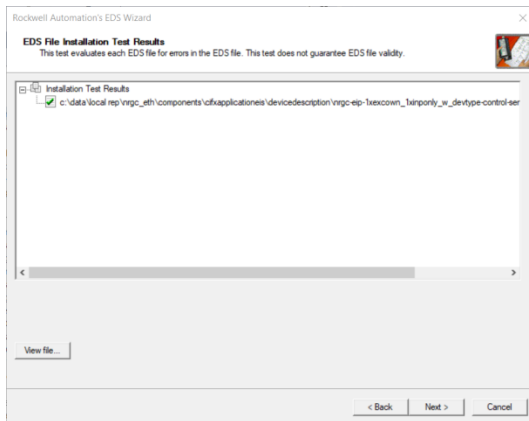

5. Press 'Next' for the following 2 dialog boxes (Note: an image icon is currently not defined in the EDS file).

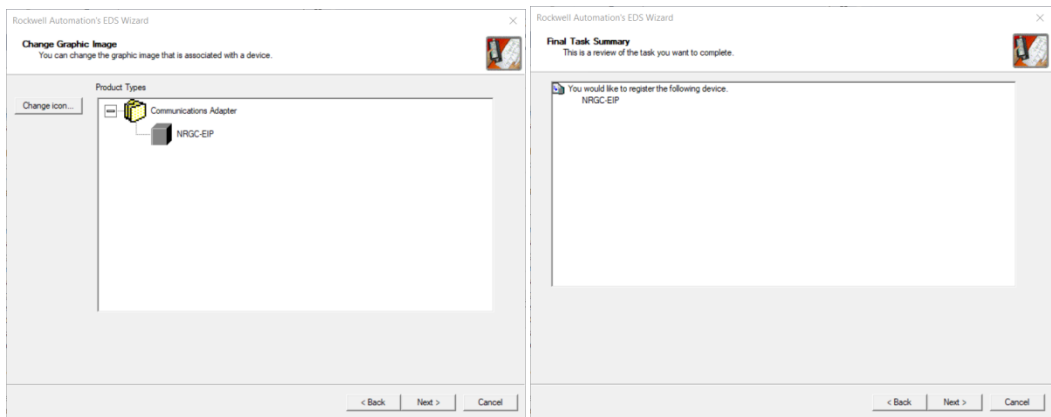

6. Press the 'Finish' button to complete the task. After which the EDS file is installed and can be used to configure the NRG.

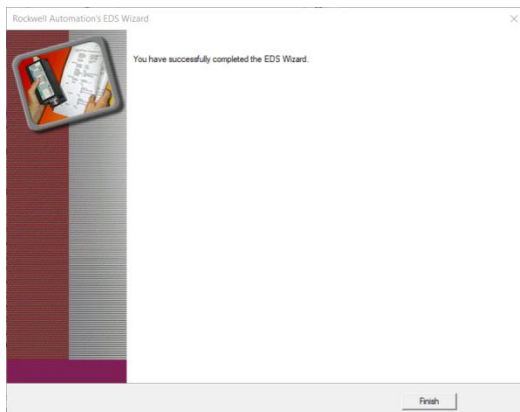

- Then click on the 'Change' button to set up the connections and the data size. There are multiple exclusive owner and input only connections to choose from. For an NRG bus chain made up of 1-pole RG..Ns, the standard Exclusive Owner and Input Only connections have to be selected

Name	Size
Exclusive Owner Connection - 5 x 3Phase End Devices (minimum)	Input: 5 x RGC2/3P + 3 x RGx1A/P Output: 5 x RGC2/3P + 3 x RGx1A/P
Exclusive Owner Connection	Input: 5 x RGC2/3P + 3 x RGx1A/P
Input Only Connection	Output: 0
Exclusive Owner Connection - 2 x 3Phase End Devices (minimum)	
Exclusive Owner Connection - 3 x 3Phase End Devices (minimum)	
Exclusive Owner Connection - 4 x 3Phase End Devices (minimum)	

- The data size is configured in number of devices with corresponds to the number of RG..N solid state relays connected to the NRGCE-IP. In the below example 32 Devices (RG..Ns) are selected for each of the two connections (Exclusive Owner and Input Only).

Name	Size	Tag Suffix
Exclusive Owner Connection	Input: 32 x Devices Output: 32 x Devices	1 NRGCEIP_01.11 NRGCEIP_01.01
Input Only Connection	Input: 32 x Devices Output: 0 byte(s)	2 NRGCEIP_01.12 <none>

- Select the 'Disable Keying' from the **Electronic Keying** drop down and then click 'OK'.

Name	Size	Tag Suffix
Exclusive Owner Connection	Input: 32 x Devices Output: 32 x Devices	1 NRGCEIP_01.11 NRGCEIP_01.01
Input Only Connection	Input: 32 x Devices Output: 0 byte(s)	2 NRGCEIP_01.12 <none>

- Click 'Yes' when the following message window pops-up.

Logix Designer

! These changes will cause module data types and properties to change.
Data will be set to default values unless it can be recovered from the existing module properties.
Verify module properties before Applying changes.

Change module definition?

Yes No

- Click on the **Connection** tab and set the Request Packet Interval for each connection. Note that they acceptable range of the RPI is between 8ms and 1000ms.

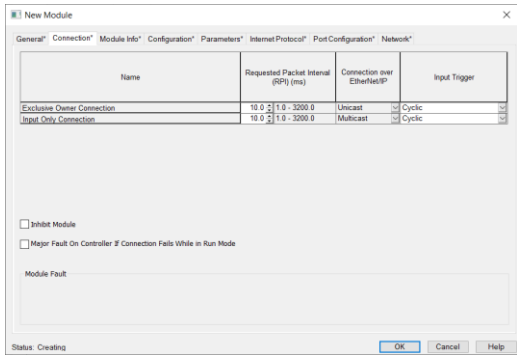

- Finally configure the device type and the corresponding start-up parameters for each end-device from the Configuration tab. For more information on the start-up parameters see section 4.3.

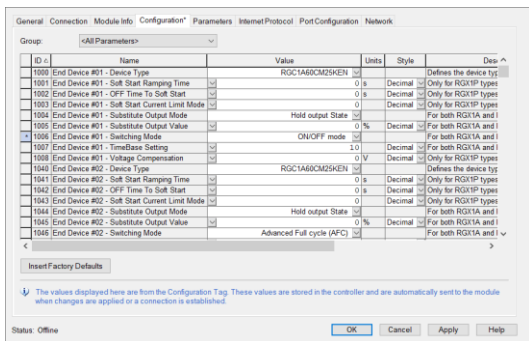

4.3 Start-up Parameters

The list of start-up parameters includes the parameters for all possible 32 devices that can be connected to 1 NRGC-EIP controller. You can identify the address of the End device by the End Device XX where xx indicates the position of the device on the bus chain. All start-up parameters are associated with the exclusive owner connection.

If there are less than 32 devices e.g. 18 devices on the bus chain, the remaining settings for End device 19 up to End device 32 can be ignored.

	Parameter	Description	Values
End Device XX	Device type	Set the part number of the device connected on the bus chain. Select 'Empty' if no device is connected on that slot.	Empty/ RGC1A60CM25KEN/ RGC1A60CM32KEN/ RGC1A60CM32GEN/ RGC1A60CM42GEN/ RGC1A60CM62GEN/ RGS1A60CM50KEN/ RGS1A60CM92KEN/ RGS1A60CM92GEN/ RGC1P60CM25KEN/ RGC1P60CM32KEN/ RGC1P60CM32GEN/ RGC1P60CM42GEN/ RGC1P60CM62GEN/ RGS1P60CM50KEN/ RGS1P60CM92KEN/ RGS1P60CM92GEN
	Voltage compensation <i>(only available for RGx1P..N)</i>	Set the reference voltage used to compensate for deviations in voltage when Voltage Compensation is activated 0 -> Voltage compensation is disabled 42 – 600 V – reference voltage for voltage compensation	0, 42 – 600V Default (0)
	Switching mode	Set the switching mode that the RG..N shall use at the output	0 → External (only for RGx1A..N) 1 → ON/OFF 2 → Burst 3 → Advanced full cycle 4 → Distributed full cycle 5 → Phase Angle (only for RGx1P..N) RGx1A..N default (ON/OFF) RGx1P..N default (Phase Angle)
	Timebase	Set the desired timebase (only applicable for Burst firing mode) This parameter is in steps of 0.1, therefore a value of 11 = 1.1s	0.1 - 10s 0.1s (default)
	Substitute output mode	Set the output mode to be used in case of a communication timeout	Clear output / Hold output (default) / Set Value
	Substitute output value	Set the % control level to be used in case of a communication timeout. (Only applicable for 'Set Value option' for Output substitute mode)	0– 100% Default (0%)

	<p>Soft start ramping time (only available for RGx1P..N)</p>	<p>Activate soft start with time whereby ramping will vary linearly with the set time</p> <p>0 -> soft start with time is disabled</p> <p>0.1 – 25.5s -> soft start with time is abled with the set time</p> <p>This parameter is in steps of 0.1, therefore a value of 11 = 1.1s</p> <p>Note: soft start with time and soft start with current limit are mutually exclusive</p>	<p>0 – 255 (0 – 25.5s) Default (0s)</p>
	<p>Soft start current limit mode (only available for RGx1P..N)</p>	<p>Set the current limit to be utilised with Soft start with current limit mode</p> <p>0 -> soft start with current limit is disabled</p> <p>0.1 – RG..N model dependent -> soft start with current limit is enabled with the set current limit. (Recommended 1.2 – 1.5 times the nominal current)</p> <p>This parameter is in steps of 0.01, therefore a value of 6600 = 66A</p> <p>Note: soft start with time and soft start with current limit are mutually exclusive</p>	<p>0 – RG..N model dependent Default (0)</p>
	<p>OFF time to soft start (only available for RGx1P..N)</p>	<p>Set the non-firing time before soft start is reactivated</p> <p>0 -> soft start with occur on power up only</p> <p>0.1 – 25.5s -> non firing time for soft start to be reactivated</p> <p>This parameter is in steps of 0.1, therefore a value of 11 = 1.1s</p>	<p>0 – 255 (0 – 25.5s) Default 50 (5s)</p>

The list of start-up parameters can be sorted out by end device number from the **Group** drop down menu as shown below.

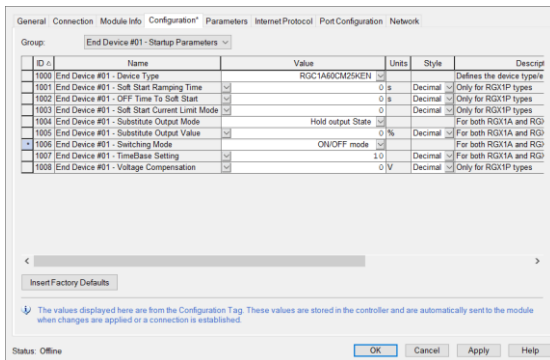

4.4 EtherNet/IP reset

The NRG-EIP shall accept two types of reset types:

Power Cycle (Reset Type 0) – This will emulate as closely as possible to a power cycle of the device. This is the default value if this parameter is omitted.

Return to Factory Defaults (Reset Type 1) – This reset mode will return as closely as possible to the factory default configuration, and then emulate power cycle as closely as possible of the device.

Apart from the standard reset functionality as specified in EtherNet/IP, Reset Type 1 shall set the auto-addressing flag in the NRG-EIP. Therefore, an auto-addressing command will occur on next NRG-EIP powerup. For more information regarding Auto-addressing function refer to Section 3.3

Note Any of the above factory resets shall NOT perform a factory reset on the NRG solid state relays (RG..Ns). A factory reset on the RG..Ns can be done via an explicit command. Refer to the Communications section for more information.

4.5 Setting a fixed IP address

The NRG-EIP supports both DHCP and BOOTP protocols for the device to get an IP address. By default, the NRG-EIP tries to get an address from a DHCP server. Both the DHCP and BOOTP protocols can be enabled / disabled via attribute 3 (Configuration Control) of the TCP/IP server.

The NRG-EIP can be set to a fixed IP by following these steps:

- 1) Set attribute 3 of the TCP/IP Interface Object to 0 (Stored Value)
- 2) Set the preferred IP address, subnet mask etc in attribute 5 of the TCP/IP Interface Object

Note: The fixed IP is stored permanently in the NRG-EIP and thus it is not lost upon restart of the device.

5. Communication

5.1 Exclusive Owner Connection – Implicit Messaging

The implicit data associated with the Exclusive owner connection includes parameters measured by each NRG solid state relay as well as the control value from the PLC to control each solid state relay. Start-up parameters are delivered on connection established for each end device. Refer to the below tables for the list of information provided via implicit messaging.

Connection path: 20 04 24 66 2C 64 2C 65

Request Packet Rate (RPI) range: 8ms – 512ms

Time out Multiplier Range: 4 - 512

Input Data

Data	Data type
Hold Current Reading	uint16
Voltage RMS Reading	uint16
Frequency Reading	uint16
Current RMS Reading	uint16
Apparent Power Reading	uint16
Real Power Reading	uint16

The current measurement is returned as scaled integers. Therefore, a current value of 16.81A will be received as 1681. The PLC program has to convert the numbers into floating point values. For further information regarding the scaling of each measurement, refer to the Measurements section in this User Manual.

Note: 'Ref' terminal connection is required for Voltage, Apparent Power and Real Power readings. Otherwise, the readings of these parameters will be 0.

Output Data

Data	Data type
Control level (0 -100%)	uint8

In case of **ON/OFF** control mode, a control level < **100%** shall indicate SSR output **OFF** and a control level of **100%** shall indicate SSR output **ON**.

For the **Power control** firing modes (Burst, Distributed full cycle and Advanced full cycle) the % **control value** shall be translate to % **power** of the SSR output. Refer to Section 6.2 for more information on Switching Modes.

5.2 Input Only Connection – Implicit Messaging

Implicit data from the Input only connection includes the alarming data from each end device connected on the bus chain as well as the NRG controller. Additionally, configuration and communication status data for each end device is also transferred. With this connection there are no configuration parameters.

Connection path: 20 04 23 6B 2C 69 2C 6A

Request Packet Rate (RPI) range: 8ms – 512ms

Time out Multiplier Range: 4 - 512

Fixed data irrespective of active devices:

Name	Data type	Description
Unused Data	2 bytes, WORD, big-endian encoding	<i>reserved for future use</i>
NRG Controller Status	2 bytes, WORD, big-endian encoding	Bit 0 – NRG Controller reset Flag Bit 1 – <i>Not used</i>

		Bit 2 – Internal error alarm Flag Bit 3 – <i>Not used</i> Bit 4 – Bus error Flag Bit 5 – Device limit error Flag Bit 6 – Device conflict error Flag Bit 7 – Termination error Flag Bits 8 – Device position error Flag Bit 9 – Supply out of range error Flag Bit 10 – Device Unconfigured error Flag Bit 11 – Device Incompatible error Flag Bits 12:15 – <i>Not used (shall be 0)</i>
End Device XX – Configuration and Communication Status	1byte, BYTE, XX is from 1 to 32	Bit 0 – Substitute submodule (Module type does not match Device Type in start-up parameters, but configuration is set) Bit 1 – Wrong submodule (Module type does not match Device Type in start-up parameters and configuration is not set) Bit 2 – Module is not configured with start-up parameters. Bit 3 – Device not reachable Bit 4 – Device position error Bit 5 – Empty slot Bit 6 – Device incompatible error, Bit 7 – <i>Not used.</i>

Input Data per each non-empty slot:

Name	Data type	Description
Alarm Status	2 bytes, WORD, big-endian encoding	Bit 0 – Mains loss alarm Flag Bit 1 – Load loss/SSR open circuit alarm Flag Bit 2 – RG..N short circuit alarm Flag Bit 3 – Voltage out of range alarm Flag Bit 4 – Current out of range alarm Flag Bit 5 – Frequency out of range alarm Flag Bit 6 – Over-temperature pre warning alarm Flag Bit 7 – Temperature out of range alarm Flag Bit 8 – Load deviation alarm Flag Bit 9 – Soft start current limit reached Flag Bit 10 – Voltage Compensation not possible Flag Bits 11-15 - <i>Not used (shall be 0)</i>
End device General Status	2 bytes, WORD, big-endian encoding	Bit 0 – Device reset Flag Bit 1 – <i>Autoconfiguration Flag (for internal use)</i> Bit 2 – Internal Error Alarm Flag Bit 3 – Communication Error Flag Bits 4:7 – Not used Bit 8: Alarm Status Flag Bit 9: TEACH busy Flag Bit 10: TEACH successful Flag Bit 11: Ramping Flag Bit 12: Voltage compensation active Flag Bits 13:15 – <i>Not used. (shall be 0)</i>

Note: For more info regarding the alarms indicated refer to Sections 7.3 & 7.4.

5.3 Explicit Messaging

Explicit data In EtherNet/IP is used to transfer data that does not require continuous updates or is not critical to the ongoing process. Any NRG parameter can be set via an explicit command even if this is included in the start-up parameters.

5.3.1 Standard CIP object classes

Standard CIP object classes can be accessed explicitly as per EtherNet/IP standards.

Identity Object

Object Class No.	Object Instance	Description
0x01	1	Identification and general information of the EIP device is provided by this object (including resetting of the device).

Class attributes

Attribute	Name	Access	Data Type	Default Value	Description
1	Revision	Get	UINT	1	Revision of this object
2	Max. instance	Get	UINT	1	Maximum instance number of an object currently created in this class level of the device
6	Maximum ID Number Class Attributes	Get	UINT	7	The attribute ID number of the last class attribute of the class definition implemented in the device
7	Maximum ID Number Instance Attributes	Get	UINT	19	The attribute ID number of the last instance attribute of the class definition implemented in the device

Instance attributes

Attribute	Name	Access	Data Type	Default Value	Description
1	Vendor ID	Get	UINT	1635	Vendor Identification
2	Device Type	Get	UNIT	12	Indication of general type of product
3	Product Code	Get	UNIT	1	Identification of a particular product code
4	Revision	Get	STRUCT of: USINT	Maj. Rev=1, Min. Rev =1	Revision of the product
5	Status	Get	WORD		Summary status of device
6	Serial Number	Get	UDINT	SIN Code e.g. (022106154)	Serial number of device
7	Product Name	Get	SHORT_STRING	NRGC-EIP	Human readable device identification
8	State	Get	USINT		Present state of the device
9	Conf. Consist. Value	Get	UNIT	0	Configuration Consistency Value
19	Protection Mode	Get	WORD	0	Current protection mode of the device

Common services

Service code	Service Name	Class Level	Instance Level	Description
0x01	Get Attribute All	<input checked="" type="checkbox"/>	<input checked="" type="checkbox"/>	Retrieve all attribute values
0x05	Reset	<input checked="" type="checkbox"/>	<input checked="" type="checkbox"/>	Reset the device
0x4B	Flash LEDs		<input checked="" type="checkbox"/>	Flash the device's LED for identification

0x0E	Get Attribute Single	<input checked="" type="checkbox"/>	<input checked="" type="checkbox"/>	Retrieve attribute value
0x10	Set Attribute Single	<input checked="" type="checkbox"/>	<input checked="" type="checkbox"/>	Modify attribute value

Message Router Object

Object Class No.	Object Instance	Description
0x02	1	Dispatching service requests toward the addressed object class or object class instance. The EtherNet/IP protocol stack implements the Message Router object exclusively at class level

Class attributes

Attribute	Name	Access	Data Type	Default Value	Description
1	Revision	Get	UINT	1	Revision of this object
2	Max. instance	Get	UINT	1	Maximum instance number of an object currently created in this class level of the device
3	Number of instances	Get	UINT	1	The number of instances currently created in this class
6	Maximum ID Number Class Attributes	Get	UINT	7	The attribute ID number of the last class attribute of the class definition implemented in the device
7	Maximum ID Number Instance Attributes	Get	UINT	0	The attribute ID number of the last instance attribute of the class definition implemented in the device

Common services

Service code	Service Name	Class Level	Instance Level	Description
0x0E	Get Attribute Single	<input checked="" type="checkbox"/>	<input checked="" type="checkbox"/>	Retrieve attribute value
0x10	Set Attribute Single		<input checked="" type="checkbox"/>	Modify attribute value

Assembly Object

Object Class No.	Object Instance	Description
0x04	1	Stores process data for exchange with other EtherNet/IP devices over the network and with the host application

Class attributes

Attribute	Name	Access	Data Type	Default Value	Description
1	Revision	Get	UINT	2	Revision of this object
2	Max. instance	Get	UINT	107	Maximum instance number of an object currently created in this class level of the device
3	Number of instances	Get	UINT	5	The number of instances currently created in this class
6	Maximum ID Number Class Attributes	Get	UINT	7	The attribute ID number of the last class attribute of the class definition implemented in the device
7	Maximum ID Number Instance Attributes	Get	UINT	4	The attribute ID number of the last instance attribute of the class definition implemented in the device

Instance attributes

Attribute	Name	Access	Data Type	Default Value	Description
1	Number of Member	Get	UINT	n.a	Number of members in List

2	Member	Get	ARRAY of STRUCT	n.a	Member list
3	Data	Get/Set	ARRAY of Octet	n.a	Current process data snapshot
4	Size	Get	UINT	n.a	Process data size in number of bytes

Common services

Service code	Service Name	Class Level	Instance Level	Description
0x0E	Get Attribute Single	<input checked="" type="checkbox"/>	<input checked="" type="checkbox"/>	Retrieve attribute value
0x10	Set Attribute Single		<input checked="" type="checkbox"/>	Modify attribute value
0x18	Get Member		<input checked="" type="checkbox"/>	Get a member of instance attribute 2

Connection Manager Object

Object Class No.	Object Instance	Description
0x06	1	Manages class 1 implicit I/O and class 3 explicit connections.

Class attributes

Attribute	Name	Access	Data Types	Default Value	Description
1	Revision	Get	UINT	1	Revision of this object
2	Max. instance	Get	UINT	1	Maximum instance number of an object currently created in this class level of the device
3	Number of instances	Get	UINT	1	The number of instances currently created in this class
6	Maximum ID Number Class Attributes	Get	UINT	7	The attribute ID number of the last class attribute of the class definition implemented in the device
7	Maximum ID Number Instance Attributes	Get	UINT	0	The attribute ID number of the last instance attribute of the class definition implemented in the device

Instance attributes

Attribute	Name	Access	Data Type	Default Value	Description
1	Open Requests	Set	UINT		Number of Forward Open service requests received

Common services

Service code	Service Name	Class Level	Instance Level	Description
0x0E	Get Attribute Single	<input checked="" type="checkbox"/>	<input checked="" type="checkbox"/>	Retrieve attribute value
0x54	Forward Open	<input checked="" type="checkbox"/>		Open a new connection
0x4E	Forward Close	<input checked="" type="checkbox"/>		Close connection

Device Level Ring Object

Object Class No.	Object Instance	Description
0x47	1	Provides the configuration of the DLR protocol. DLR is used for Ethernet Ring topology.

Class attributes

Attribute	Name	Access	Data Type	Default Value	Description
1	Revision	Get	UINT	3	Revision of this object
2	Max. instance	Get	UINT	1	Maximum instance number of an object currently created in this class

					level of the device
6	Maximum ID Number Class Attributes	Get	UINT	7	The attribute ID number of the last class attribute of the class definition implemented in the device
7	Maximum ID Number Instance Attributes	Get	UINT	12	The attribute ID number of the last instance attribute of the class definition implemented in the device

Instance attributes

Attribute	Name	Access	Data Type	Default Value	Description
1	Network topology	Get	USINT	0	Current network topology
2	Network status	Get	USINT	0	Current network status
10	Active Supervisor	Get	ARRAY of 6 USINT	0	Active supervisor address
12	Capability Flags	Get	DWORD	0x82	DLR capability of the device

Common services

Service code	Service Name	Class Level	Instance Level	Description
0x01	Get Attribute All		<input checked="" type="checkbox"/>	Retrieve all attribute values
0x0E	Get Attribute Single	<input checked="" type="checkbox"/>	<input checked="" type="checkbox"/>	Retrieve attribute value

Quality of Service Object

Object Class No.	Object Instance	Description
0x048	1	Frame prioritization is mainly handled by this object instance

Class attributes

Attribute	Name	Access	Data Type	Default Value	Description
1	Revision	Get	UNIT	1	Revision of this object
2	Max. instance	Get	UNIT	1	Maximum instance number of an object currently created in this class level of the device
6	Maximum ID Number Class Attributes	Get	UNIT	7	The attribute ID number of the last class attribute of the class definition implemented in the device
7	Maximum ID Number Instance Attributes	Get	UNIT	8	The attribute ID number of the last instance attribute of the class definition implemented in the device

Instance attributes

Attribute	Name	Access	Data Types	Default Value	Description
2	DSCP PTP Event	Get/Set	USINT	59	DSCP value for PTP Event frames
3	DSCP PTP General	Get/Set	USINT	47	DSCP value for PTP general frames
4	DSCP Urgent	Get/Set	USINT	55	DSCP value for implicit messages with urgent priority
5	DSCP Scheduled	Get/Set	USINT	47	DSCP value with implicit messages with scheduled priority
6	DSCP High	Get/Set	USINT	43	DSCP value for implicit messages with high priority
7	DSCP Low	Get/Set	USINT	31	DSCP value for implicit messages with low priority
8	DSCP Explicit	Get/Set	USINT	27	DSCP value for explicit messages

Common services

Service code	Service Name	Class Level	Instance Level	Description
0x0E	Get Attribute Single	<input checked="" type="checkbox"/>	<input checked="" type="checkbox"/>	Retrieve attribute value
0x10	Set Attribute Single	<input checked="" type="checkbox"/>	<input checked="" type="checkbox"/>	Modify attribute value

TCP/IP Interface Object

Object Class No.	Object Instance	Description
0x0F5	1	Provides an interface to control a device's TCP/IPv4 network configuration, most importantly the device's IP Address, Network Mask, and Gateway Address

Class attributes

Attribute	Name	Access	Data Types	Default Value	Description
1	Revision	Get/Set	UINT	4	Revision of this object
2	Max. instance	Get/Set	UINT	1	Maximum instance number of an object currently created in this class level of the device

Instance attributes

Attribute	Name	Access	Data Types	Default Value	Description
1	Status	Get	DWORD		Interface status
2	Configuration Capability	Get	DWORD	0x95	Interface capability flags
3	Configuration Control	Get/Set	DWORD	1 (BOOTP)	Interface control flags
4	Physical Link Object	Get	STRUCT of UINT	0x20 0xF6 0x24 0x01	Path to physical link object
5	Interface Configuration	Get/Set	STRUCT of UDINT	0	Interface configuration (IP address, subnet mask, gateway address etc)
6	Host Name	Get/Set	STRING	""	The Host Name attribute contains the device's host name, which can be used for informational purposes
8	TTL Value	Get/Set	USINT	1	TTL value for EtherNet/IP multicast packets
9	Mcast Config	Get/Set	STRUCT of USINT	0	IP multicast address configuration
10	SelectACD	Get/Set	BOOL	1 (Enabled ACD)	Activates the use of ACD
11	LastConflictDetected	Get/Set	STRUCT of USINT	0	Structure containing information related to the last conflict detected
13	Encapsulation Inactivity	Get/Set	UINT	120	Number of seconds till TCP connection is closed on encapsulation inactivity

Common services

Service code	Service Name	Class Level	Instance Level	Description
0x01	Get Attribute All		<input checked="" type="checkbox"/>	Retrieve all attribute values
0x0E	Get Attribute Single	<input checked="" type="checkbox"/>	<input checked="" type="checkbox"/>	Retrieve attribute value
0x10	Set Attribute Single		<input checked="" type="checkbox"/>	Modify attribute value

Ethernet Link Object

Object Class No.	Object Instance	Description
0xF6	1 & 2	This CIP object is responsible for the configuration and status information of each available Ethernet port

Class attributes

Attribute	Name	Access	Data Types	Default Value	Description
1	Revision	Get	UINT	4	Revision of this object
2	Max. instance	Get	UINT	2	Maximum instance number of an object currently created in this class level of the device
3	Number of instances	Get	UINT	2	The number of instances currently created in this class

Instance Attributes

Attribute	Name	Access	Data Types	Default Value	Description
1	Interface Speed	Get	UDINT	100	Interface speed currently in use
2	Interface Flags	Get	DWORD	0x20	Interface status flags
3	Physical Address	Get	ARRAY of 6 USINT's	MAC add. of NRGCE-IP	MAC layer address
4	Interface Counters	Get	STRUCT of UDINT		Interface specific counters
5	Media Counters	Get	STRUCT of UDINT		Media specific counters
6	Interface Control	Get/Set	STRUCT of WORD	0	Configuration for physical interface
7	Interface Type	Get	USINT	0x02	Type of interface: twisted pair, fibre
8	Interface State	Get	USINT	0	Current state of interface
9	Admin State	Get/Set	USINT	2 (disabled)	Administrative state: 1- enabled 2- disabled
10	Interface Label	Get	SHORT_STRING	Port 0 or Port 1	Human readable identification
11	Interface Capability	Get	STRUCT of USINT	10 / HD, 10 / FD 100 / HD 100 / FD	Indication of capabilities of the interface
768	MDIX	Get/Set	USINT	1	MDIX configuration: 1- Autodetect 2- Explicit MDI 3- Explicit MDIX

Common Services

Service code	Service Name	Class Level	Instance Level	Description
0x01	Get Attribute All		<input checked="" type="checkbox"/>	Retrieve all attribute values
0x0E	Get Attribute Single	<input checked="" type="checkbox"/>	<input checked="" type="checkbox"/>	Retrieve attribute value
0x10	Set Attribute Single		<input checked="" type="checkbox"/>	Modify attribute value
0x4C	Get and Clear		<input checked="" type="checkbox"/>	Retrieves and clears attributes 4 & 5

5.3.2 Vendor specific object classes

In order to access the **indexing data**, the following is required:

Class Object	0x64
Instance	Address of NRG-C-EIP (Always 255) OR Address of RG..N (1 -32) depending on its position on the NRG bus chain
Attribute	The index of the parameter (see tables below)
Attribute Size	The size of the attribute selected

The datatype of each attribute is uint16. The attributes are in a little endian format.

Indexing data for NRG-C-EIP

Attribute	Description	Services	Size	Valid Values
1	Auto-addressing Command/Status	Get Attribute Single (0x0E) Set Attribute Single (0x10)	2 bytes	Writing: 1 -> Trigger an auto-addressing of the NRG bus chain on the next NRG-C-EIP powerup.

Indexing data for RG..Ns

Attribute	Description	Services	Size	Parameters
1	Monitoring Parameters	Get Attribute Single (0x0E) Set Attribute Single (0x10)	2 bytes	Hold current period
2	Alarm Parameters	Get Attribute Single (0x0E) Set Attribute Single (0x10)	16 bytes	Alarm Setting Over voltage limit Under voltage limit Over current limit Under current limit Over frequency limit Under frequency limit Over temperature pre-warning
3	Control Parameters	Get Attribute Single (0x0E) Set Attribute Single (0x10)	8 bytes	Output substitute mode Output substitute value Switching mode Time base (for Burst firing mode)
4	RG..N Commands	Get Attribute Single (0x0E) Set Attribute Single (0x10)	2 bytes	RG..N command
5	TEACH Parameters	Get Attribute Single (0x0E) Set Attribute Single (0x10)	6 bytes	TEACH voltage reference TEACH current reference TEACH % load deviation
6	Load Running Hours	Get Attribute Single (0x0E) Set Attribute Single (0x10)	2 bytes	Load Running hours
7	SSR History	Get Attribute Single (0x0E)	6 bytes	Energy Reading (low) Energy Reading (high) SSR ON time

A description of each parameter with an indication of the possible values is listed in the table below

Parameters	Description	Values
Hold current period	Set the no. of cycles over which the Hold Current Reading is calculated	1 – 32 18 (default)
Alarm Setting	Set the alarm recovery mode	0 → Automatic (default) 1 → Manual
Over voltage limit (OVL)	Set the over and under voltage limit if desired which will trigger an alarm if the voltage reading is beyond the range	0 – 660V & > UVL value Default (660V)
Under voltage limit (UVL)		0 – 660V & < OVL value Default (0V)
Over current limit (OCL)	Set the over and under current limit if desired which will trigger an alarm if the current reading is beyond the range	0 – RG..N model dependent & > UCL value Default (RG..N model dependent)
Under current limit (UCL)	This parameter is in steps of 0.01, therefore a value of 1745 = 17.45A Check 'Measurements' section for more information	0 – RG..N model dependent & < OCL value Default (0A)
Over frequency limit (OFL)	Set the over and under frequency limit if desired which will trigger an alarm if the current reading is beyond the range	44 – 66Hz & > UFL value Default (66Hz)
Under frequency limit (UFL)		44 – 66Hz & < OFL value Default (44Hz)
Over temperature pre-warning	Δ temperature from max at which the RG..N will issue an alarm	0 – 50 degC Default (0 degC)
Output substitute mode	Set the output mode to be used in case of a communication timeout	0 → Clear Output 1 → Hold Output (default) 2 → Set Value
Output substitute value	Set the % control level to be used in case of a communication timeout. (Only applicable for 'Set Value option' for Output substitute mode)	0 (default) – 100%
Switching mode	Set the switching mode that the RG..N shall use at the output	0 → External (only for RGx1A..N) 1 → ON/OFF 2 → Burst 3 → Advanced full cycle 4 → Distributed full cycle 5 → Phase Angle (only for RGx1P..N) RGx1A..N default (ON/OFF) RGx1P..N default (Phase Angle)
Timebase	Set the desired timebase. (only applicable for burst firing mode) This parameter is in steps of 0.1, therefore a value of 11 = 1.1s	0.1 (default) - 10s
RG..N commands	Insert value to indicate the command that shall be executed by the RG..N	1 -> start a TEACH operation 4 -> store parameters permanently in RG..N 8 -> clear Latched Alarms in case latching of alarms is activated 99 -> factory reset of RG..N

TEACH voltage reference	Holds the reference voltage to be used for the load deviation alarm. Value can be updated automatically with a TEACH command or manually. If TEACH is not successful value will reset to 0	0 (default) – 660VAC
TEACH current reference	Holds the reference current to be used for the load deviation alarm. Can be updated automatically with a TEACH command or manually If TEACH is not successful value will reset to 0 This parameter is in steps of 0.01, therefore a value of 1745 = 17.45A	0 – Max. current limit (RG..N model dependent)
TEACH % load deviation	Holds the percentage load deviation used for the load deviation alarm.	4 – 100% 10% (default)
Load running hours reset	Use this index to reset the load running hours reading in case of load or SSR replacement in hours	0 hrs (default) -
Energy Reading (low) <i>(read only)</i>	The energy reading is split into 2 indexes. This index holds the lower value	0 (default) -
Energy Reading (high) <i>(read only)</i>	This index holds the upper value of the energy reading	0 (default) -
SSR ON time <i>(read only)</i>	Holds the accumulated time in hours that the output of the RG..N was switched ON	0 (default) -

In order to access the **Module and Network status**, the following is required:

Class Object	0x68
Instance	1
Attribute	2 => Module Status (UDINT, 4-bytes, little-endian encoding) 3 => Network Status (UDINT, 4-bytes, little-endian encoding)
Services	Get Attribute Single (0x0E) and Get Attribute All (0x01)

Below are the possible values for each attribute:

Module Status

Returned Value	Description
0	No power. The module status LED is off.
1	Self-test. During POST the module status LED should be flashing green and red
2	Standby i.e. device not yet configured. In this case the module status LED is flashing green.
3	Device operational. The module status LED is steady green
4	Major recoverable fault. In this case the module status LED flashes red.
5	Major unrecoverable fault. In this specific scenario the module status LED is steady red.

Network Status

Returned Value	Description
0	Not powered, no IP address. The network status LED is off
1	No connection. An IP address has been configured, but no CIP connections are established, and an Exclusive Owner connection has not timed out. The network status indicator is flashing green
2	Connected. At least one CIP connection of any transport class is established, and an Exclusive Owner connection has not timed out. The network status indicator is steady green.
3	Connection timeout. An Exclusive Owner connection for which this device is the target has timed out.
4	Duplicate IP. The device has detected that its IP address is already in use. The network status LED is static red.
5	Self-test. Mainly this occurs during POST, and the network status LED should be flashing green and red

6. Functions

6.1 Functions overview

The NRG solid state relays are equipped with a range of functionality within one device. For a list of some of the features refer to the table below.

Feature	RGx1A..CM..N	RGx1P..CM..N
External Control	X	-
ON / OFF mode	X	X
Burst Firing mode	X	X
Distributed full cycle Firing mode	X	X
Advanced full cycle Firing mode	X	X
Phase angle Firing mode	-	X
Soft start with time mode	-	X
Soft start with current limit mode	-	X
Voltage compensation	-	X
Monitoring of system parameters	X	X
SSR diagnostics	X	X
Load diagnostics	X	X
Overtemperature protection	X	X

6.2 Switching modes

ON / OFF mode

The ON-OFF mode controls the solid state relays at the user's command. Through an I/O output message, the RG..N can be controlled using the control level. A control level of 0% indicates SSR output OFF and a control level of 100% indicates SSR output ON.

The advantages of this mode are:

- It is effectively a direct replacement of the A1-A2, i.e. for existing systems, the control algorithm within the PLC can be left relatively untouched and the output is redirected via the communication interface.

All RG..Ns on the bus chain can be controlled within 10ms.

Burst Firing mode

The Burst firing mode works with the control level and a time-base parameter which can be varied from 0.1 seconds to 10 seconds. The percentage ON time is then determined by the control level via an I/O output command. Therefore, with a control level of 10% ;10% of the time-base will be ON and 90% will be OFF. The figure below shows example waveforms of this firing mode at different control levels. In this example the time base was set to 1 second. The percentage control resolution depends on the timebase set by the user. To achieve a 1% resolution, the time base has to be a minimum of 2 sec for 50Hz and 1.7 sec for 60Hz.

Output with Burst firing mode @ 33% control level



Output with Burst firing mode @ 50% control level

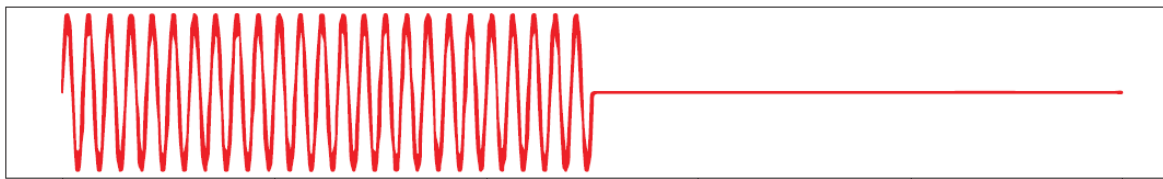

Output with Burst firing mode @ 66% control level

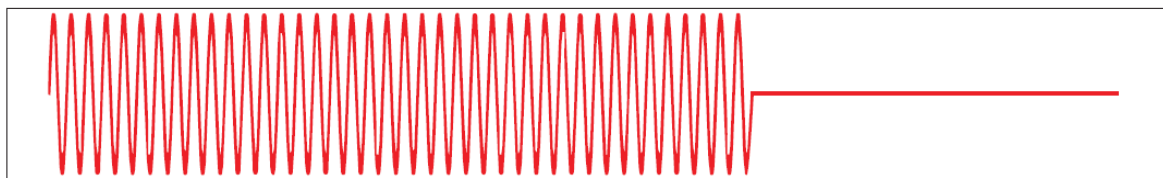

Distributed Firing mode

The Distributed firing mode works with a control level and a fixed time-base of 100 full cycles (2 seconds for 50 Hz). This mode operates with full cycles and it distributes the ON cycles as evenly as possible over the time base. In this mode, since the resolution is 1% and the time base is of 100 full cycles, the control level is equal to the number of full cycles over the whole time base.

1% = 1 full cycle every 100 cycles

2% = 2 full cycles every 100 cycles = 1 full cycle every 50 cycles

Output with Distributed firing mode @ 33% control level

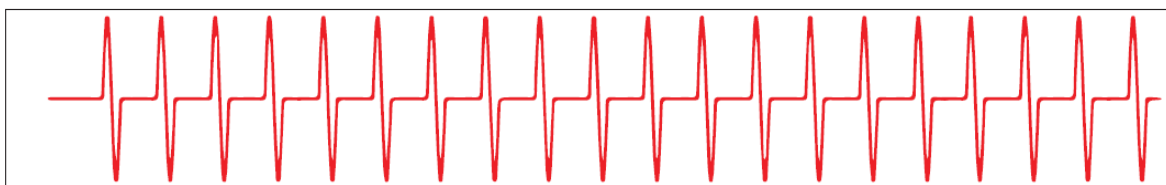

Output with Distributed firing mode @ 50% control level

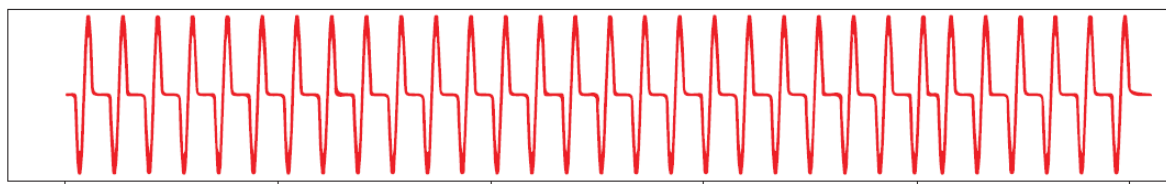

Output with Distributed firing mode @ 66% control level

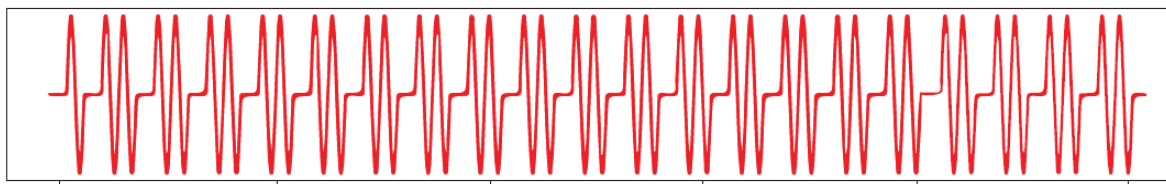

The advantage of Distributed over Burst is the reduction in thermal cycling. On the other hand, Distributed mode suffers from worse harmonics/emissions than Burst mode.

Advanced Full Cycle firing

Advanced Full Cycle (AFC) firing works on the same concept as Distributed but rather than distributing full cycles, half cycles are distributed. This mode also works over a time base of 100 full cycles (200 half cycles). In this mode, since the resolution is 1% and the time base is of 100 full cycles, the control level is equal to the number of full cycles over the whole time base. 1% = 2 half cycles every 200 half cycles = 1 half cycle every 100 half cycles 2% = 4 half cycles every 200 half cycles = 1 half cycle every 50 half cycles

Output with Advanced full cycle firing mode @ 33% control level

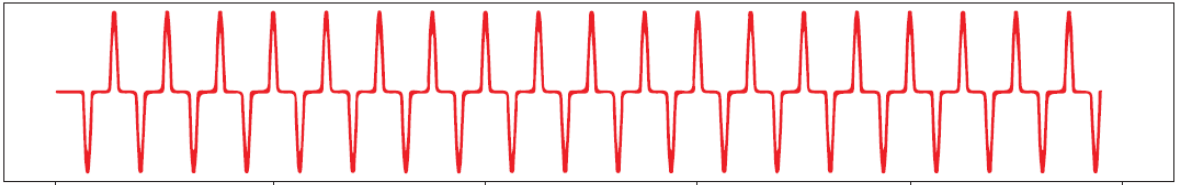

Output with Advanced full cycle firing mode @ 50% control level

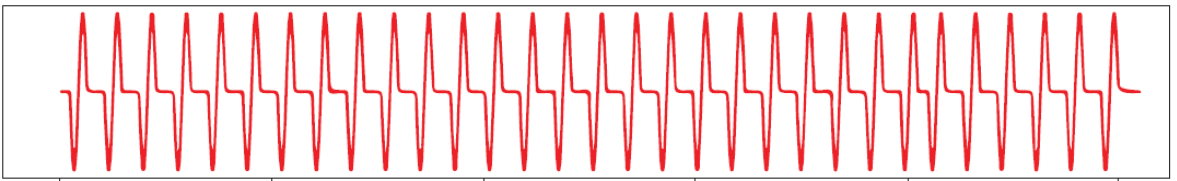

Output with Advanced full cycle firing mode @ 66% control level

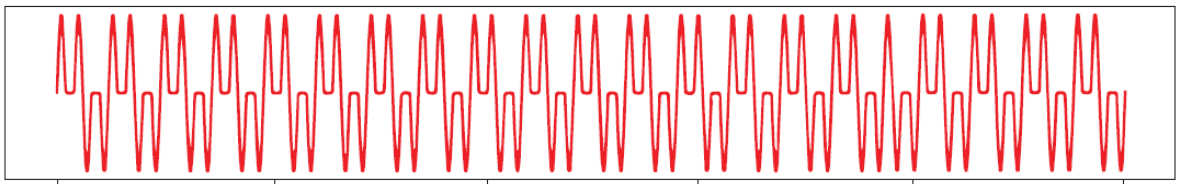

The advantage of AFC over Burst is the reduction in thermal cycling. Another advantage of AFC is that visual flicker is less noticeable than Distributed thus making it suitable for shortwave infrared heater applications. AFC has the disadvantage of worse harmonics/emissions than Burst and also slightly worse than Distributed.

External firing mode

The RG..N can also be controlled externally via the A1,A2 terminal behind the blanking cover. For further information on the technical specifications of the input terminal, please refer to the product datasheet. External firing is only available on the RGx1A..CM..N solid state relays.

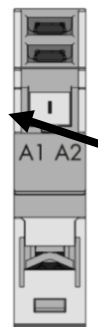

Figure 12 Remove blanking cover from bottom of RG..N to control the RG..N externally. RGM25 plug is required (not included)

Phase Angle Firing mode

The Phase angle switching mode is available only on the RGx1P.N solid state relays and works in accordance with the phase angle control principle. The power delivered to the load is controlled by the firing of the thyristors over each half mains cycle. The firing angle depends on the control level that determines the output power to be delivered to the load. The power to the load is varied linearly with the control level.

Output with Phase angle firing mode @ 33% control level



Output with Phase angle firing mode @ 50% control level

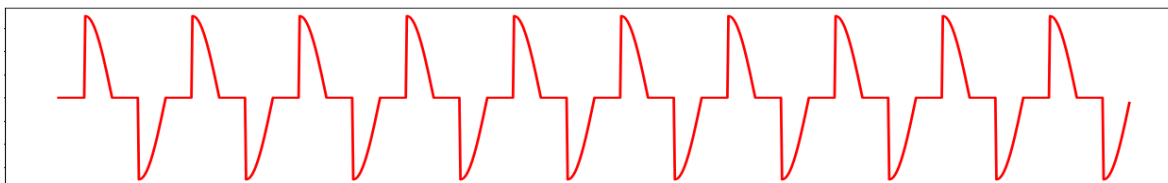

Output with Phase angle firing mode @ 66% control level

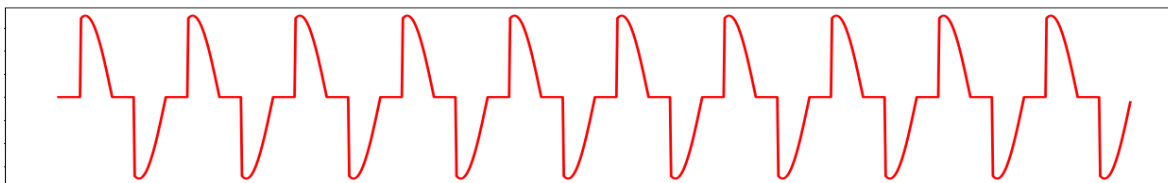

The advantage of Phase angle over the other switching modes is its precise resolution of power. However, Phase angle generates excessive harmonics vs other switching modes. With Phase angle control, the flickering of IR heaters is eliminated completely.

Soft Starting

Soft starting is only available on the RGx1P.N solid state relays. It is utilised to reduce the start-up current of loads having a high cold to hot resistance ratio such as short wave infrared heaters. The thyristor firing angle is gradually increased in order to apply the power to the load smoothly. Soft start can be applied with all the other available switching modes (ON/OFF), Burst, Distributed full cycle, Advanced full cycle and Phase angle. When applied with phase angle, the soft start will stop at the set control level whereas for the other switching mode the soft start will stop until fully ON. Soft start shall be applied upon power up and after a number of non-firing cycles settable by the user (OFF time to soft start setting).

Soft start with Phase angle



Soft start with ON/OFF, Burst, Distributed full cycle and Advanced full cycle firing modes

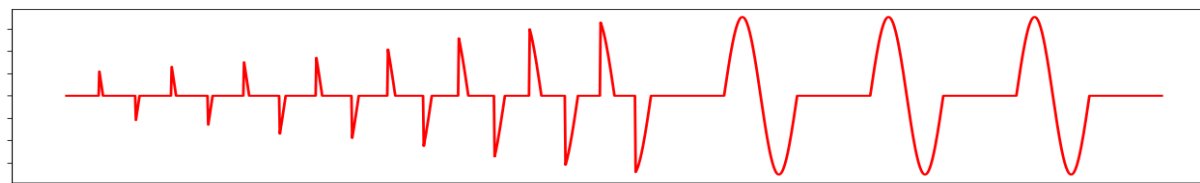

There are two type of soft start modes on the RGx1P..CM..N:

Soft start with time mode

The soft start will apply the power smoothly to the load over a time period of maximum 25.5s. This is settable via the communication system (Soft start ramping time setting).

Soft start with current limit mode

This soft start mode works with a current limit set by the user via the communication. The soft start time will adapt such that the set current limit is not exceeded, and the soft start occurs in the shortest amount for time. The recommended setting for the current limit is 1.2 - 1.5 times the nominal current. The maximum settable current limit is 2 times the rated current of the RG..CM..N variant used. If the current limit is set too low and the current limit is reached, a warning will be notified (Soft start current limit reached).

Voltage compensation

When voltage compensation is utilised, the output power on the output of the solid state relay will remain balanced despite any voltage deviations from normal readings. The algorithm uses a reference voltage set by the user via the communication (Voltage compensation setting) to compute the compensation factor. A new control level is calculated by applying the compensation factor on the control level from the main controller.

The compensation factor (C.F.) applied on the control level is calculated as follows:

$$C.F. = \left(\frac{\text{Reference Voltage}}{\text{Measured Voltage}} \right)^2$$

If the calculated control level after the compensation factor is applied is beyond the control level limits (0 & 100%), the absolute limit will be applied (0 or 100%) and a warning message will be triggered (Voltage compensation not possible).

Note: For percentage power control switching modes (Burst, Distributed Full cycle, Advance Full cycle and Phase Angle), the response time for each RG..N on the bus chain shall increment by a half mains cycle with each device. Therefore, with 32 devices on the bus chain (max); all RG..Ns are controller within 250 and 320ms depending on the cycle time.

6.3 Measurements

Voltage RMS

The last reading of the rms voltage is recorded. The value of the reading is in 1V steps hence a value of 50 means 50V, a value of 700 means 700V. If a fault occurs in the system such that it is not possible to measure the voltage, the reading is 0. The reading is updated every half cycle based on the average of the last 16 half cycles. If the Ref terminal is not connected this register reads the on-state voltage of the RG..N when the output is ON.

Current RMS

The last reading of the RMS current is recorded. This reading is in steps of 0.01A hence a value of 50 means 0.5A and a value of 1747 means 17.47A. If a fault occurs in the system such that it is not possible to measure the current, this value is 0. This reading is updated every half cycle but is based on the average of the last 16 half cycles.

Frequency RMS

The last reading of the frequency is recorded. The value is in steps of 1 Hz. If a fault occurs in the system such that it is not possible to measure the frequency, this register gives a value of 0. This value is updated every half cycle but is based on the averaged value of the last 15 cycles.

Hold Current

The average current of the last 16 ON half cycles. This value is in steps of 0.01A hence a value of 50 means 0.5A and a value of 1747 means 17.47A. This measurement can be used as feedback current for an I² control feedback loop.

Apparent Power

The apparent power reading is recorded in VA. This reading is in steps of 1VA and hence a value of 567 would mean 567VA. This value is updated every half cycle and is a multiplication of the Voltage RMS value and Current RMS value determined in the last half cycle. This reading requires the 'Ref' terminal to be connected, otherwise the value will be constantly 0.

Real Power

The real power reading is recorded in W. This reading is in steps of 1W and hence a value of 567 would mean 567W. This value is updated every half cycle and is a multiplication of the Voltage RMS value and Current RMS value determined in the last half cycle. This reading requires the 'Ref' terminal to be connected, otherwise the value will be constantly 0. Note that for resistive loads with power factor = 1, the real power and the apparent power will be the same.

Energy

The initial value of this register at power-up is the last reading recording before switch OFF of the NRG controller. In case of a new device this value starts from 0. This reading starts counting from the initial value at power-up the kWh consumed during this power up. This reading is updated in steps of 1 kWh hence a value of 1034 would mean 1034kWh.

SSR Running Hours

This reading records the accumulated time in hours that the output of the RG..N was switched ON. The value is updated every half cycle. The initial reading at power-up is the last reading recorded before switch OFF of the NRG controller. In case of a new device this value starts from 0. This reading starts from the initial value at power-up the running hours during this power up. The reading is updated in steps of 1 hour hence a value of 1034 would mean 1034h that the output was ON during its lifetime. In the event that the counter reaches its maximum value, the counter shall roll back to 0 and start counting up again.

Load Running Hours









This reading records the accumulated time in hours that the output of the RG..N was switched ON. The value of this register is updated every half cycle. The initial value of this register at power-up is the last reading recording before switch OFF of the NRG control. This reading is updated in steps of 1 hour hence a value of 1034 would mean 1034h that the output was ON during its lifetime. In case of a new SSR this value starts from 0. This reading can be reset in case of a load or SSR replacement via the Load Running Hours reset setting. A 'Store Permanently' command shall be executed after modifying the value.

7. Alarms and Diagnostics



The NRG bus chain is equipped with on-board diagnostics to facilitate troubleshooting. The status of each component can be identified via the status LEDs on the façade of the product as well as via the communication system.

The errors identified by the NRG controller indicate any identified issues relating to the status of the NRG internal bus. On the other hand, the alarms on the NRG solid state relay indicate any alarms relating to the SSR or the process.

7.1 LED indications – NRG Controller

ON	Green 	ON:	US is present at terminals Us+ Us-
		OFF:	US is not present at terminals Us+ Us-
Link (X1, X2)	Green 	ON:	The NRG controller is linked to Ethernet
		OFF:	The NRG controller has no link to Ethernet
RX/TX (X1, X2)	Yellow 	Flickering:	The NRG controller is sending/receiving Ethernet frames
		OFF:	The NRG controller is not sending/receiving Ethernet frames
Bus	Yellow 	ON:	Transmission of messages from NRG Controller to RG..Ns
		OFF:	Internal bus is idle
MS	Red / Green  	Green:	NRG Controller is operational
		Green Flickering	NRG Controller has not been configured
		Green / Red Flickering:	NRG Controller is performing its power-up testing
		Red:	NRG Controller has detected a major unrecoverable fault
		Red Flickering:	NRG Controller has detected a major recoverable fault
		OFF:	NRG Controller is powered off
NS	Red / Green  	Green:	Connected: An IP address is configured and at least one CIP connection is established
		Green Flickering:	No connections: An IP address is configured but no CIP connections are established
		Green / Red Flickering:	NRG Controller is performing its power-up testing
		Red:	Duplicate IP: NRG Controller detected that its IP address is already in use
		Red Flickering:	Connection timeout: An IP address is configured and and Exclusive Owner connection has timed out
OFF:	NRG Controller does not have an IP address or is powered off.		
Alarm	Red 	2 Flashes:	Configuration error (Device limit error, Device conflict error, Device unconfigured error, Device position error)
		4 Flash	Supply error
		8 Flashes	Communication error
		9 Flashes	Internal error
		10 Flashes	Termination error

7.2 LED indications – RG..N

LOAD	Green 	ON:	SSR output is ON
		OFF:	SSR output is OFF
BUS	Yellow 	ON:	Communication ongoing between NRG controller and RG..Ns
		OFF:	Communication between NRG controller and RG..Ns is idl
Alarm	Red 	100% ON:	SSR over-temperature
		1 Flash	Load deviation
		2 Flashes	Mains loss
		3 Flashes	Load loss / SSR open circuit
		4 Flashes	SSR short circuit
		5 Flashes	Frequency out of range
6 Flashes	Current out of range		

	7 Flashes	Voltage out of range
	8 Flashes	Communication error (BUS)
	9 Flashes	Internal error

7.3 Alarms – NRG Controller

Internal Error	
Description	<p>This alarm is issued when a problem arises within the internal circuitry of the NRG controller. In the presence of this alarm, the NRG controller will try as much as possible to proceed with normal operation. It is up to the user to detect the presence of errors reported by the NRGC and take action accordingly.</p> <p>When continuing operation with NRGCs reporting an internal error there is a risk that communication may not work correctly or may not be possible, damage may occur to the RG..N devices on the BUS if the internal error is caused by an overvoltage on the supply lines.</p>
Diagnose	Consider replacing the NRG Controller.

Bus Error	
Description	This error is issued in case of wrong messages exchanged between the NRG Controller and the RG..Ns.
Diagnose	Not applicable.

Device Limit Error	
Description	More than 32 RG..Ns are detected on the NRG bus chain.
Diagnose	Confirm that the number of RG..Ns connected to one NRG Controller is < 32.

Termination Error	
Description	<p>This alarm is issued if the NRG controller detects that the BUS between the NRG controller and the RG..Ns is not correctly terminated. This can be due to:</p> <ul style="list-style-type: none"> • An internal fault in the NRG controller (start of BUS termination) • RGN-TERMRES is faulty • An internal fault in the RG..N that affects the BUS <p>This Alarm will clear (unless alarm latching is selected) when the termination of the BUS is found in order.</p>
Diagnose	Make sure RGN-TERMRES is connected to the last RG..N on the NRG bus chain.

Device Conflict Error	
Description	Two RG..Ns on the same NRG bus chain have the same address.
Diagnose	Check internal bus connections. If bus connection is correct, do an auto addressing command. Otherwise re-connect the bus as required.

Device Unconfigured Error	
Description	An RG.N on the NRG bus chain does not have an address.
Diagnose	Perform an auto-addressing command.

Device Position Error	
Description	The position of some devices on the internal bus does not correspond to the stored address.
Diagnose	Check alarms on individual RG..Ns on the internal bus for more detail.

Power supply out of range	
Description	The internal supply voltage of the NRG controller is not within the specified range.
Diagnose	Check that supply on Us+, Us- is within the specified range.

Device Incompatible Error	
Description	An RG..N connected on the bus is not compatible.
Diagnose	New devices may not be compatible with firmware of NRG Controller. Check with Carlo Gavazzi personnel.

7.4 Alarms – RG..N

SSR Overtemperature	
Description	This situation happens when the RG..N does not operate within the rated specifications causing the SSR to overheat. The output of the RG..N is switched OFF to prevent the RG..N from getting damaged due to overheating. When the RG..N cools down, the alarm automatically recovers unless alarm latching is selected, the Alarm LED is switched OFF, and the RG..N output can be switched accordingly.
Diagnose	Confirm that RG..N used is operated within the rated specifications (current rating, spacing and surrounding temperature).

SSR Overtemperature Pre-warning	
Description	This is not an alarm condition and has no effect on the function of the RG..N. The Over-Temperature Pre-warning alarm is activated when the pre-warning margin set on the RG..N is not respected. For example, the over temperature prewarning has been set to 40degC and the actual delta is 39degC. In this case, the over temperature prewarning alarm is activated. This alarm is re-set when the actual temperature reading is $\geq 40\text{degC}$. This alarm does not trigger the Alarm LED on the RG..Ns.
Diagnose	Confirm that RG..N used is operated within the rated specifications (current rating, spacing and surrounding temperature).

Load deviation alarm	
Description	<p>This alarm works in conjunction with the TEACH Voltage Reference, TEACH Current Reference and TEACH % load deviation settings. If the values of the TEACH Voltage and Current reference are > 0 either through a 'TEACH' command or updated manually; the load deviation alarm is activated.</p> <p>With a TEACH command the values of Vref and Iref registers will be updated by measuring the present current and voltage over a period of time. The TEACH command is refuted in case of alarms present on the system. If the TEACH is unsuccessful, the values of Vref and Iref will be cleared to 0. The TEACH command does not take control of the output of the SSR, it is up to the user to issue a TEACH command when the output is switched ON with a control percentage of $>5\%$. The duration of the TEACH procedure shall take up to a maximum of 35s depending on the level of control percentage. A 'Store Permanently' command is required after a TEACH command for the values of the Vref and Iref to be saved permanently in the device for next power up.</p> <p>The load deviation alarm is issued when a change in resistance $>$ the % load deviation setting is detected. The resistance is measured using the Voltage and Current reference. The load deviation alarm is useful to detect changes in the load either due to load</p>

	degradation or partial load failure when more than one load is connected to the SSR.
Diagnose	Check loads for degradation or partial load failure (in case of multiple loads with 1 RGx1A..N). Take into consideration the load thermal coefficient when setting the percentage deviation in LDEVPR to avoid this alarm from being issued unnecessarily.

Mains loss	
Description	Voltage and current signals are missing for more than 3 mains half cycles. The cause is a mains loss (Ref terminal must be connected to identify this alarm otherwise alarm can be either mains loss or load loss)
Diagnose	Ensure mains supply is ON. Confirm that protection (fuses / miniature circuit breakers) have not tripped. Ensure L1 terminal of RG..N is properly connected.

Load loss / SSR Open Circuit	
Description	Load is not switching ON for > a mains half cycle when control signal is present. The cause is either a load loss or a RG..N open circuit condition.
Diagnose	Make sure that load is not faulty or if the SSR is in an open circuit condition. If an RG..N is replaced, make sure to follow the re-addressing procedure.

SSR Short Circuit	
Description	This condition is identified when current >300mA flows through the RG..N output when control signal is OFF.
Diagnose	Make sure that the appropriate short circuit protection is utilised. If an RG..N is replaced, follow readdressing procedure at power-up. Check load and protection devices (fuses or Miniature Circuit Breakers) status before re-starting.

Frequency out of range	
Description	This condition is identified when the frequency measured by the RG..N is not within the set range hence is > Over Frequency value or < Under Frequency value. This alarm is issued if this condition is present for >10 seconds. Though indicated as an alarm condition, this alarm has no effect on the function on the RG..N and it is up to the user to decide what to do when this alarm is activated.
Diagnose	Check line frequency and ensure that the over and under frequency limits are set properly. Though the switching function of the RG...N is not affected by this alarm, care must be taken to make sure RG..N is operated within its rated specification.

Current out of range																	
Description	<p>This condition is identified when the frequency measured by the RG..N is not within the set range hence is > Over Current value or < Under Current value. This alarm is issued if this condition is present for >10 seconds. Though indicated as an alarm condition, this alarm has no effect on the function on the RG..N and it is up to the user to decide what to do when this alarm is activated.</p> <p>The over current limit is bounded by the maximum current for each NRG solid state relay variant. A list of the variants with their maximum current values is listed in the table below.</p>																
Current limits	<table border="1"> <tr><td>RG1A60CM25KEN</td><td>33</td></tr> <tr><td>RG1A60CM32KEN</td><td>33</td></tr> <tr><td>RG1A60CM32GEN</td><td>47</td></tr> <tr><td>RG1A60CM42GEN</td><td>64</td></tr> <tr><td>RG1A60CM62GEN</td><td>93</td></tr> <tr><td>RGS1A60CM50KEN</td><td>55</td></tr> <tr><td>RGS1A60CM92KEN</td><td>99</td></tr> <tr><td>RGS1A60CM92GEN</td><td>99</td></tr> </table>	RG1A60CM25KEN	33	RG1A60CM32KEN	33	RG1A60CM32GEN	47	RG1A60CM42GEN	64	RG1A60CM62GEN	93	RGS1A60CM50KEN	55	RGS1A60CM92KEN	99	RGS1A60CM92GEN	99
RG1A60CM25KEN	33																
RG1A60CM32KEN	33																
RG1A60CM32GEN	47																
RG1A60CM42GEN	64																
RG1A60CM62GEN	93																
RGS1A60CM50KEN	55																
RGS1A60CM92KEN	99																
RGS1A60CM92GEN	99																
Diagnose	The over current limit is bounded by the maximum current for each NRG solid state relay variant. A list of the variants with their maximum current values is listed in the table below.																

Voltage out of range	
Description	This condition is identified when the voltage measured by the RG..N is not within the set range hence is > Over Voltage value or < Under Voltage value. This alarm is issued if this condition is present for >10 seconds. Though indicated as an alarm condition, this alarm has no effect on the function on the RG..N and it is up to the user to decide what to do when this alarm is activated.
Diagnose	Check mains and ensure that the over and under voltage limits are set properly. Though the switching function of the RG..N is not affected by this alarm, care must be taken to make sure RG..N is operated within its rated specification.

Communication (BUS) error	
Description	This alarm indicates that a problem in the communication between the NRG-EIP and the RG..N has occurred. It is only issued via the Alarm LED on the RG..N. This alarm should also trigger the BUS error alarm via the communication system.
Diagnose	Not applicable

Internal error	
Description	This alarm is issued when a problem arises within the internal circuit of the RG..N. In the presence of this alarm, the RG..N will try as much as possible to proceed with normal operation. It is up to the user to detect the presence of errors reported by the RG..N and take action accordingly. When continuing operation with RG..Ns reporting an internal error there is a risk that the messages are not correctly received by the RG..N and/or replies will not be correctly received by the NRG and/or main controller.
Diagnose	Confirm presence of 24V supply voltage on the NRG Controller US terminals. Otherwise, replace the RG..N reporting an internal error.

Soft start current limit reached (only available for RGx1P..N)	
Description	The set current limit was reached during soft start
Diagnose	The set current limit may be too low for the nominal current. The recommended current limit value is 1.2 – 1.5 times the nominal current

Voltage compensation not possible (only available for RGx1P..N)	
Description	Mains voltage has deviated too much such that the control level after the correction factor has been applied is beyond the control limits (either < 0% or > 100%)
Diagnose	Not applicable

Device Incompatible Error	
Description	The RG..N connected is not compatible with NRG Controller
Diagnose	New devices may not be compatible with old firmware of NRG Controller. Check with Carlo Gavazzi personnel.

8. Service and Maintenance

8.1 Internal bus communication check

During the initially installation of the system, it may be useful to do a communications check before connecting the NRG controller to the PLC. A communications check will ensure that all RG..Ns connected on the bus chain are responding.

To perform a communications check, press the blue button on the facade of the NRG controller for 2 – 5 seconds. The NRG controller will ping each device sequentially. All communicating RG..Ns on the NRG bus chain will have their BUS LED flashing to indicate that communication was established.

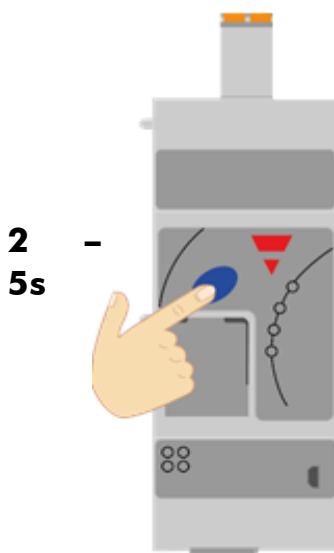

Figure 13 Press blue button for 2 - 5s to start / stop communications check

After finishing with the communications check it is important to turn it off by pressing again the blue button (2-5 secs) otherwise PLC cannot communicate with the NRG bus chain.

8.2 Replacing an RG..N

When an RG..N has to be replaced:

- 1) Connect the new RG..N to the bus chain.
- 2) Perform an auto-addressing function as explained in Section 3.3 or via an acyclic command.
- 3) If the same RG..N variant is used as the previous one (same part number), start-up parameters will be sent automatically upon start up of the PLC and communication should initiate.
- 4) If a new part-number is used, the PLC will only initiate communication with the RG..N if the current rating of the new device is higher, otherwise the RG..N will not be found on the communication interface.
- 5) If step 2 is accidentally skipped, an Unconfigured error shall automatically be triggered which would indicate that an auto-addressing is required.

Note: RG..N replacements should be performed with the system turned OFF.

8.3 Using the NRG system without 'REF' terminal connection

The NRG system can be utilised without connecting the 'REF' terminal however this will constitute some limitations as listed below:

- 1) The following readings are not available: RMS Voltage, Real Power and Apparent Power.
- 2) The 'TEACH' operation cannot be executed.
- 3) Voltage out of range and Load deviation alarms are not available.
- 4) The mains loss alarm cannot be discriminated from a load loss. Therefore, a mains loss alarm will indicate either a mains loss or a load loss.