



---

# CarPark 3

---

## Trouble-shooting guide

Rev. 4, 17/09/2021

---

# 1 INDEX

<b>1</b>	<b>INDEX .....</b>	<b>2</b>
<b>2</b>	<b>BEFORE SETTING UP AND ADDRESSING .....</b>	<b>3</b>
<b>2.1</b>	<b>MOUNTING SUGGESTIONS.....</b>	<b>3</b>
2.1.1	<i>SBPSUSL45 sensor .....</i>	3
2.1.1.1	Height and depth .....	3
2.1.1.2	Obstacles.....	4
2.1.1.3	Lateral obstacles .....	5
2.1.1.4	Increase reliability .....	5
2.1.2	<i>SBPSUSL sensor .....</i>	6
2.1.2.1	Height and depth .....	6
2.1.2.2	Obstacles.....	7
2.1.3	<i>SBPSUSCNT counter .....</i>	8
2.1.3.1	Minimum distance between sensors .....	8
2.1.3.2	Minimum distance between sensors .....	8
2.1.3.3	Mounting suggestions .....	8
2.1.3.4	Improving the mounting position .....	9
<b>2.2</b>	<b>WIRING .....</b>	<b>10</b>
2.2.1	<i>Cable .....</i>	10
2.2.2	<i>Start-up conditions.....</i>	11
2.2.3	<i>Diagnostic of LEDs of the SBP2MCG324 .....</i>	12
2.2.4	<i>No Dupline signal (or voltage drop exceeded) .....</i>	13
<b>2.3</b>	<b>GENERAL TROUBLE-SHOOTING.....</b>	<b>13</b>
<b>3</b>	<b>AFTER COMMISSIONING .....</b>	<b>14</b>
<b>3.1</b>	<b>GENERAL TROUBLE-SHOOTING.....</b>	<b>14</b>

## 2 BEFORE SETTING UP AND ADDRESSING

### 2.1 Mounting suggestions

This part of the manual deals with common problems the user can encounter during the installation of base-holders and sensors and possible mounting solutions are suggested.

#### 2.1.1 SBPSUSL45 sensor

##### 2.1.1.1 Height and depth

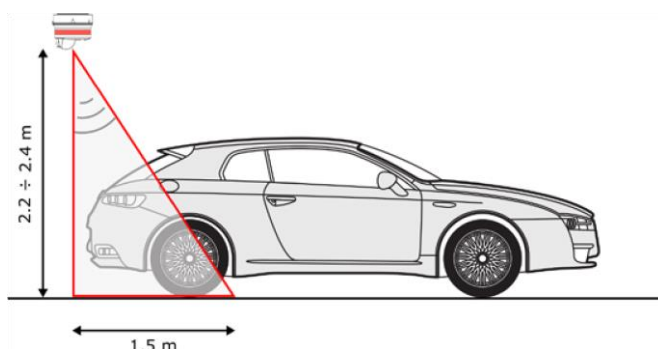

The sensor should be placed in the driving lane, pointing towards the parking bay:

- Height between 2.2 to 2.4m
- Depth of detection is 1.5 m

#### Height

The sensor is higher than the suggested height

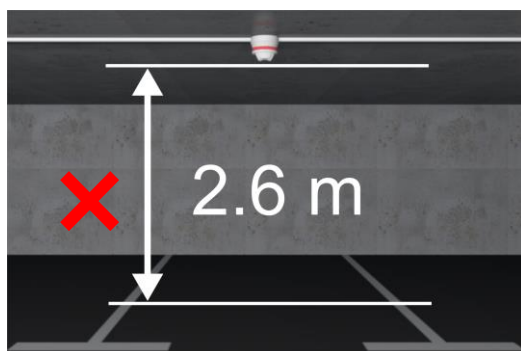

Use the SBPBASEA + pipe instead of the SBPBASEB

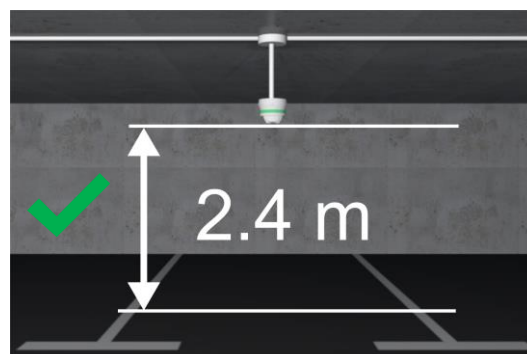

#### Mounting position

The sensor is too far from the parking bay



Put the sensor as closer as possible to the parking bay

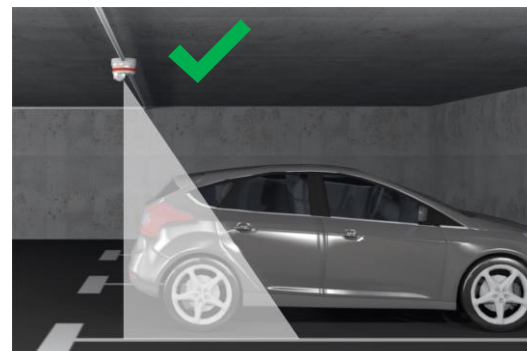

## 2.1.1.2 Obstacles

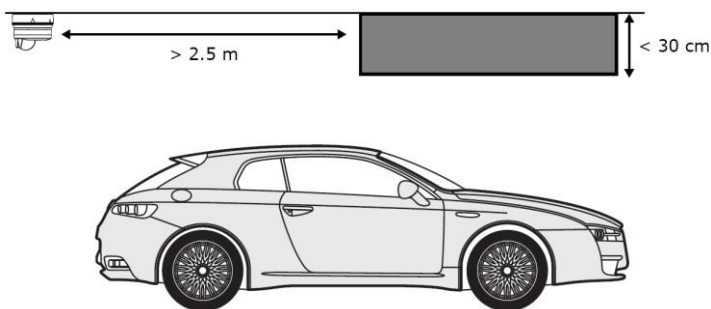

The obstacles on the ceiling (*pipes, beams, lamps, fans and ducts*) that might obstruct the sensor shall

- be at a min distance of 2.5 m (*if they are at the same height of the sensor*) or
- have max height/thickness of 30 cm

### The obstacle is close to the sensor

The sensor is obstructed by the obstacle (*LED lamp*)

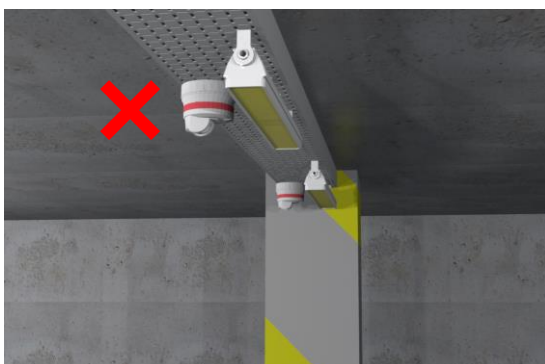

Put the sensor in front of the obstacle

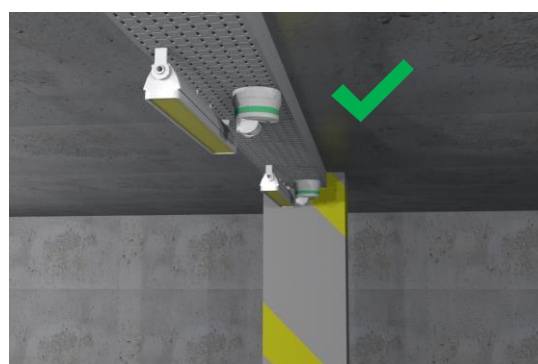

### The obstacle is lower than the sensor

The sensor is obstructed by the obstacle

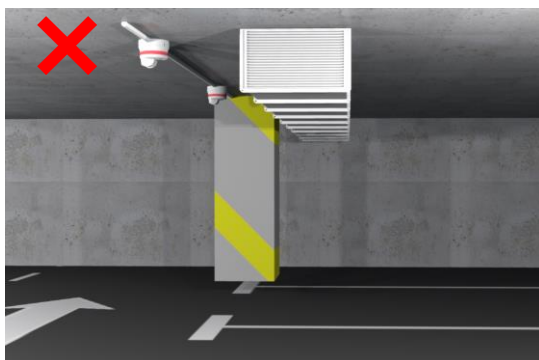

Put the SBPBASEA + sensor at least 5 cm below the obstacle

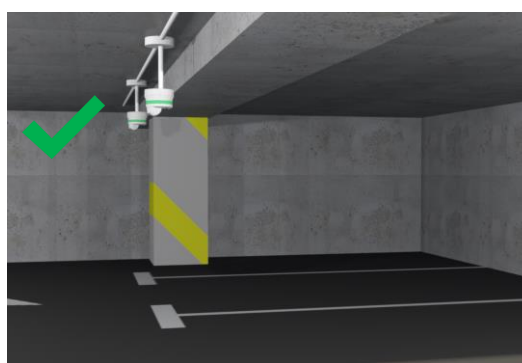
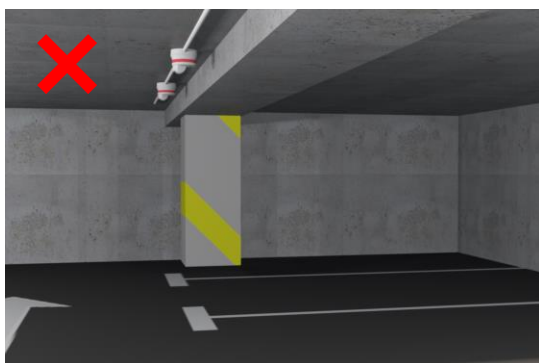
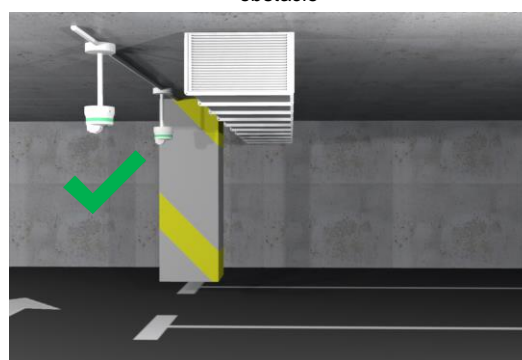

### 2.1.1.3 Lateral obstacles

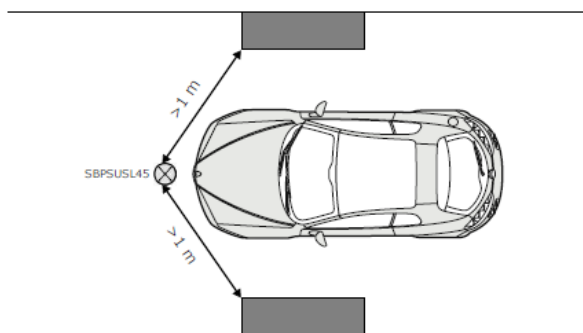

If the obstacles are on the side part of the sensor the distance between the obstacles and the sensor

- must be at least 1 m

If they are at the same height of the sensor, they must have a

- max thickness of 30 cm

#### Lateral obstacles

The obstacles are too close to the sensors

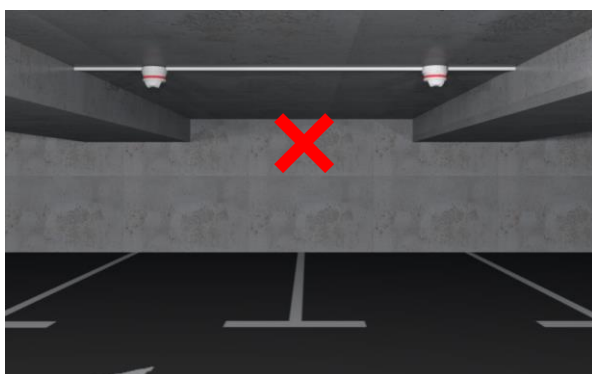

Put the SBPBASEA at least 5 cm below the obstacles

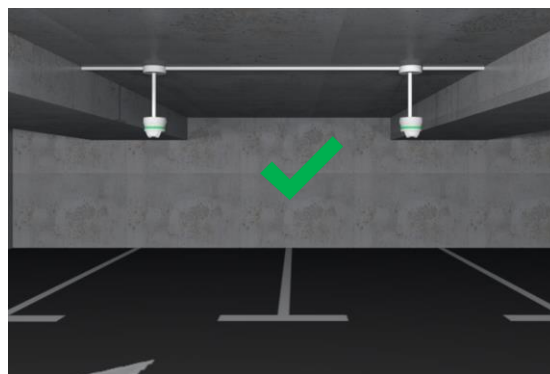

### 2.1.1.4 Increase reliability

To position properly the car in the parking bays, especially in the ones that are depth over 5 m, the wheel-stoppers are suggested.

#### Parking bay is too depth

The vehicle has been parked too far from the sensor



Wheel-stoppers avoid parking too far from the sensor



## 2.1.2 SBPSUSL sensor

### 2.1.2.1 Height and depth

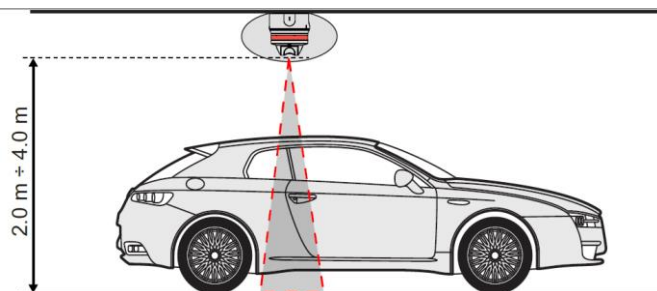

The sensor should be placed

- in the middle of the parking bay above the car
- at a height between 2.0 to 4.0 m

#### Height and depth

The sensor is higher than the suggested height

Use the SBPBASEA + pipe instead of the SBPBASEB

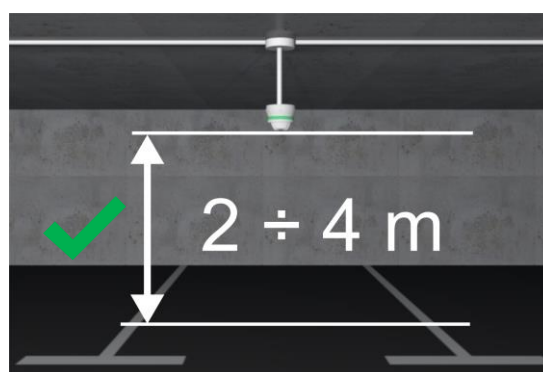
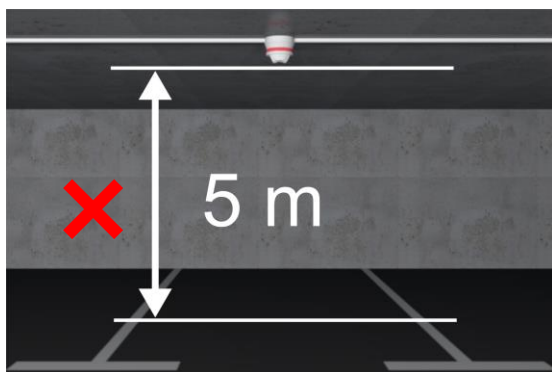

#### Mounting position

The sensor is wrongly mounted in the lane

The sensor is properly mounted in the middle of the parking bay above the car

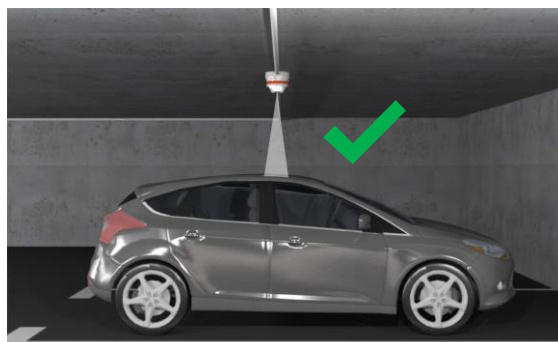

## 2.1.2.2 Obstacles

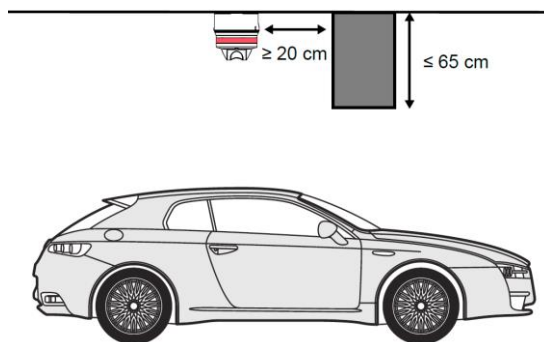

The obstacles on the ceiling (*pipes, beams, lamps, fans and ducts*) that might obstruct the sensor shall

- be at a min distance of 20 cm (*if they are at the same height of the sensor*) or
- have max height/thickness of 65 cm

### Lateral obstacles

The sensor is obstructed by the lateral obstacles



Put the SBPBASEA at least 5 cm below the obstacles



### The obstacle is under the sensor

The sensor is completely obstructed by the obstacle



The sensor is placed outside the obstacle by using the SBPBASEA and a pipe



The sensor is obstructed by the obstacle

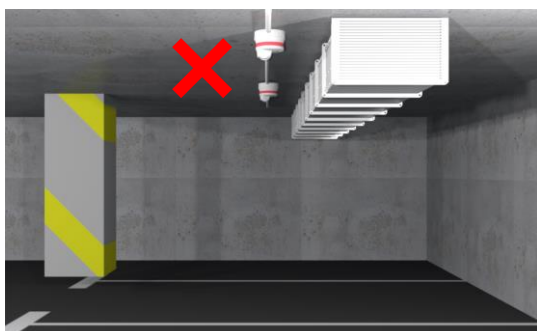

Put the SBPBASEA at least 5 cm below the obstacle



## 2.1.3 SBPSUSCNT counter

### 2.1.3.1 Minimum distance between sensors

The sensor should be mounted in the driving lane at a height between 2.0 to 2.5 m.

Refer to the table below to place two sensors at the proper distance:

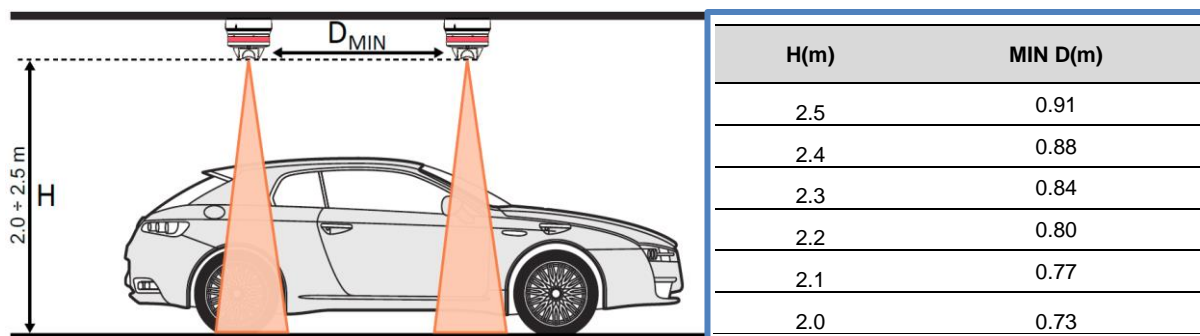

### 2.1.3.2 Minimum distance between sensors

Should the driving lane be larger than the standard (2.5 to 3.25 m), please refer to the table below to place the two sensors at the proper distance:

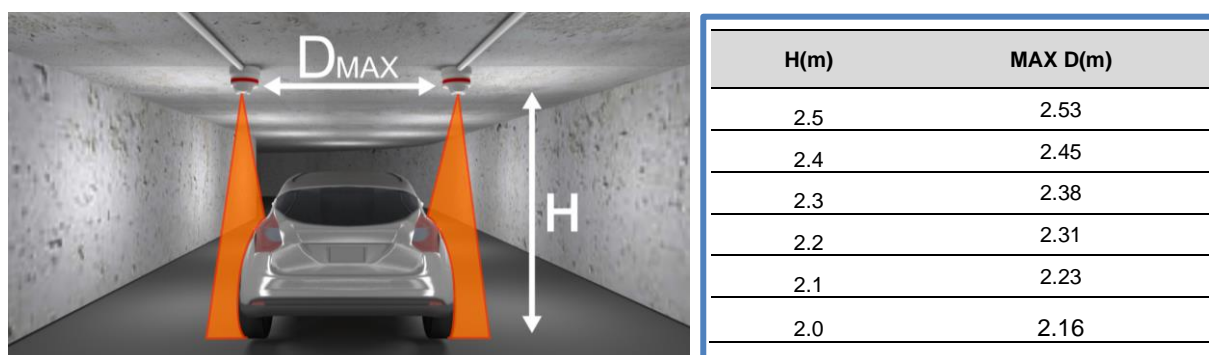

### 2.1.3.3 Mounting suggestions

#### Example 1

One of the sensors has been placed too far from the middle of the lane



The sensors are placed in the middle of the driving lane where the car passes





## Example 2

The car passes in the middle of the lane without activating any sensors

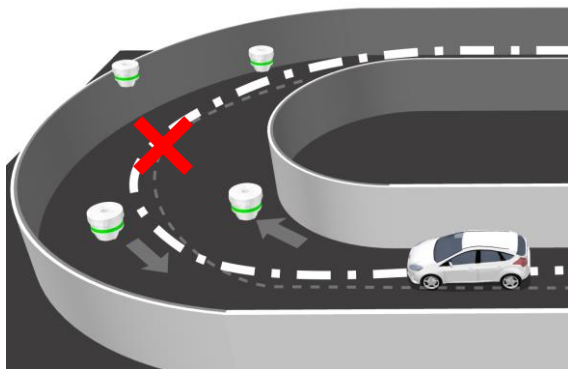

The delineator permits the correct counting for both the lanes

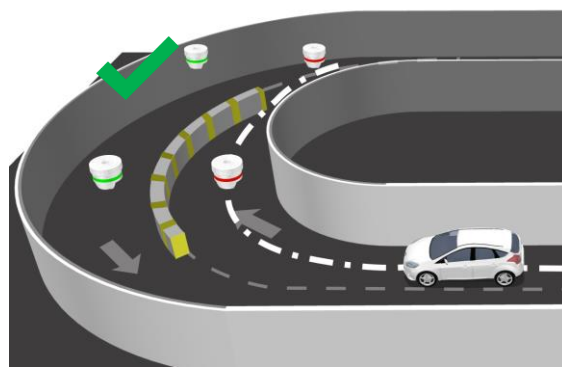

### 2.1.3.4 Improving the mounting position

To prevent queues from increasing/decreasing the counter wrongly, the SBPSUSCNT sensors should be placed in the center of the ramp among the floors instead of at the beginning/end.

#### Ramps among floors

The SBPSUSCNT sensors have been placed at the end of the ramp



The SBPSUSCNT sensors work properly if placed in the middle of the ramp

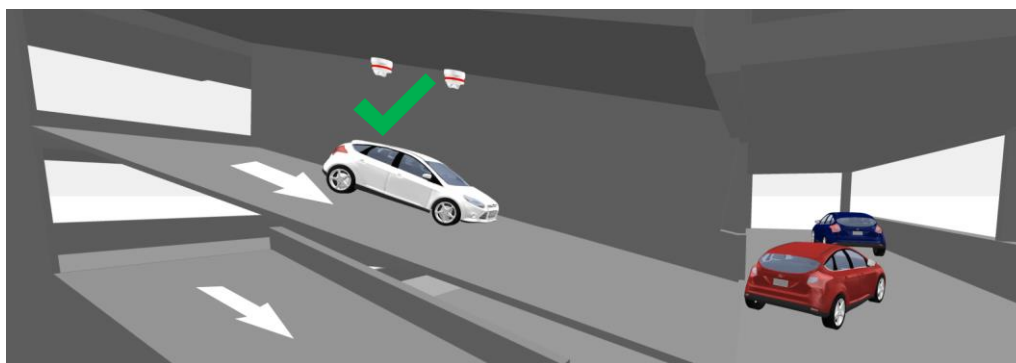

**Note:** Should queues be frequent in the areas where the SBPSUSCNT sensors are placed, a single-bay monitoring solution has to be considered by using the SBPSUSLxx sensors.



Ultrasonic technology does not work if the cars or the floor are covered by the snow.

## 2.2 Wiring

### 2.2.1 Cable

Use three 1.5 mm<sup>2</sup> (14-16AWG) single core wires for the sensors and LED indicators in the system. If the installer uses multi-core or stranded, the wires must be mounted with ferrules because of the push connectors in the sensor. If ferrules or single core cables are not used, the wires must be stripped correctly to avoid short circuits between them. Avoid stripping them too much.

#### Wrong wiring examples

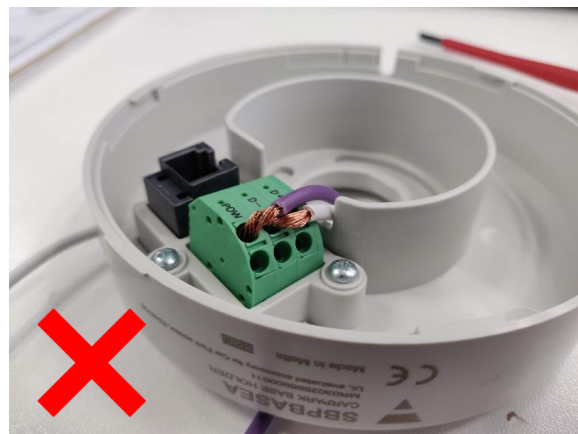
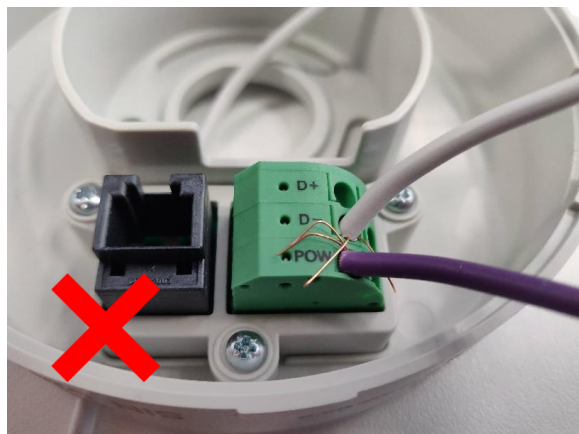

#### Right wiring indications



Leave some spare cable for each sensor (2/3 cm) in order to have enough cable to make the connection with the sensors connectors easier.

It is best to use 3-wire cables in order to decrease the possibility of mismatching the wires between sensors and between sensors and cabinet.

The good condition of the connectors must be maintained: if one connector is damaged, you must replace it. To disconnect wires from the connector, you should keep the connector on the base and press it with a screwdriver to release the wires.

## 2.2.2 Start-up conditions

- Impedance can be measured on the bus without connecting to the SBP2MCG324 module: between D-/POW and D+/POW there should be MOhm impedance, between D-/D+ there should be KOhm impedance. If this is not so, it means that some of the wiring is not correct. It could be a short circuit between the bus wires or their mismatching.
- The voltage output of the Dupline can be measured on the SBP2MCG324 and at the end of the lines: between D-/POW there should be 27/28 VDC and between D-/D+ there should be 6/8 VDC. If this is not so, it means that some of the wiring is not correct.
- Check that the HS-BUS and RS485 for displays are on two separate wires.

Possible wrong connections:

Connection	Terminals			Result
Correct Connection A	POW	D-	D+	Dupline communication works
Wrong connection 1	POW	D+	D-	Dupline communication does not work
<b>Wrong connection 2</b>	<b>D+</b>	<b>POW</b>	<b>D-</b>	<b>!!The sensor will burn out and it will be unusable!!</b>
Wrong connection 3	D+	D-	POW	The sensor does not work, but it will not break. (the sensor's LEDs are a weak red)
Wrong connection 4	D-	D+	POW	The sensor does not work, but it will not break
Wrong connection 5	D-	POW	D+	The Master Channel Generator goes into protection mode. There is no more communication, but nothing will break.

**Note: If a cable with more than three wires is used, the probability of having wrong voltages on the plugs is higher.**





## 2.2.3 Diagnostic of LEDs of the SBP2MCG324

In normal operating conditions, both the LEDs are steady. The table below shows the error conditions that can be identified by the LEDs:

LED	N° blink	Fault	Condition
Green	1	Controller hardware error	The SBP2MCG324 is damaged
Green	2	D+ voltage higher than expected	Voltage D+>9,5V, D+ could have been connected to POW
Yellow	1	D+/D- short circuit	/
Yellow	2	Pull down voltage high	One module could be missing the D-connection
Yellow	3	Dupline bus voltage error	Vdup<6V or Vdup > 9,5V
Yellow	4	Dupline bus overload	Dupline current is too high
Yellow	6	Module inverted	One module could be connected with D+/D-inverted

### Example

If one of the conditions above is verified, to find the sensor or the sensors that are causing the problem, we suggest that you do the analysis by bisection. The procedure below shows an example:

Step	Action
	The entire line of sensors connected to the channel generator is faulty
a	Entire line faulty 
1	Disconnect the second half of the line. If the first half is still faulty on the channel generator, then the problem must be on the first half
	Half line faulty 
2	Split the second half into two segments and keep only the first one connected. The first half is working
	Quarter of line OK 
3	Add one sensor to the other segment. If the line returns to faulty, then the sensor with the wrong connection has been identified
	Found 

## 2.2.4 No Dupline signal (or voltage drop exceeded)

1. If the D+ is not connected or the voltage drop on the Dupline bus exceeded, the LEDs of the sensor are white and stay white.
2. If the voltage drop is exceeded on the POW bus, the software tool will show voltage drop error on its interface; in this case the functionality of the sensor is not guaranteed and usually the LEDs of the sensor remain off.

## 2.3 General trouble-shooting

LEDs behaviour	How to solve the issue
Sensors flashing yellow	The addressing procedure has not been ended.
Sensor LEDs off	If the cables have already been checked, the problem could be a faulty base. Replace the actual sensor with a working one: if the new sensor is not working, the base is faulty.

## 3 AFTER COMMISSIONING

### 3.1 General trouble-shooting

This part of the manual deals with common problems the user can encounter during the project configuration or sensor calibration and, as shown below, possible solutions are suggested:

Problem	Solution
The sensor remains green and does not react	The sensor needs to be calibrated
The sensors respond too slowly or too quickly (unstable)	On the calibration window of the configuration tool <i>set the proper filter</i>
Display not showing anythings	Before working correctly, the display needs to be set up on the controller by means of the software tool and also set on the webserver interface
The sensor is not installed between 2.2m and 2.4m	On the calibration window of the configuration tool set the <i>Near End Position</i> field using the following formula: <i>Near End position = [ Height of the sensor – 0.2 m]</i>
The bay is narrower than 2.5m	On the calibration window of the configuration tool set the <i>Total Peak Out</i> field = 3
The bay is long, but without adjacent bays	On the calibration window of the configuration tool set the <i>Far End Position</i> field > 3.68m
Crosstalk	Identify the sensor which is creating crosstalk and modify its address  <i>Note: See <a href="#">CarPark manual</a> section 15.7</i>
Several sensors are not detecting: the status is always "occupied" or always "empty"	The SBP2WEB/UWP3.0 controller gives the synchronization to the SBP2MCG324 master channel generators connected to it. Without the synchronization signal, the sensors connected to the SBP2MCG324 cannot work correctly.  For this reason, the SBP2WEB/UWP3.0 controller must always be powered up. If the system needs to be powered off, when turning it on, <b>the SBP2WEB/UWP3.0 must be powered on together or before the SBP2MCG324.</b>

---

Displays are not updating  
their values

If everything has been correctly setup, the problem is due to a disconnection of the SBP2CPY from the SBP2WEB/UWP3.0 controller.

Check that the SBP2CPY is switched on and that the network connection to the SBP2WEB24/UWP3.0 is up and running.

---