

RA2A

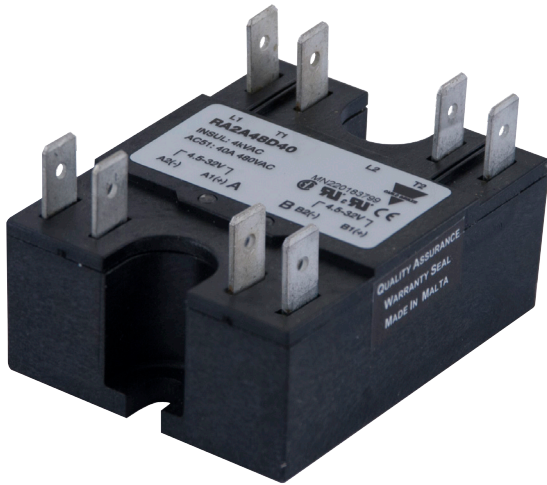

2-pole solid state relays



Main features

- AC switching solid state relay
- Zero cross switching
- Back to back thyristor output
- Direct copper bonding (DCB) technology
- For resistive and inductive AC loads
- DC control voltage
- LED for control presence indication for each independent pole
- 6.35 mm Faston termination for control and output terminals

Description

This 2-pole industrial relay minimises the space requirements in a control cabinet without compromising performance. By applying an input voltage on control A, the corresponding output semiconductor is activated at the first zero crossing of the line voltage. The same applies to control B.

LEDs indicate the control status of each pole. The optimised design is free of moulding mass to reduce internal mechanical stress.

The RA2A..M types have been specially customised for demanding inductive loads.

Specifications are at a surrounding temperature of 25°C unless otherwise specified.

Applications

Plastic injection machines, extrusion machines, blow moulding machines, thermoformers, coffee machines, electrical ovens, fryers, shrink tunnels, reflow ovens.

Main functions

- 2 independent pole switching solid state relay
- Zero cross switching
- Ratings up to 600 VAC, 40 AAC per pole
- 4.5 - 32 VDC control voltage range

Order code



Enter the code option instead of . Refer to selection guide section for valid part numbers.

Code	Option	Description	Comments
R	-	Solid State Relay (RA)	
A	-		
2	-	2-pole switching	
A	-	Zero cross switching (ZC)	
<input type="checkbox"/>	23	Rated voltage: 24-265 VAC, 650 Vp	
	48	Rated voltage: 42-530 VAC, 1200 Vp	
	60	Rated voltage: 42-660 VAC, 1200 Vp	
D	-	Control voltage: 4.5 - 32 VDC	
<input type="checkbox"/>	25	Rated current: 2 x 25 AAC	
	40	Rated current: 2 x 40 AAC	
<input type="checkbox"/>	-	Type: Resistive load	
	M	Type: Inductive load	

Selection guide

Rated voltage, Blocking voltage	Switching mode	Control voltage	Maximum rated operational current*	
			2 x 25 AAC	2 x 40 AAC
230 VAC, 650 Vp	Zero cross	4.5 - 32 VDC	RA2A23D25	RA2A23D40
480 VAC, 1200 Vp			RA2A23D25M	RA2A23D40M
			RA2A48D25	RA2A48D40
600 VAC, 1200 Vp			RA2A48D25M	RA2A48D40M
			RA2A60D25	RA2A60D40
			RA2A60D25M	RA2A60D40M

* With suitable heatsink.

Carlo Gavazzi compatible components

Description	Component code	Notes
Graphite thermal pad	KK071CUT	- Dimensions: 35 x 43 x 0.25 mm - Packing quantity: 50 pcs.
Heatsink	RHS	Heatsinks and accessories

Carlo Gavazzi further reading

Information	Where to find it	Notes
Datasheet	https://gavazziautomation.com/images/PIM/DATASHEET/ENG/SSR_Accessories.pdf	Accessories datasheet
	https://gavazziautomation.com/nsc/hq/en/solid_state_relays	Online Heatsink selector tool

Structure

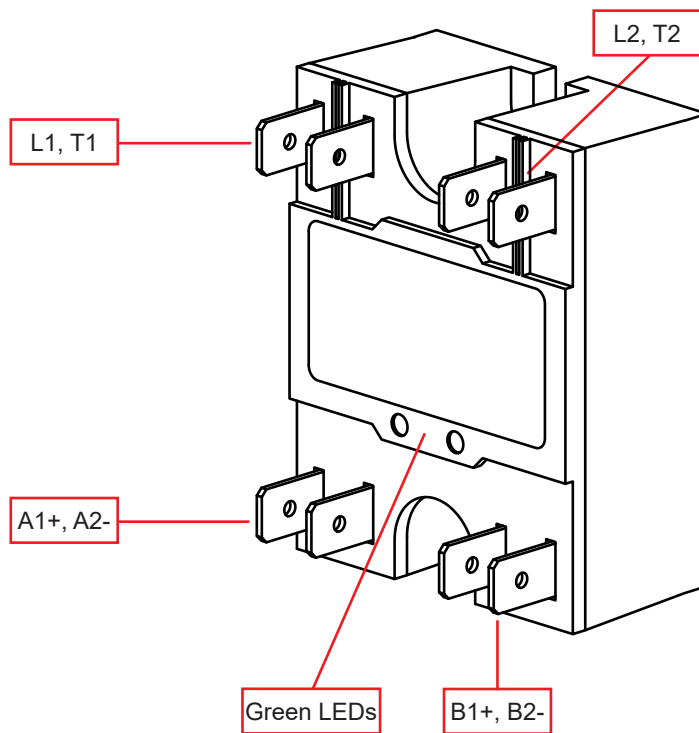

Element	Component	Function
L1, T1	Power connections	Mains and load connections for pole A
L2, T2	Power connections	Mains and load connections for pole B
A1+, A2-	Control connection	Terminals for control voltage for pole A
B2+, B2-	Control connection	Terminals for control voltage for pole B
Green LEDs	Control indicator	Indicates presence of control voltage (pole A and pole B)

Features

General data

Material	Noryl GFN 1, black	
Mounting	Panel mount	
Base plate 25, 40 A 40 A (M type)	Aluminium, nickel-plated Copper, nickel-plated	
Isolation	Input and Output to Case Input to Output	4000 Vrms 4000 Vrms
Weight	RA2A23.. RA2A48..., RA2A60..	approx. 60g approx. 64g
FASTON terminal size	6.35 x 0.8 mm	
Relay Mounting screws Mounting torque	M5 1.5 - 2.0 Nm	

Dimensions

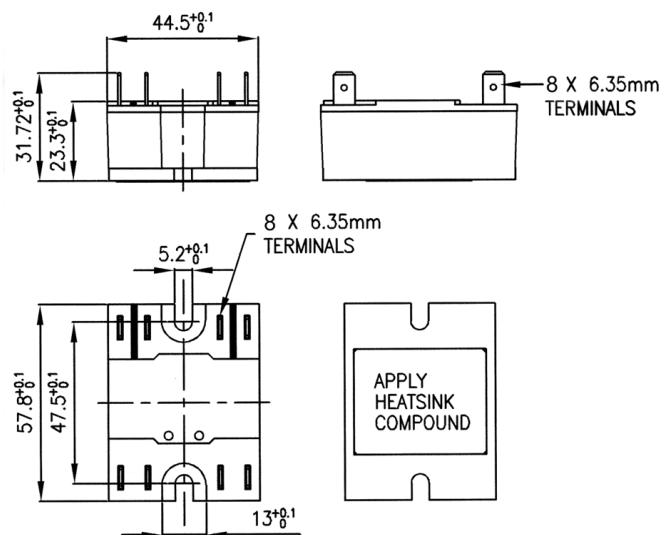

Dimensions in mm unless otherwise noted.
Tolerances +/- 0.5mm.

Performance

Output specifications

	RA2A...25	RA2A...40	RA2A...25M	RA2A...40M
Max. operational current: AC-51	2 x 25 AACrms	2 x 40 AACrms	2 x 25 AACrms	2 x 40 AACrms
Max. operational current: AC-53a	-	-	2 x 5 AACrms	2 x 15 AACrms
Operational frequency range	45 to 65 Hz			
Leakage current @ rated voltage	< 3 mA			
Power factor RA2A RA2A..M	≥ 0.95 @ rated voltage ≥ 0.50 @ rated voltage			
Minimum operational current	150 mA	250 mA	150 mA	250 mA
Non-repetitive surge current (I_{TSM}), t=10 ms	325 Ap	600 Ap	325 Ap	600 Ap
I^2t for fusing (t=10 ms), min.	525 A ² s	1800 A ² s	525 A ² s	1800 A ² s
Critical dV/dt (@T _j init = 40°C)	500 V/μs			

Output voltage specifications

	RA2A23...	RA2A48...	RA2A60...
Operational voltage range, U _e	24 to 265 VACrms	42 to 530 VACrms	42 to 660 VACrms
Blocking voltage	650 Vp	1200 Vp	1200 Vp

Inputs

Control voltage range	4.5 - 32 VDC
Pick-up voltage	4.25 VDC
Drop-out voltage	2.0 VDC
Maximum reverse voltage	32 VDC
Response time pick-up @ 50 Hz	≤10 ms
Response time drop-out @ 50 Hz	≤10 ms
Input current per pole @ max. input voltage	≤10 mA

Output power dissipation

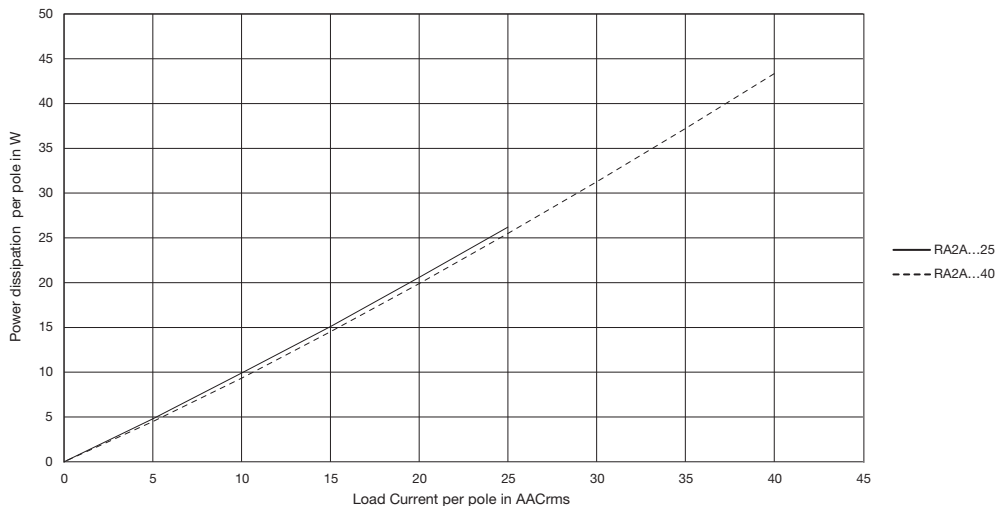

Applications

Care must be taken to ensure proper heatsinking when the relay is to be used at high sustained currents. Adequate electrical connection between relay terminals and cable must be ensured.

Thermal characteristics

The thermal design of solid state relays is very important. It is essential that the user makes sure that cooling is adequate and that the maximum junction temperature of the relay is not exceeded.

If the heatsink is placed in a small closed room, control panel or the like, the power dissipation can cause the ambient temperature to rise. The heatsink is to be calculated on the basis of the ambient temperature and the increase in temperature.

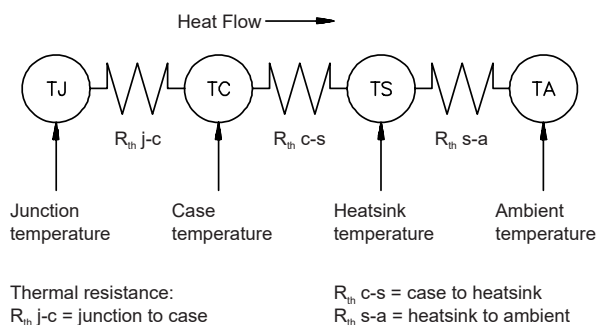

Heatsink selection

Thermal resistance [°C/W] of RA2A...25/25M

Load current [A]	Surrounding ambient temperature [°C]					
	20	30	40	50	60	70
50	1.11	0.94	0.78	0.62	0.46	0.29
45	1.36	1.17	0.99	0.80	0.61	0.43
40	1.68	1.47	1.25	1.03	0.81	0.60
35	2.06	1.80	1.54	1.29	1.03	0.77
30	2.5	2.2	1.87	1.56	1.25	0.94
25	3.1	2.7	2.3	1.9	1.6	1.17
20	4.0	3.5	3.0	2.5	2.0	1.52
15	6.0	5.0	4.0	3.5	2.8	2.1
10	9.0	8.0	7.0	6.0	4.0	3.3
5	18.0	16.0	14.0	12.0	9.0	7.0

Thermal resistance [°C/W] of RA2A...40

Load current [A]	Surrounding ambient temperature [°C]					
	20	30	40	50	60	70
80	0.68	0.56	0.44	0.32	0.19	0.07
72	0.87	0.73	0.59	0.45	0.31	0.17
64	1.10	0.94	0.78	0.62	0.45	0.29
56	1.41	1.22	1.03	0.83	0.64	0.45
48	1.8	1.6	1.36	1.13	0.90	0.67
40	2.3	2.0	1.7	1.4	1.1	0.86
32	3.0	2.6	2.2	1.9	1.5	1.1
24	4.0	4.0	3.0	2.6	2.0	1.5
16	6.0	6.0	5.0	4.0	3.0	2.4
8	13.0	12.0	10.0	8.0	7.0	5.0

Thermal resistance [°C/W] of RA2A...40M

Load current [A]	Surrounding ambient temperature [°C]					
	20	30	40	50	60	70
100	0.41	0.32	0.23	0.13	0.04	-
90	0.55	0.44	0.34	0.23	0.13	0.02
80	0.72	0.60	0.48	0.35	0.23	0.11
70	0.95	0.80	0.66	0.52	0.37	0.23
60	1.25	1.08	0.90	0.73	0.56	0.39
50	1.7	1.5	1.25	1.04	0.83	0.61
40	2.2	1.9	1.6	1.4	1.1	0.82
30	3.0	2.7	2.3	1.9	1.5	1.14
20	5.0	4.0	4.0	2.9	2.3	1.8
10	10.0	9.0	7.0	6.0	5.0	3.6
5	20.0	17.0	15.0	12.0	10.0	7.0







Note: Add the currents of both poles and compare with datasheets for proper heatsink. Each pole can handle up to the maximum current specified.

Example: Each pole of the RA2A23D25 can handle a maximum of 25 A.

Thermal data

	RA2A...25.	RA2A...40	RA2A...40M
Junction temperature	≤ 125°C	≤ 125°C	≤ 125°C
R _{th} junction to case 1 pole 2 pole	1°C/W 0.5°C/W	1°C/W 0.5°C/W	0.92°C/W 0.46°C/W
R _{th} junction to ambient	≤ 20°C/W	≤ 20°C/W	≤ 20°C/W

Compatibility and conformance

Approvals	     
Standards compliance	LVD: EN 60947-4-3 EMCD: EN 60947-4-3 EE: EN 60947-4-3 EMC: EN 60947-4-3 UR: UL508 Recognised (E80573), NRNT2 cUR: C22.2 No. 14 (E80573), NRNT8 CSA: C22.2 No. 14 (204075)
UL short circuit current rating	65 kArms (refer to short circuit current section, Type 1 – UL508)

Electromagnetic compatibility (EMC) - Immunity	
Electrostatic discharge (ESD)	EN/IEC 61000-4-2 8 kV air discharge, 4 kV contact (PC2)
Radiated radio frequency	EN/IEC 61000-4-3 10 V/m, from 80 MHz to 1 GHz (PC1) 10 V/m, from 1.4 to 2 GHz (PC1) 3 V/m, from 2 to 2.7 GHz (PC1)
Electrical fast transient (burst)	EN/IEC 61000-4-4 Output: 2 kV, 5 kHz (PC2) Input: 1 kV, 5 kHz (PC1)
Conducted radio frequency	EN/IEC 61000-4-6 10 V/m, from 0.15 to 80 MHz (PC1)
Electrical surge	EN/IEC 61000-4-5 Output, line to line: 1 kV (PC2) Output, line to earth: 1 kV (PC2) Output, line to earth: 2 kV (PC2) with external varistor Input, line to line: 1 kV (PC2) Input, line to earth: 2 kV (PC2)
Voltage dips	EN/IEC 61000-4-11 0% for 0.5, 1 cycle (PC2) 40% for 10 cycles (PC2) 70% for 25 cycles (PC2) 80% for 250 cycles (PC2)
Voltage interruptions	EN/IEC 61000-4-11 0% for 5000 ms (PC2)

Electromagnetic compatibility (EMC) - Emissions	
Radio interference field emission (radiated)	EN/IEC 55011 Class A: from 30 to 1000 MHz
Radio interference voltage emissions (conducted)	EN/IEC 55011 Class A (Industrial) with external filters: from 0.15 to 30 MHz

Note:

- The power circuit to this component may require external suppression to be connected across the power terminals.
- Control input lines must be installed together to maintain products' susceptibility to Radio Frequency interference.
- Performance Criteria 1 (PC1): No degradation of performance or loss of function is allowed when the product is operated as intended.
- Performance Criteria 2 (PC2): During the test, degradation of performance or partial loss of function is allowed. However when the test is complete the product should return operating as intended by itself.
- Performance Criteria 3 (PC3): Temporary loss of function is allowed, provided the function can be restored by manual operation of the controls.

Environmental specifications

Operating temperature	-20°C to +70°C (-4°F to +158°F)
Storage temperature	-20°C to +80°C (-4°F to +212°F)
Relative humidity	95% non-condensing @ 40°C
Pollution degree	2
EU RoHS compliant	Yes
China RoHS	

The declaration in this section is prepared in compliance with People's Republic of China Electronic Industry Standard SJ/T11364-2014: Marking for the Restricted Use of Hazardous Substances in Electronic and Electrical Products.

Part Name	Toxic or Harardous Substances and Elements					
	Lead (Pb)	Mercury (Hg)	Cadmium (Cd)	Hexavalent Chromium (Cr(VI))	Polybrominated biphenyls (PBB)	Polybrominated diphenyl ethers (PBDE)
Power Unit Assembly	x	0	0	0	0	0

O: Indicates that said hazardous substance contained in homogeneous materials for this part are below the limit requirement of GB/T 26572.

X: Indicates that said hazardous substance contained in one of the homogeneous materials used for this part is above the limit requirement of GB/T 26572.

这份申明根据中华人民共和国电子工业标准
SJ/T11364-2014：标注在电子电气产品中限定使用的有害物质

零件名称	有毒或有害物质与元素					
	铅 (Pb)	汞 (Hg)	镉 (Cd)	六价铬 (Cr(VI))	多溴化联苯 (PBB)	多溴联苯醚 (PBDE)
功率单元	x	0	0	0	0	0

O:此零件所有材料中含有的该有害物低于GB/T 26572的限定。

X: 此零件某种材料中含有的该有害物高于GB/T 26572的限定。

Short circuit protection

Protection Co-ordination, Type 1 vs Type 2:

Type 1 protection implies that after a short circuit, the device under test will no longer be in a functioning state. In type 2 coordination the device under test will still be functional after the short circuit. In both cases, however, the short circuit has to be interrupted. The fuse between enclosure and supply shall not open. The door or cover of the enclosure shall not be blown open. There shall be no damage to conductors of terminals and the conductors shall not separate from terminals. There shall be no breakage or cracking of insulating bases to the extent that the integrity of the mounting of live parts is impaired. Discharge of parts or any risk of fire shall not occur.

The product variants listed in the table hereunder are suitable for use on a circuit capable of delivering not more than 65,000 Arms Symmetrical Amperes, 600 Volts maximum when protected by fuses. Tests at 65,000 A were performed with Class J, fast acting: please refer to the table below for maximum allowed ampere rating of the fuse. Use fuses only.

Protection co-ordination Type 1 according to UL 508				
Part No.	Prospective short circuit current [kArms]	Max. fuse size [A]	Class	Voltage [VAC]
RA2A..25..	65	30	J / CC	Max. 600
RA2A..40..		40	J	
		20	HSJ20 (Mersen)	

Protection co-ordination Type 2 (IEC/EN 60947-4-3)				
Part No.	Prospective short circuit current [kArms]	Ferraz Shawmut (Mersen)		Voltage [VAC]
		Max. fuse size [A]	Part number	
RA2A..25..	10	25	6.9 gRC 10- 25	Max. 600
RA2A..40..		40	6.9xx CP gRC 14x51/40	

xx= 00 without fuse trip indication

xx = 21 with fuse trip indication

Protection co-ordination Type 2 with Miniature Circuit Breakers (M.C.B.s)				
Solid State Relay type	ABB Model no. for Z - type M. C. B. (rated current)	ABB Model no. for B - type M. C. B. (rated current)	Wire cross sectional area [mm ²]	Minimum length of Cu wire conductor [m] ¹
RA2A..25 (525 A ² s)	1-pole S201 - Z4 (4A) S201 - Z6 UC (6A)	S201 - B2 (2A) S201 - B2 (2A)	1.0	21.0
			1.0	21.0
			1.5	31.5
RA2A..40 (1800 A ² s)	1-pole S201 - Z10 (10A)	S201 - B4 (4 A)	1.0	7.6
			1.5	11.4
			2.5	19.0
	S201 - Z16 (16A)	S201 - B6 (6 A)	1.0	5.2
			1.5	7.8
			2.5	13.0
			4.0	20.8
	S201 - Z20 (20A)	S201 - B10 (10 A)	1.5	12.6
			2.5	21.0
	S201 - Z25 (25A)	S201 - B13 (13 A)	2.5	25.0
4.0			40.0	
2-pole S202 - Z25 (25A)	S202 - B13 (13 A)	2.5	19.0	
		4.0	30.4	

1. Between MCB and Load (including return path which goes back to the mains)

Note: A prospective current of 6 kA and a 230 / 400 V power supply is assumed for the above suggested specifications. For cables with different cross section than those mentioned above please consult Carlo Gavazzi's Technical Support Group.

S201 models refer to 1-pole M.C.B., S202 models refer to 2-poles M.C.B.

▶ Functional diagram

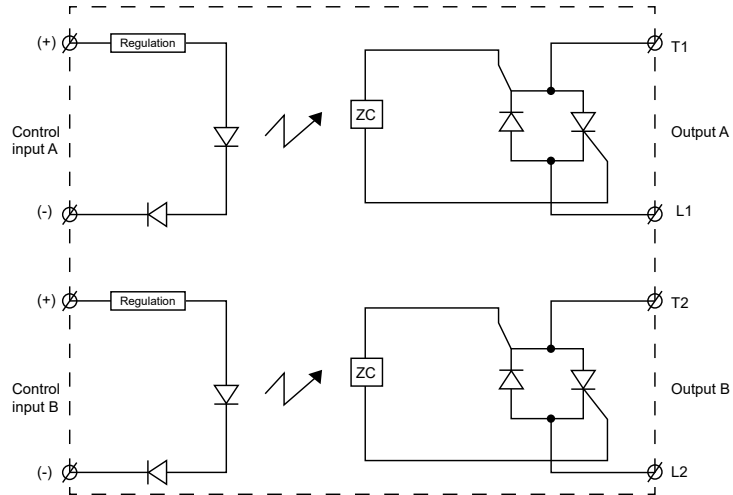

Connection Diagram

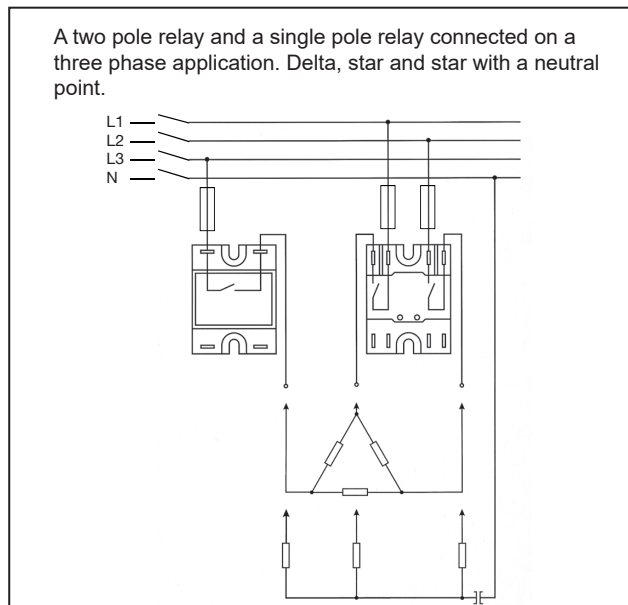
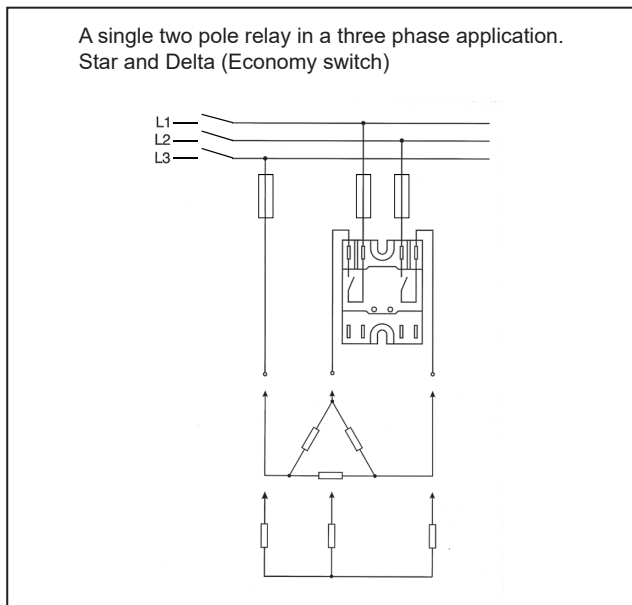

COPYRIGHT ©2022
Content subject to change.
Download the PDF: <https://gavazziautomation.com>