

# Dupline® DeviceNet Gateway Type G 3891 0050



- Built-in Dupline® channel generator
- DeviceNet slave
- DeviceNet communication speed of up to 500 kBaud
- Read/control of 128 Dupline® inputs/outputs through DeviceNet
- Split-I/O mode selectable (128 inputs *and* 128 outputs)
- Support of 3 1/2 digit BCD and AnaLink analog formats
- All Dupline® formats (except 8 bit binary multiplexed) available on the DeviceNet network
- For mounting on DIN-rail (EN 50 022)
- LED indicators for supply, Dupline® carrier and fault
- AC power supply

## Product Description

Dupline® Channel Generator with the function of a DeviceNet slave. This means that the 128 Dupline® I/O's can be read/controlled by DeviceNet masters (PLC's, PC

interface cards, etc. from various suppliers). Several Dupline® gateways can be connected to the same DeviceNet network.

## Type Selection

Supply	Ordering no.
115/230 VAC	G 3891 0050

## Ordering Key

**G 3891 0050 230**

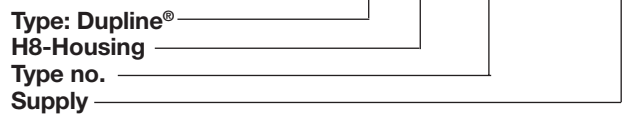

## Input/Output Specifications

<b>DeviceNet</b> Pin assignment V- CAN-L SHIELD CAN-H V+ Baudrate Cable length (Thick cable) Update time (128 digital I/O) Dielectric voltage DeviceNet Dupline® EDS-file	Pin 1 Pin 2 Pin 3 Pin 4 Pin 5 Switch settings 100 m @ 500 kBaud 200 m @ 250 kBaud 1200 m @ 125 kBaud Typ. 200 µs at 560 kBaud Typ. 1.6 ms at 125 kBaud ≥ 4 kVAC (rms)	<b>Adjustments</b> 1 x 16 pos. rotary switch DIP-switch 1 DIP-switch 2 DIP-switch 3 DIP-switch 4 <b>CE-marking</b>	No. of Dupline® channels 8 .. 128 in steps of 8 Dupline® mode (Normal/Split I/O) Dupline® data transfer mode Analog input Analog output Yes
<b>Dupline®</b> Output voltage Output current Short-circuit protection All channels ON detector Output impedance Sequence time 8 digital I/O 128 digital I/O AnaLink value update time 8 signals 128 signals	8.2 V ≤ 100 mA Yes Yes ≤ 15 Ω 15.2 ms 132.3 ms 3.9 s 33.8 s		

## General Specifications

<b>Power ON delay</b>	< 2.5 s until start of Dupline® carrier. < 40 s until correct reading of AnaLink values
<b>Indication for</b>	
Supply ON	LED, green
Dupline® carrier	LED, yellow
Fault	LED, red
<b>Environment</b>	
Degree of protection	IP 20
Pollution degree	3 (IEC 60664)
Operating temperature	0° to +50°C (+32° to +122°F)
Storage temperature	-20° to +85°C (-4° to +185°F)
<b>Humidity (non-condensing)</b>	20 to 80% RH
<b>Mechanical resistance</b>	
Shock	15 G (11 ms)
Vibration	2 G (6 to 55 Hz)
<b>Dimensions</b>	H8-housing
<b>Material</b>	(see Technical information)
<b>Weight</b>	540 g

## Supply Specifications

<b>Power supply</b>	Overvoltage cat. III (IEC 60664)
Rated operational voltage	See wiring diagram
through term. 21, 22, 23 & 24	230 VAC ± 15% (IEC 60038)
230	115 VAC ± 15% (IEC 60038)
115	45 to 65 Hz
Frequency	11 VA
Rated operational power	4 kV
Rated impulse withstand voltage	2.5 kV
230	
115	
Dielectric voltage	
Supply - Dupline®	≥ 4 kVAC (rms)
Supply - RS 485	≥ 4 kVAC (rms)

## Wiring Diagrams

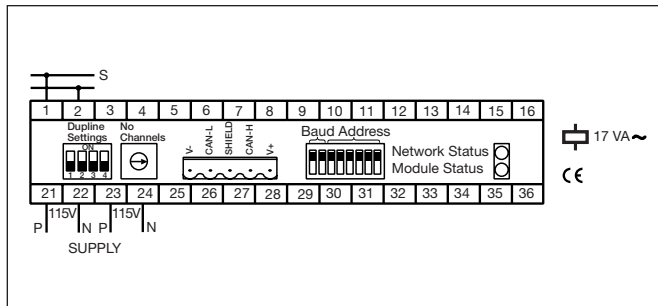
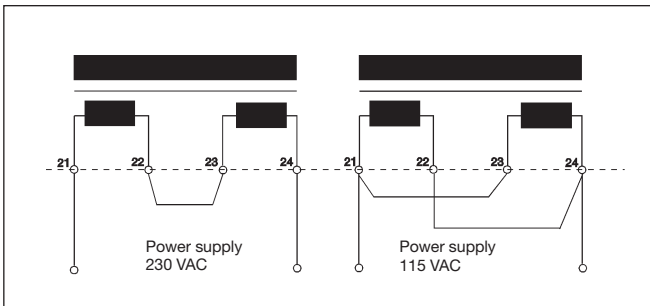

## Mode of Operation

The Dupline® DeviceNet Gateway is a Dupline® Channel generator with a function of a DeviceNet slave. This means that the 128 Dupline® I/O's can be read/controlled by DeviceNet masters like PLC's and PC interface-cards from many different suppliers. Several Dupline® Gateways can be connected to the same network and operate together with other DeviceNet modules like operatorpanels, MMI's I/O modules etc.

### Configuration switches

The unit is equipped with the following configuration switches. (See also switch settings)

**1x16 position rotary-switch** for selecting Number of Dupline® Channels in the range 8..128 (in steps of 8). The selected letter indicates the last channel group available on Dupline®. If e.g. H is selected, the 64 channels in groups A..H will be available.

**1x DIP-switch** for selection of Dupline® Operation Mode. In "Normal" mode, Dupline® operates as a peer-to-peer system where the channel generator automatically establishes a connection between Dupline® inputs and Dupline® outputs which are coded to the same Dupline® address. If e.g. an input coded for B5 is activated, the

output(s) coded for B5 will also be activated. Consequently, a Dupline® output can either be activated through the output-data received on DeviceNet or by an active Dupline® input coded for the same Dupline® address. In "Split I/O" mode, the Dupline® inputs and Dupline® outputs are treated independently by the channel generator. If e.g. and input coded for B5 is activated, the Gateway will make the information available on DeviceNet (like in normal mode), but it will not automatically activate the Dupline® output(s) coded to B5. The Dupline® outputs are controlled exclusively through the output data

received on DeviceNet.

**1x DIP-switch** for selection of analog data. In OFF position only Digital In/Out data are transferred. To enable analog data-I/O handling this DIP-switch must be ON.

**1x DIP-switch** for selection of Analog input operation mode. When OFF the analog input data are read as AnaLink. Each channel from C1 to P8 are read as 8 bit analog data. When ON the analog input data are considered as 3 1/2 digit multiplexed data. The multiplex-control (Synchronization) are automatically set to operate on channels

## Mode of Operation (cont.)

A1..A4 which then can not be used for other purposes.

1xDIP-switch for selection of Analog Output operation mode.

When OFF the Analog output are emitted as AnaLink.

When ON the Analog Output-data are emitted as 3 1/2 digit Multiplexed data, and channels A1..A4 will control the multiplex addressing .

### Dupline® Input Data

A part of the Gateway input-processor reads all the 128 Dupline®-channels as Digital

inputs (16 bytes) and another part reads the 112 channels (C1 to P8) as Analog inputs and performs the appropriate scaling of input data. Each Analog value are represented as a 16 bit word with MBS as sign and 15 bits of magnitude. This results in a total of 224 bytes containing all analog input-data.

All data are mapped with Digital input bytes starting at relative address 00 followed by the analog data. See In/out data mapping.

### Dupline® Output Data

Digital Output data are handled in accordance with the Dupline® Operation Mode: Split I/O or Normal. Analog data are handled and scaled in accordance to Analog Output operation mode.

When Analog Output is selected, care should be taken to avoid a mix of Digital and analog output data.

The AnaLink Outputs a series of pulsating 1's and 0's and for the value of zero, a basic 8 pulse-train will be outputted, for enabling the

receivers to detect validity. When outputting Multiplexed Analog, two bits are output for format-check.

To disable analog outputs, write a value of -32767 (0xFFFF) in all locations where only digital data should be. If eg. channels O1 .. P8 are desired as purely digital data, all analog data bytes mapped from relative address 0xD0 to 0xEF should be written the value 0xFF.

## Relative Addressing of Input/Output Data

### Input/Output area

adr:			
00:	A-P	Digital	16 bytes
10:	C-D	Analog	32 bytes
30:	E-F	Analog	32 bytes
50:	G-H	Analog	32 bytes
70:	I-J	Analog	32 bytes
90:	K-L	Analog	32 bytes
B0:	M-N	Analog	32 bytes
D0:	O-P	Analog	32 bytes

### Digital data

Adr:	MSB	LSB
00:	A1.	A8
01:	B1.	
02:		

### Analog data

Adr:	
10-11:	C1: AnaLink or C-D mux 0
12-13:	C2: AnaLink or C-D mux 1
2E-2F:	D8: AnaLink or C-D mux 15

Analog data format:	
Adr: 10	11
Bits: 7.6.5.4.3.2.1.0	7.6.5.4.3.2.1.0
0: positive	
1: negative = Disabled	

## Pin Assignment - DeviceNet Connector

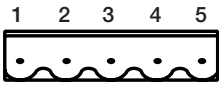

### BUS connector

Plugable connector	Screw terminals	Description
1	1	V-
2	2	CAN-L
3	3	SHIELD
4	4	CAN-H
5	5	V+

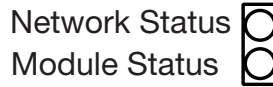

Module errors are indicated with the Module status LED and Network status LED

LED's	Description
Module-Status, steady off	No power
Module-Status, steady red	Unrecoverable fault
Module-Status, steady green	Device Operational
Module-Status, flashing red	Minor fault
Network-Status, steady off	Not Powered/Not on line
Network-Status, steady green	Link OK on line, Connected
Network-Status, steady red	Critical Link failure
Network-Status, flashing green	On line not connected
Network-Status, flashing red	Connection Time Out

## Switch Settings

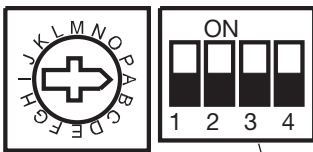

**Number of Dupline Channels**  
 A: Group A 8 channels  
 B: Groups A..B 16 channels  
 P: Groups A..P 128 channels

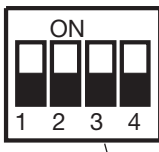

**1: Dupline Operation Mode**  
 OFF: Normal (Peer-to-Peer)  
 ON: Split I/O mode

**2: Dupline Data Transfer mode**  
 OFF: Digital  
 ON: Analog

**3: Analog Input protocol**  
 OFF: AnaLink  
 ON: Multiplex

**4: Analog Output protocol**  
 OFF: AnaLink  
 ON: Multiplex

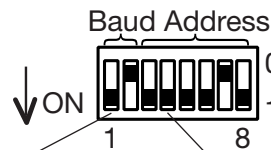

Baudrate bit/s	Set DIP 1-2
125k	00
250k	01
500k	10
Reserved	11

Address	Set DIP 3-8
0	000000
1	000001
2	000010
61	111101
62	111110
63	111111

## Dimensions (mm)

### H8-housing

