

# DPB01, PPB01



## True RMS 3-Phase voltage monitoring relay



### Benefits

- **Wide voltages and frequency ranges.** Working in systems from 208 to 480 VAC and 50 to 400 Hz.
- **Adjustable voltage levels and time delay.** To allow a correct response to real alarm conditions.
- **Output and status LED indication.** For quick troubleshooting.
- **Two mounting versions.** Available for DIN-rail (DPB01) and Plug-in (PPB01) mounting.
- **Adjustable power ON delay.** To avoid nuisance tripping at start-up.
- **Ultra-high harmonic immunity.** For very noisy environments.

### Description

DPB01 and PPB01 are 3-phase mains monitoring relays.

They operate on 3P and 3P+N systems, monitoring phase loss and phase sequence (not present in versions with "N" ending), overvoltage and undervoltage.

Power supply provided by the monitored mains. Delay on alarm, up to 30 s, for over/under voltage alarms.

### Main features

- Monitoring 3-phase mains with 3 wires (3P) or 4 wires (3P+N).
- Detection of the correct phase sequence (not present in versions with "N" ending) and phase loss.
- Front dial adjustable overvoltage and undervoltage setpoints.
- Time delay.
- Changeover relay output.

**Order code**

Mounting	Phase sequence detection	Power supply	Component name/part number
DIN-rail	Yes	208 to 240 VAC	DPB01CM23
		208 to 480 VAC	DPB01CM44
		380 to 480 VAC	DPB01CM48
	No	208 to 240 VAC	DPB01CM23N
		380 to 480 VAC	DPB01CM48N
Plug-in	Yes	208 to 240 VAC	PPB01CM23
		208 to 480 VAC	PPB01CM44
		380 to 480 VAC	PPB01CM48
	No	208 to 240 VAC	PPB01CM23N
		380 to 480 VAC	PPB01CM48N

**Structure**

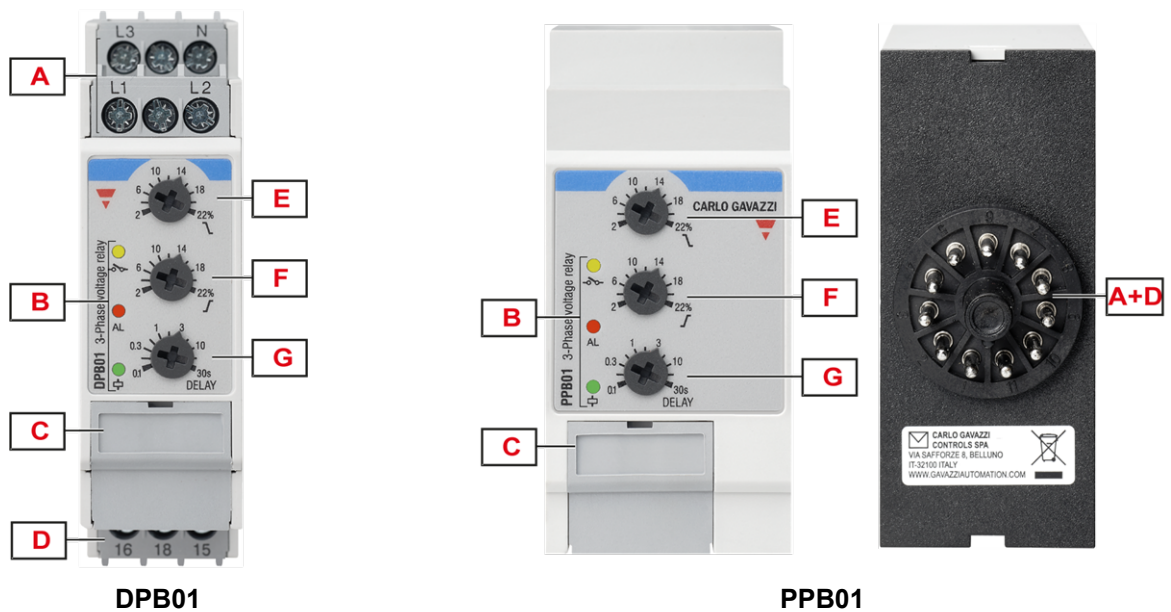

Element	Component	Function
A	Input terminals	Connection of the line voltages (neutral when present)
B	Information LEDs	Yellow for relay output status Red for signal alarm status Green for device ON
C	DIP switches	Setting the nominal voltage, type of mains, power ON delay
D	Output terminals	SPDT relay output
E	Undervoltage dial ( $\sim$ )	Undervoltage setpoint adjustment

Element	Component	Function
F	Overvoltage dial ( $\mathcal{J}$ )	Overvoltage setpoint adjustment
G	Delay time dial	Setting the alarm ON delay time

## Features

### Power supply

Power supply	Supplied by measured phases (L1, L2, L3)	
Overvoltage category	III (IEC 60664)	
Voltage range	DPB01CM23 DPB01CM23N PPB01CM23 PPB01CM23N	208 to 240 V <sub>L-L</sub> AC $\pm$ 15% (177 to 276 V)
	DPB01CM44 PPB01CM44	208 to 480 V <sub>L-L</sub> AC $\pm$ 15% (177 to 552 V)
	DPB01CM48 DPB01CM48N PPB01CM48 PPB01CM48N	380 to 480 V <sub>L-L</sub> AC $\pm$ 15% (323 to 552 V)
Frequency range	50 to 60 Hz $\pm$ 10% sinusoidal waveform <b>M44 only:</b> 50 to 400 Hz $\pm$ 10% sinusoidal waveform	
Consumption	< 2.5 VA	
Power ON delay	1 s $\pm$ 0.5 s or 6 s $\pm$ 0.5 s	

### Inputs

Terminals	<b>DPB01:</b> L1, L2, L3, N <b>PPB01:</b> 5, 6, 7, 11
Measured variables	Phase sequence (except for N versions) Phase loss 3P: voltages V <sub>L12</sub> , V <sub>L23</sub> , V <sub>L31</sub> 3P+N: voltages V <sub>L1N</sub> , V <sub>L2N</sub> , V <sub>L3N</sub>
Nominal line range	208 to 480 VAC $\pm$ 15% (177 to 550 VAC)

Nominal voltages (*)	DPB01CM23 DPB01CM23N PPB01CM23 PPB01CM23N	Delta voltage (3P)	208 V, 220 V, 230 V, 240 V
		Star voltage (3P+N)	120 V, 127 V, 133 V, 140 V
	DPB01CM44 PPB01CM44	Delta voltage (3P)	208 V, 220 V, 230 V, 240 V, 380 V, 400 V, 415 V, 480 V
		Star voltage (3P+N)	120 V, 127 V, 133 V, 140 V, 220 V, 230 V, 240 V, 277 V
	DPB01CM48 DPB01CM48N PPB01CM48 PPB01CM48N	Delta voltage (3P)	380 V, 400 V, 415 V, 480 V
		Star voltage (3P+N)	220 V, 230 V, 240 V, 277 V

(\*) **Note:** connect the neutral only if it is intrinsically at the star centre.

### ▶ Outputs

Terminals	DPB01: 15, 16, 18 PPB01: 1, 3, 4
Number of outputs	1
Type	SPDT electromechanical relay with changeover contacts
Logic	Output de-energised on alarm
Contact rating	lth: 8 A @ 250 VAC AC15: 2.5 A @ 250 VAC DC12: 5 A @ 24 VDC DC13: 2.5 A @ 24 VDC
Electrical lifetime	≥50 x 10 <sup>3</sup> operations (at 8 A, 250 V, cos φ= 1)
Mechanical lifetime	>30 x 10 <sup>6</sup> operations
Assignment	Associated to all alarm types

### ▶ Insulation

Terminals	Basic
Inputs: L1, L2, L3, N (DPB01) / 5, 6, 7, 11 (PPB01) to output: 15, 16, 18 (DPB01) / 1, 3, 4 (PPB01)	2.5 kVrms, 4 kV impulse 1.2/50 μs

**General**

<b>Material</b>	Polyamide (Nylon) (PA66/6) or Phenylene ether + Polystyrene (PPE-PS)
	Flammability rating: HB according to UL 94
<b>Colour</b>	RAL7035 (light grey)
<b>Dimensions (W x H x D)</b>	DPB01: 22.5 x 80 x 99.5 mm (0.89 x 3.15 x 3.92 in) PPB01: 36 x 80 x 94 mm (1.42 x 3.15 x 3.7 in)
<b>Weight</b>	150 g (5.29 oz)
<b>Terminals</b>	Cable size from 0.05 to 2.5 mm <sup>2</sup> (AWG30 to AWG13), stranded or solid
<b>Tightening torque</b>	Max. 0.5 Nm (4.425 lbin)
<b>Terminal type</b>	Double cage screw terminals (DPB01), Undecal Plug-in terminals (PPB01)

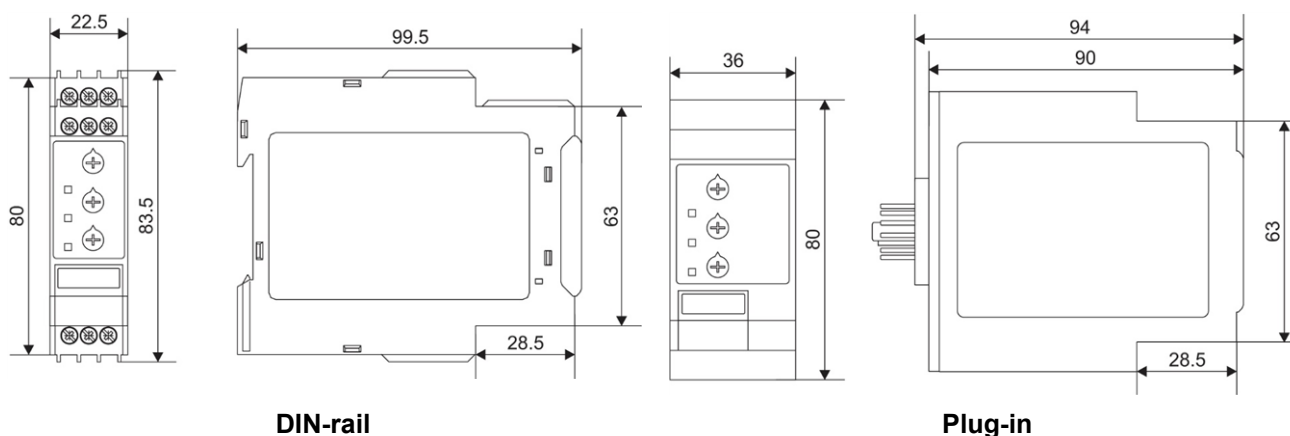

**DIN-rail**

**Plug-in**

**Environmental**

<b>Operating temperature</b>	-20 to 60 °C (-4 to 140 °F)
<b>Storage temperature</b>	-30 to 80 °C (-22 to 176 °F)
<b>Relative humidity</b>	5 - 95% non condensing
<b>Protection degree</b>	IP20
<b>Pollution degree</b>	2
<b>Operating max altitude</b>	2000 m amsl (6560 ft)
<b>Salinity</b>	Non saline environment
<b>UV resistance</b>	No







**Vibration/Shock resistance**

Test condition	Test	Level
Tests with unpacked device	Vibration response (IEC60255-21-1)	Class 1
	Vibration endurance (IEC 60255-21-1)	Class 1
	Shock (IEC 60255-21-2)	Class 1
	Bump (IEC 60255-21-2)	Class 1
Tests with packed device	Vibration random (IEC60068-2-64)	Class 1
	Shock (IEC 60255-21-2)	Class 1
	Bump (IEC 60255-21-2)	Class 1

Class 1: monitoring devices for normal use in power plants, substations and industrial plants and for normal transportation conditions.

The packaging type is designed and implemented in such manner that the severity class parameters will not be exceeded during transportation.

**Compatibility and conformity**

Marking	 
Directives	2014/35/EU (LVD - Low voltage) 2014/30/EU (EMC - Electromagnetic compatibility)
Standards	Insulation coordination: EN 60664-1 Immunity: EN61000-6-2 Emission: EN61000-6-3
Approvals	 (UL508, UL61010)  (GB/T14048.5) DPB01 only

**Operating description**

**DIP switches**

DIP switches		
Typology	DPB01CM44 PPB01CM44	6 switches (switch number 6 is unused) (Fig.1)
	DPB01CM23 DPB01CM23N PPB01CM23 PPB01CM23N DPB01CM48 DPB01CM48N PPB01CM48 PPB01CM48N	4 switches (Fig. 2 and 3)
Function	Power ON delay Mains type Mains voltage (M44: 8 ranges; M23 and M48: 4 ranges)	

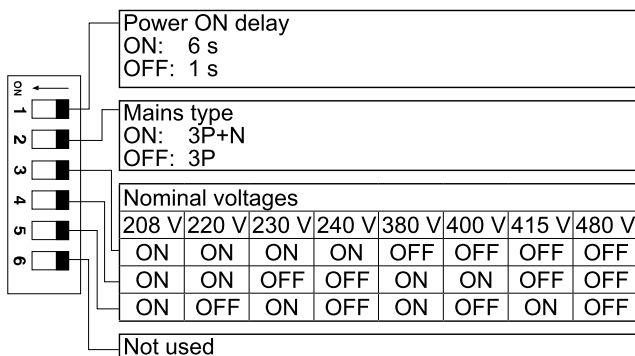

**Fig. 1** DIP switch settings table M44

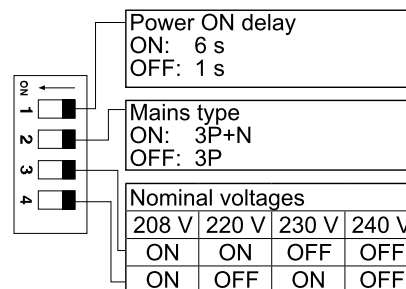

**Fig. 2** DIP switch settings table M23

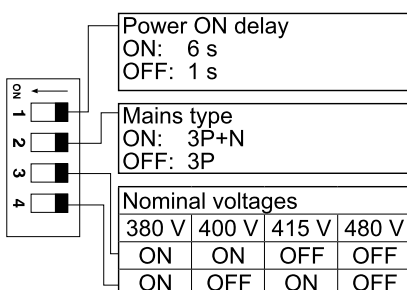

**Fig. 3** DIP switch settings table M48

## Device configuration

The relay operates when all the phases are present, the phase sequence is correct (not present in versions with N ending) and the phase-phase voltage levels are within set limits.

The relay releases when one or more phase-phase voltages exceeds the upper set level or drops below the lower set level.

Undervoltage adjustment dial	
Typology	Linear selection from 2 to 22%
Resolution	2% setpoint increase per notch
Function	Relative undervoltage setpoint

Overvoltage adjustment dial	
Typology	Linear selection from 2 to 22%
Resolution	2% setpoint increase per notch
Function	Relative overvoltage setpoint

Delay setting dial	
Typology	Logarithmic adjustment from 0.1 to 30 s
Resolution	From 100 ms/notch at 0.1 s to 10 s/notch at 30 s
Function	Alarm ON delay setting for undervoltage and overvoltage

## Alarms

DPB01 and PPB01 operate in 2 different modes depending upon the alarm type:

- Phase loss and incorrect phase sequence cause immediate output relay de-energisation.
- Under or over voltage triggering cause output relay to turn OFF at the end of set delay.

Phase loss alarm	
Input variables	L1-L2, L2-L3 and L3-L1
Alarm setpoint	One phase $\leq$ 85% of the rated value (regenerated voltage detection)
Restore setpoint	All phases $>$ 85% of the rated value + Hysteresis
Reaction time	$\leq$ 200 ms
Hysteresis	2% fixed
Delay ON	None
Delay OFF	None

Phase sequence alarm	
Input variables	Connection L1, L2, L3
Reaction time	$\leq$ 200 ms
Delay ON	None
Delay OFF	None

Over / under voltage alarms	
<b>Input variables</b>	3P: voltages $V_{L12}, V_{L23}, V_{L31}$ 3P+N: voltages $V_{L1N}, V_{L2N}, V_{L3N}$
<b>Reaction time</b>	$\leq 200$ ms + set delay ON alarm
<b>Undervoltage setting range</b>	From -2 to -22%
<b>Overvoltage setting range</b>	From 2 to 22%
<b>Repeatability</b>	1% reading + 1 V
<b>Hysteresis</b>	Setpoint between 2% and 5% $\rightarrow$ Hys 1% Setpoint between 5% and 22% $\rightarrow$ Hys 2%
<b>Delay ON</b>	Adjustable: from 0.1 to 30 s Accuracy: from $\pm 50$ ms at 0.1 s to $\pm 5$ s at 30 s Repeatability: from $\pm 10$ ms at 0.1 s to $\pm 1$ s at 30 s
<b>Delay OFF</b>	None

### Information LEDs

Colour	Status	Description	
<b>Green</b> ( $\ominus$ )	Power supply	ON	Power supply ON
		OFF	Power supply OFF
<b>Red</b> (AL)	Alarm	ON (steady)	Alarm situation is still present at the end of delay
		OFF	Alarm OFF
		Flashing 2 Hz	Under or overvoltage alarm triggered with a delay on alarm elapsing
		Flashing 5 Hz	Phase loss or incorrect phase sequence alarm
<b>Yellow</b> ( $\text{---} \circ \text{---}$ )	Relay output	ON	Energised
		OFF	De-energised

### Operating diagram

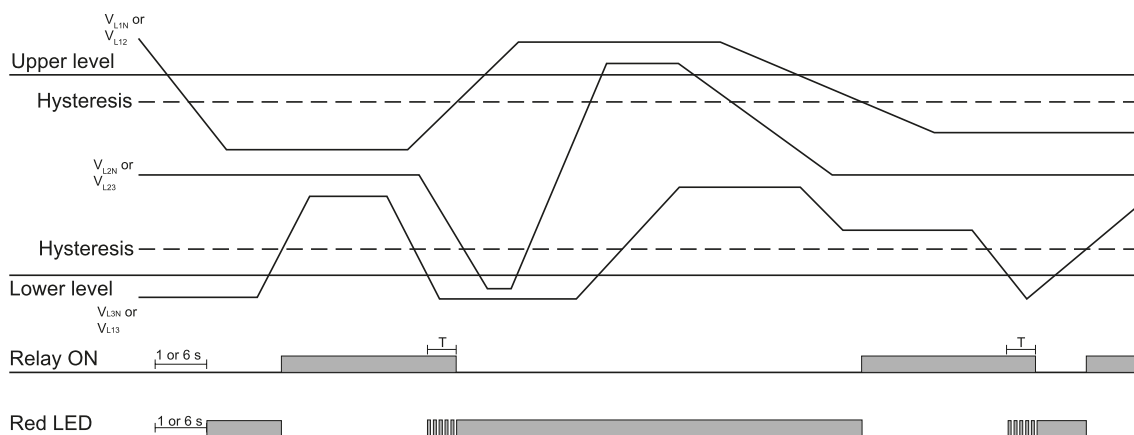

Over and undervoltage monitoring

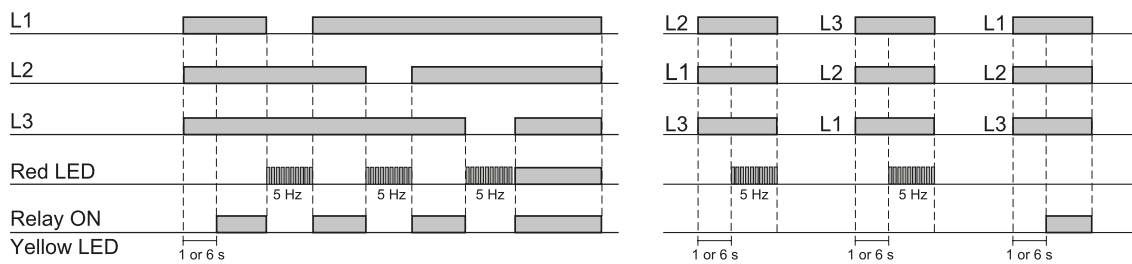

Total phase loss, phase sequence

## Connection diagrams

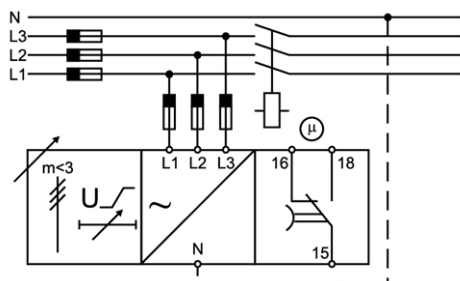

DPB01

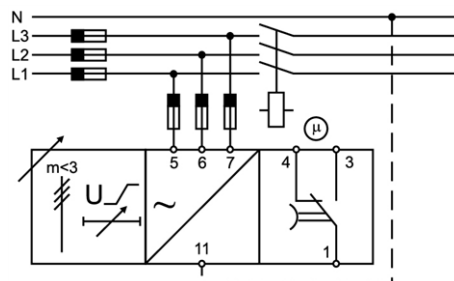

PPB01

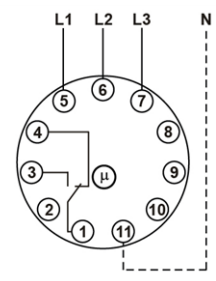

## References

### Further reading

Information	Document	Where to find it
Installation manual	XPB01-XPB01N_IM.pdf	<a href="https://carlogavazzi-pss.com/manuals/DPB01_PPB01_IM_html">https://carlogavazzi-pss.com/manuals/DPB01_PPB01_IM_html</a>



COPYRIGHT ©2022

Content subject to change. Download the PDF: [www.productselection.net](http://www.productselection.net)