

DPA51, DPA71

3-Phase voltage monitoring relay



Benefits

- **Wide voltage range.** Working in systems from 208 to 480 VAC.
- **Output and status LED indication.** For quick troubleshooting.
- **Regenerated voltage detection.** To detect phase loss even while the motor is running.
- **High Compactness.** 17.5 mm (DPA51) and 35.5 mm (DPA71) DIN-rail housing.

Description

DPA51 and DPA71 are 3-phase mains monitoring relays.

They operate on 3P systems, monitoring phase loss and phase sequence.

Power supply provided by the monitored mains.

For mounting on DIN-rail.

Main features

- Monitoring 3-phase mains with 3 wires (3P).
- Detection of the correct phase sequence and phase loss.
- Changeover relay output.

Order code

Mounting	Power supply	Component name/part number
DIN-rail	208 to 240 VAC	DPA71DM23
	208 to 480 VAC	DPA51CM44
	380 to 480 VAC	DPA71DM48



Structure

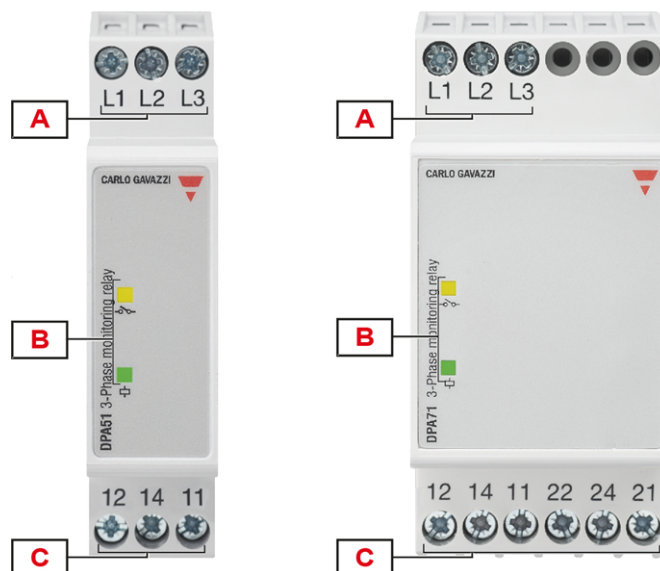

Element	Component	Function
A	Input terminals	Connection of the line voltages
B	Information LEDs	Yellow for relay output status Green for device ON
C	Output terminals	SPDT relay output (DPA51) DPDT relay output (DPA71)

Features

Power supply

Power supply	Supplied by measured phases (L2, L3)	
Overvoltage category	III (IEC 60664)	
Voltage range	DPA71DM23	208 to 240 V _{L-L} AC ± 15% (177 to 276 V)
	DPA51CM44	208 to 480 V _{L-L} AC ± 15% (177 to 552 V)
	DPA71DM48	380 to 480 V _{L-L} AC ± 15% (323 to 552 V)
Frequency range	50 to 60 Hz ± 10% sinusoidal waveform	
Consumption	DPA71DM23	< 6 VA
	DPA51CM44	< 13 VA
	DPA71DM48	< 10 VA

Inputs

Terminals	L1, L2, L3	
Measured variables	Phase sequence Phase loss 3P: voltages V_{L12} , V_{L23} , V_{L31}	
Nominal line range	DPA71DM23	208 to 240 VAC $\pm 15\%$ (177 to 276 VAC)
	DPA51CM44	208 to 480 VAC $\pm 15\%$ (177 to 552 VAC)
	DPA71DM48	380 to 480 VAC $\pm 15\%$ (323 to 552 VAC)

Outputs

Terminals	DPA51	11, 12, 14
	DPA71	11, 12, 14, 21, 22, 24
Number of outputs	DPA51	1
	DPA71	2
Type	DPA51	SPDT electromechanical relay with changeover contacts
	DPA71	DPDT electromechanical relay with changeover contacts
Logic	Output de-energised on alarm	
Contact rating	DPA51	DC12: 5 A @ 24 VDC AC15: 2.5 A @ 250 VAC DC13: 2.5 A @ 24 VDC
	DPA71	Ith: 5 A @ 250 VAC AC15: 3 A @ 250 VAC DC13: 2 A @ 24 VDC
Electrical lifetime	$\geq 50 \times 10^3$ operations (at 5 A, 250 V, $\cos \varphi = 1$)	
Mechanical lifetime	$> 30 \times 10^6$ operations	
Assignment	Associated to all alarm types	

Insulation

Terminals		Basic insulation
Inputs: L1, L2, L3 to output: 11, 12, 14	DPA51	2.5 kVrms, 4 kV impulse 1.2/50 μ s
Inputs: L1, L2, L3 to outputs: 11, 12, 14, 21, 22, 24	DPA71	

General

Material	Polyamide (Nylon) (PA66/6) or Phenylene ether + Polystyrene (PPE-PS)
	Flammability rating: HB according to UL 94
Colour	RAL7035 (light grey)
Dimensions (W x H x D)	DPA51: 17.5 x 81 x 67.2 mm (0.68 x 3.19 x 2.65 in)
	DPA71: 35.5 x 81 x 67.2 mm (1.40 x 3.19 x 2.65 in)
Weight	DPA51: approx. 75 g (2.65 oz)
	DPA71: approx. 150 g (5.29 oz)
Terminals	Cable size from 0.05 to 2.5 mm ² (AWG30 to AWG13), stranded or solid
Tightening torque	Max. 0.5 Nm (4.425 lbin)
Terminal type	Screw terminals

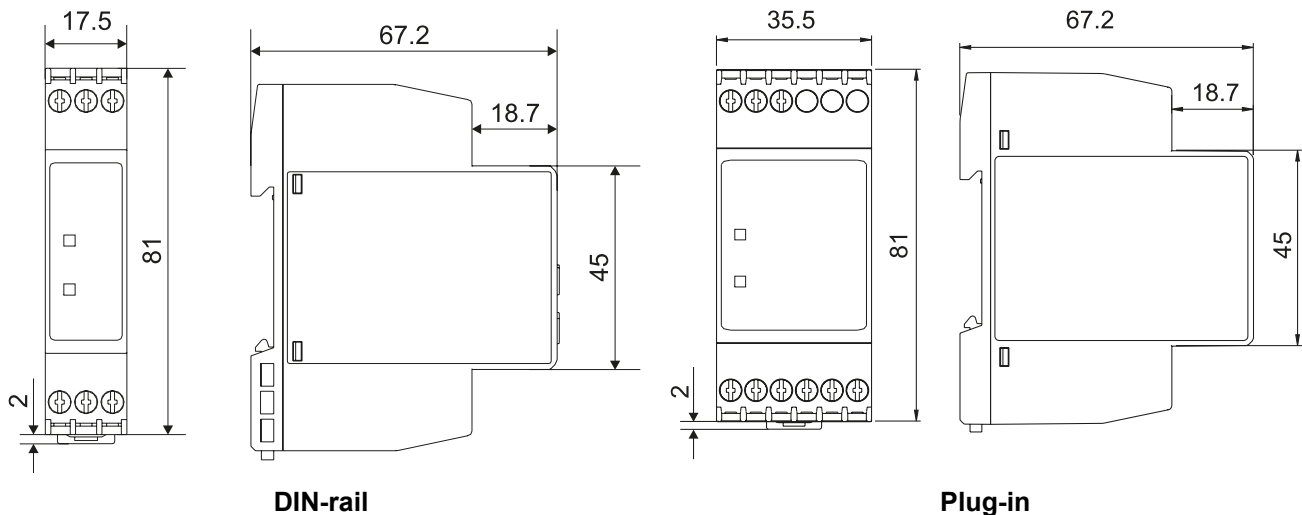

Environmental

Operating temperature	DPA51: -20 to 60 °C (-4 to 140 °F)
	DPA71: -20 to 50 °C (-4 to 122 °F)
Storage temperature	-30 to 80 °C (-22 to 176 °F)
Relative humidity	5 - 95% non condensing
Protection degree	IP20
Pollution degree	2
Operating max altitude	2000 m amsl (6560 ft)
Salinity	Non saline environment
UV resistance	No











Vibration/Shock resistance

Test condition	Test	Level
Tests with unpacked device	Vibration response (IEC60255-21-1)	Class 1
	Vibration endurance (IEC 60255-21-1)	Class 1
	Shock (IEC 60255-21-2)	Class 1
	Bump (IEC 60255-21-2)	Class 1
Tests with packed device	Vibration random (IEC60068-2-64)	Class 1
	Shock (IEC 60255-21-2)	Class 1
	Bump (IEC 60255-21-2)	Class 1

Class 1: monitoring devices for normal use in power plants, substations and industrial plants and for normal transportation conditions.

The packaging type is designed and implemented in such manner that the severity class parameters will not be exceeded during transportation.

Compatibility and conformity

Marking	 		
Directives	2014/35/EU (LVD - Low voltage) 2014/30/EU (EMC - Electromagnetic compatibility)		
Standards	Insulation coordination: EN 60664-1 Immunity: EN61000-6-2 Emission: EN61000-6-3		
Approvals	DPA51CM44	   	
	DPA71DM23 DPA71DM48	 	

Operating description

Device configuration

The relay operates when all the phases are present and the phase sequence is correct.

Alarms

- Phase loss and incorrect phase sequence cause immediate output relay de-energisation.

Phase loss alarm	
Input variables	L1-L2, L2-L3 and L3-L1
Alarm setpoint	One phase $\leq 85\%$ of the rated value (regenerated voltage detection)
Restore setpoint	All phases $> 85\%$ of the rated value + Hysteresis
Hysteresis	2% fixed
Delay ON	< 100 ms
Delay OFF	< 300 ms

Phase sequence alarm	
Input variables	Connection L1, L2, L3
Reaction time	≤ 200 ms
Delay ON	< 100 ms
Delay OFF	< 300 ms

Information LEDs

Colour	Status	Description
Green (\oplus)	Power supply	ON
		OFF
Yellow (\ominus)	Relay output	ON
		OFF

Operating diagram

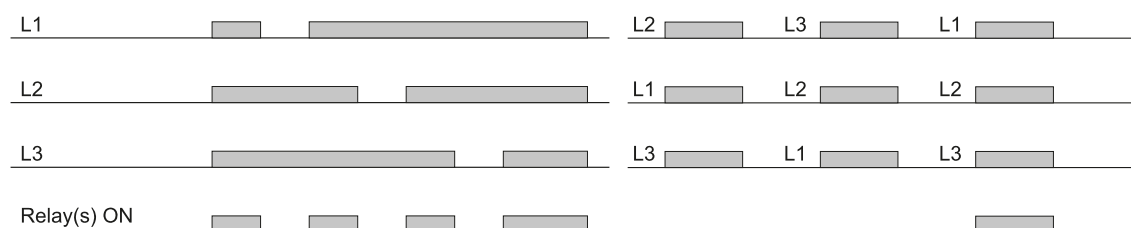
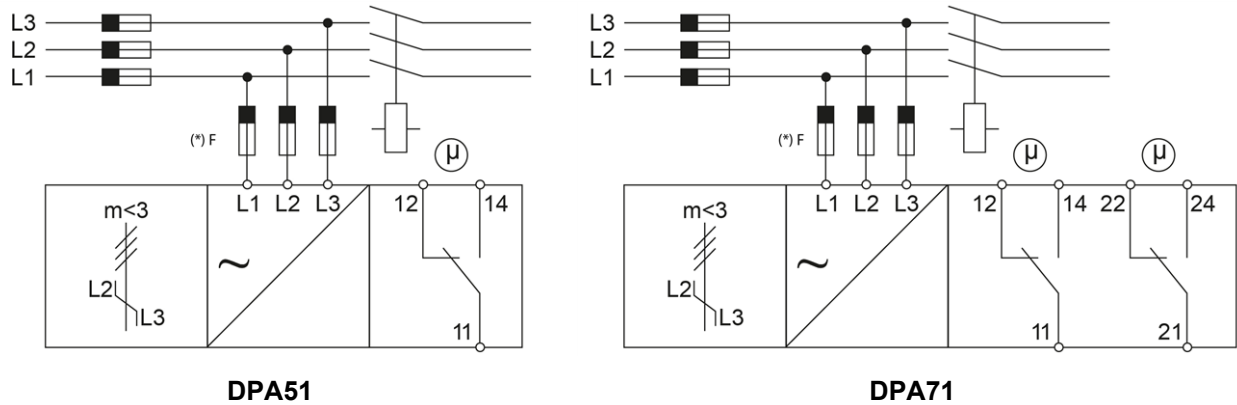

Fig. 1 Total phase loss, phase sequence



Connection diagrams

(*) NOTE: fuses F of 315 mA delayed, if required by local law.



References

Further reading

Information	Where to find it	QR code
Installation manual	https://carlogavazzi-pss.com/manuals/DPA_PPA_IM_html	
PSS selection tool	https://carlogavazzi-pss.com/	



COPYRIGHT ©2024

Content subject to change. Download the PDF: www.gavazziautomation.com